



# PSN01-2501

deTem

**SAFETY MULTIBEAM SENSORS**

**SICK**  
Sensor Intelligence.



### Ordering information

Low scanning range

Number of beams	Beam separation	Scanning range	System part	Type	Part no.
2	500 mm	3.2 m	Passive unit	PSN01-2501	1101921

Other models and accessories → [www.sick.com/deTem](http://www.sick.com/deTem)



### Detailed technical data

#### Features

<b>Application</b>	Normal industrial environment
<b>Functional principle</b>	Active/passive
<b>System part</b>	Passive unit
<b>Type of diversion</b>	Fibre-optic deflection
<b>Scanning range category</b>	Low scanning range
<b>Scanning range</b>	3.2 m
<b>Dimension of the light path</b>	Typical 0.5 m ... 3.2 m
<b>Number of beams</b>	2
<b>Beam separation</b>	500 mm
<b>Items supplied</b>	Passive unit

#### Mechanical data

<b>Dimensions</b>	See dimensional drawing
<b>Housing cross-section</b>	30.7 mm x 34 mm
<b>Material</b>	Housing Aluminum extruded profile Front screen Polycarbonate, scratch-resistant coating
<b>Weight</b>	+ 520 g (± 50 g)

#### Ambient data

<b>Enclosure rating</b>	IP65 (IEC 60529) IP67 (IEC 60529)
<b>Ambient operating temperature</b>	-30 °C ... +55 °C
<b>Storage temperature</b>	-30 °C ... +70 °C
<b>Air humidity</b>	15 % ... 95 %, Non-condensing
<b>Vibration resistance</b>	5 g, 10 Hz ... 55 Hz (IEC 60068-2-6)
<b>Shock resistance</b>	10 g, 16 ms (IEC 60068-2-27)

## Classifications

<b>eCl@ss 5.0</b>	27272703
<b>eCl@ss 5.1.4</b>	27272703
<b>eCl@ss 6.0</b>	27272703
<b>eCl@ss 6.2</b>	27272703
<b>eCl@ss 7.0</b>	27272703
<b>eCl@ss 8.0</b>	27272703
<b>eCl@ss 8.1</b>	27272703
<b>eCl@ss 9.0</b>	27272703
<b>eCl@ss 10.0</b>	27272703
<b>eCl@ss 11.0</b>	27272703
<b>eCl@ss 12.0</b>	27272703
<b>ETIM 5.0</b>	EC001832
<b>ETIM 6.0</b>	EC001832
<b>ETIM 7.0</b>	EC001832
<b>ETIM 8.0</b>	EC001832
<b>UNSPSC 16.0901</b>	46171620

## Dimensional drawing (Dimensions in mm (inch))



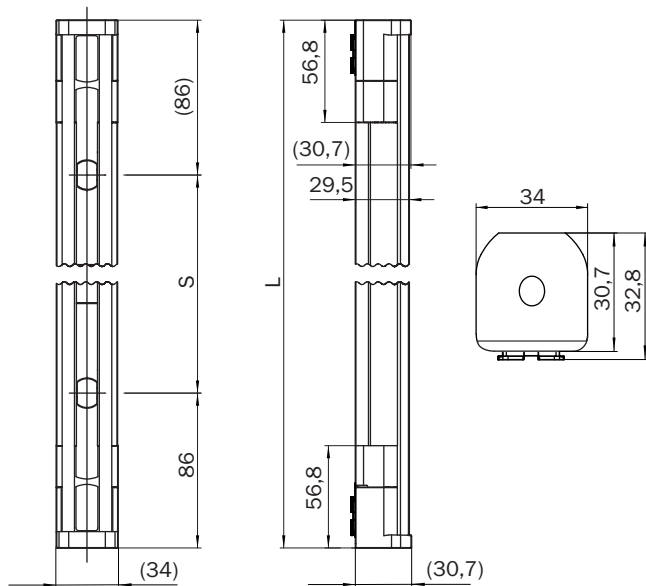



Passive unit for small sensing range (fiber deflection)

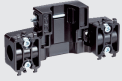

Number of beams	Beam separation S	L
2	500	672
4	300	1.072

### Recommended accessories

Other models and accessories → [www.sick.com/deTem](http://www.sick.com/deTem)

	Brief description	Type	Part no.
<b>Muting accessories</b>			
	Sensor bracket G6 and P250	BEF-2KHAAKU1	2113145
	Universal holder for round steel arms and muting arms, for mounting sensors or reflectors	BEF-KHS-N01	2044953
	Muting arm bracket	Muting arm bracket	2106455
	Muting arm, long	Muting arm, long	2111923
	Muting arm, short	Muting arm, short	2111924
<b>Terminal and alignment brackets</b>			
	4 pieces, FlexFix bracket for 2 devices (e.g. sender and receiver), can be aligned $\pm 15^\circ$ , including M5 screw, plastic	BEF-1SHABPKU4	2066614
	4 pieces, QuickFix bracket for 2 devices (e.g. sender and receiver), plastic	BEF-3SHABPKU4	2098710

## SICK AT A GLANCE

SICK is one of the leading manufacturers of intelligent sensors and sensor solutions for industrial applications. A unique range of products and services creates the perfect basis for controlling processes securely and efficiently, protecting individuals from accidents and preventing damage to the environment.

We have extensive experience in a wide range of industries and understand their processes and requirements. With intelligent sensors, we can deliver exactly what our customers need. In application centers in Europe, Asia and North America, system solutions are tested and optimized in accordance with customer specifications. All this makes us a reliable supplier and development partner.

Comprehensive services complete our offering: SICK LifeTime Services provide support throughout the machine life cycle and ensure safety and productivity.

For us, that is “Sensor Intelligence.”

## WORLDWIDE PRESENCE:

Contacts and other locations –[www.sick.com](http://www.sick.com)