



# GL6-N1211P14

G6

MINIATURE PHOTOELECTRIC SENSORS

**SICK**  
Sensor Intelligence.



### Ordering information

Type	Part no.
GL6-N1211P14	1102680

**Included in delivery:** PL20A (1)

Other models and accessories → [www.sick.com/G6](http://www.sick.com/G6)

Illustration may differ



### Detailed technical data

#### Features

<b>Functional principle</b>	Photoelectric retro-reflective sensor	
<b>Functional principle detail</b>	Dual lens	
<b>Sensing range max.</b>	≤ 6 m <sup>1)</sup>	
<b>Sensing range</b>	≤ 5 m <sup>1)</sup>	
<b>Polarisation filters</b>	Yes	
<b>Emitted beam</b>	Light source	PinPoint LED <sup>2)</sup>
	Type of light	Visible red light
	Light spot size (distance)	Ø 8 mm (350 mm)
<b>Key LED figures</b>	Wave length	650 nm
<b>Adjustment</b>	Potentiometer, 270°	
<b>Items supplied</b>	Reflector PL20A	

<sup>1)</sup> Reflector PL80A.

<sup>2)</sup> Average service life: 100,000 h at T<sub>J</sub> = +25 °C.

## Electrical data

<b>Supply voltage <math>U_b</math></b>	10 V DC ... 30 V DC <sup>1)</sup>
<b>Ripple</b>	$\pm 10\%$ <sup>2)</sup>
<b>Current consumption</b>	30 mA <sup>3)</sup>
<b>Protection class</b>	III
<b>Digital output</b>	
Type	NPN
Signal voltage NPN HIGH/LOW	Approx. $V_S / \leq 3\text{ V}$
Output current $I_{max}$	$\leq 100\text{ mA}$ <sup>4)</sup>
Response time	$< 625\ \mu\text{s}$ <sup>5)</sup>
Switching frequency	1,000 Hz <sup>6)</sup>
<b>Switching mode</b>	Light/dark switching
<b>Switching mode selector</b>	Selectable via light/dark selector
<b>Circuit protection</b>	A <sup>7)</sup> B <sup>8)</sup> D <sup>9)</sup>

<sup>1)</sup> Limit values when operated in short-circuit protected network: max. 8 A.

<sup>2)</sup> May not exceed or fall below  $U_v$  tolerances.

<sup>3)</sup> Without load.

<sup>4)</sup> At  $U_v > 24\text{ V}$ ,  $I_A\text{ max.} = 50\text{ mA}$ .

<sup>5)</sup> Signal transit time with resistive load.

<sup>6)</sup> With light/dark ratio 1:1.

<sup>7)</sup> A =  $V_S$  connections reverse-polarity protected.

<sup>8)</sup> B = inputs and output reverse-polarity protected.

<sup>9)</sup> D = outputs overcurrent and short-circuit protected.

## Mechanical data

<b>Housing</b>	Rectangular
<b>Dimensions (W x H x D)</b>	12 mm x 31.5 mm x 21 mm
<b>Connection</b>	Cable, 3-wire, 2 m <sup>1)</sup>
<b>Connection detail</b>	
Length of cable (L)	2 m <sup>1)</sup>
<b>Material</b>	
Housing	Plastic, ABS/PC
Front screen	Plastic, PMMA
Cable	PVC
<b>Weight</b>	60 g

<sup>1)</sup> Do not bend below 0 °C.

## Ambient data

<b>Enclosure rating</b>	IP67
<b>Ambient operating temperature</b>	-25 °C ... +55 °C <sup>1)</sup>
<b>Ambient temperature, storage</b>	-40 °C ... +70 °C

<sup>1)</sup> Temperature stability following adjustment +/-10 °C.

<b>UL File No.</b>	NRKH.E348498 & NRKH7.E348498
--------------------	------------------------------

<sup>1)</sup> Temperature stability following adjustment +/-10 °C.

### Classifications

<b>eCl@ss 5.0</b>	27270902
<b>eCl@ss 5.1.4</b>	27270902
<b>eCl@ss 6.0</b>	27270902
<b>eCl@ss 6.2</b>	27270902
<b>eCl@ss 7.0</b>	27270902
<b>eCl@ss 8.0</b>	27270902
<b>eCl@ss 8.1</b>	27270902
<b>eCl@ss 9.0</b>	27270902
<b>eCl@ss 10.0</b>	27270902
<b>eCl@ss 11.0</b>	27270902
<b>eCl@ss 12.0</b>	27270902
<b>ETIM 5.0</b>	EC002717
<b>ETIM 6.0</b>	EC002717
<b>ETIM 7.0</b>	EC002717
<b>ETIM 8.0</b>	EC002717
<b>UNSPSC 16.0901</b>	39121528

### Connection type

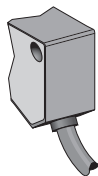

### Connection diagram

Cd-043

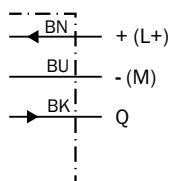

### Characteristic curve

GL6

Operating reserve



- ① Reflector PL80A
- ② Reflector PL40A
- ③ Reflector P250
- ④ Reflector PL20A
- ⑤ Reflective tape REF-IRF-56

### Light spot size

GL6, GL6G



### Sensing range diagram

GL6, GL6G



■ Sensing range

■ Sensing range max.

- ① Reflector PL80A
- ② Reflector PL40A
- ③ Reflector P250
- ④ Reflector PL20A
- ⑤ Reflective tape REF-IRF-56

### Adjustments

Adjustment possibility

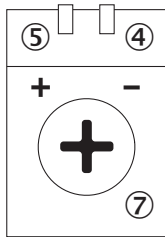

- ④ LED indicator green: Supply voltage active
- ⑤ LED indicator yellow: Status of received light beam
- ⑦ Sensitivity control: potentiometer



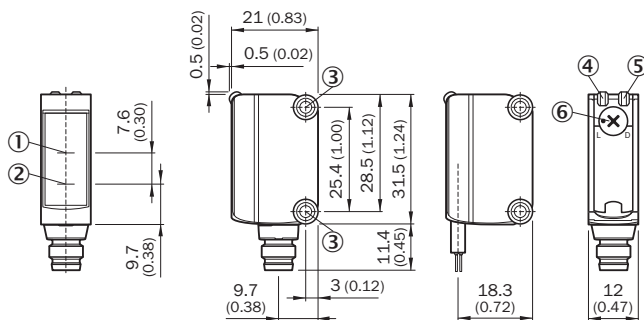

### Dimensional drawing (Dimensions in mm (inch))



- ① Optical axis, receiver
- ② Optical axis, sender
- ③ Mounting holes M3
- ④ LED indicator green: Supply voltage active
- ⑤ LED indicator yellow: Status of received light beam
- ⑥ Light/ dark rotary switch: L = light switching, D = dark switching

## Recommended accessories

Other models and accessories → [www.sick.com/G6](http://www.sick.com/G6)

	Brief description	Type	Part no.
Universal bar clamp systems			
	Clamp bar to fix G6 sensors on rods of 12 mm, clamp-on design up to 4 mm wall thickness, aluminum (clamp bar), stainless steel (bracket), clamp bar mounting and clamp function, mounting bracket, mounting hardware	BEF-KHS-IS12G6	2086865
Mounting brackets and plates			
	Stainless steel (1.4301)	BEF-WN-G6	2062909
	Universal mounting bracket for reflectors, steel, zinc coated	BEF-WN-REFX	2064574
Plug connectors and cables			
	Head A: male connector, M8, 3-pin, straight Cable: unshielded	STE-0803-G	6037322
Reflectors			
	Rectangular, screw connection, 51 mm x 61 mm, PMMA/ABS, Screw-on, 2 hole mounting	P250	5304812

## SICK AT A GLANCE

SICK is one of the leading manufacturers of intelligent sensors and sensor solutions for industrial applications. A unique range of products and services creates the perfect basis for controlling processes securely and efficiently, protecting individuals from accidents and preventing damage to the environment.

We have extensive experience in a wide range of industries and understand their processes and requirements. With intelligent sensors, we can deliver exactly what our customers need. In application centers in Europe, Asia and North America, system solutions are tested and optimized in accordance with customer specifications. All this makes us a reliable supplier and development partner.

Comprehensive services complete our offering: SICK LifeTime Services provide support throughout the machine life cycle and ensure safety and productivity.

For us, that is “Sensor Intelligence.”

## WORLDWIDE PRESENCE:

Contacts and other locations –[www.sick.com](http://www.sick.com)