



M40S-072200AR0

M4000 Standard

SAFETY MULTIBEAM SENSORS

SICK
Sensor Intelligence.



Illustration may differ



Ordering information

Scanning range	Number of beams	Beam separation	System part	Type	Part no.
0.5 m ... 70 m, configurable	7	220 mm	Sender	M40S-072200ARO	1200009

Other models and accessories → www.sick.com/M4000_Standard

Detailed technical data

Features

Scanning range	0.5 m ... 70 m, configurable
Low scanning range	0.5 m ... 20 m
Great scanning range	9 m ... 70 m
Number of beams	7
Beam separation	220 mm
Response time	11 ms
Synchronization	Optical synchronisation
Specialty	Without additional options

Safety-related parameters

Type	Type 4 (IEC 61496-1)
Safety integrity level	SIL3 (IEC 61508)
Category	Category 4 (EN ISO 13849)
Performance level	PL e (EN ISO 13849)
PFH_D (mean probability of a dangerous failure per hour)	6.6×10^{-9} (EN ISO 13849)
T_M (mission time)	20 years (EN ISO 13849)
Safe state in the event of a fault	At least one OSSD is in the OFF state.

Functions

	Functions	Delivery status
Beam coding	✓	Uncoded
Sender test	✓	Deactivated
Configurable scanning range	✓	

Interfaces

System connection	Male connector M12, 8-pin
--------------------------	---------------------------

¹⁾ Depending on load, power supply and wire cross-section. The technical specifications must be observed.

Permitted cable length	15 m ¹⁾
Permitted cross-section	≥ 0.25 mm ²
Configuration method	Configuration buttons
Display elements	LEDs 7-segment display

¹⁾ Depending on load, power supply and wire cross-section. The technical specifications must be observed.

Electrical data

Protection class	III (IEC 61140)
Supply voltage V_S	24 V DC (19.2 V DC ... 28.8 V DC) ¹⁾
Residual ripple	≤ 10 % ²⁾
Power consumption	≤ 0.2 A

¹⁾ The external voltage supply must be capable of buffering brief mains voltage failures of 20 ms as specified in EN 60204-1. Suitable power supplies are available as accessories from SICK.

²⁾ Within the limits of V_S.

Mechanical data

Dimensions	See dimensional drawing
Housing cross-section	52 mm x 55.5 mm
Material	
Housing	Aluminum alloy ALMGSI 0.5, powder coated
Front screen	Polycarbonate, scratch-resistant coating

Ambient data

Enclosure rating	IP65 (EN 60529)
Ambient operating temperature	-30 °C ... +55 °C
Storage temperature	-30 °C ... +70 °C
Air humidity	15 % ... 95 %, Non-condensing
Shock resistance	10 g, 16 ms (IEC 60068-2-29)

Other information

Wave length	950 nm
--------------------	--------

Classifications

eCl@ss 5.0	27272703
eCl@ss 5.1.4	27272703
eCl@ss 6.0	27272703
eCl@ss 6.2	27272703
eCl@ss 7.0	27272703
eCl@ss 8.0	27272703
eCl@ss 8.1	27272703
eCl@ss 9.0	27272703
eCl@ss 10.0	27272703
eCl@ss 11.0	27272703
eCl@ss 12.0	27272703
ETIM 5.0	EC001832

M40S-072200ARO | M4000 Standard

SAFETY MULTIBEAM SENSORS

ETIM 6.0	EC001832
ETIM 7.0	EC001832
ETIM 8.0	EC001832
UNSPSC 16.0901	46171620

Dimensional drawing (Dimensions in mm (inch))

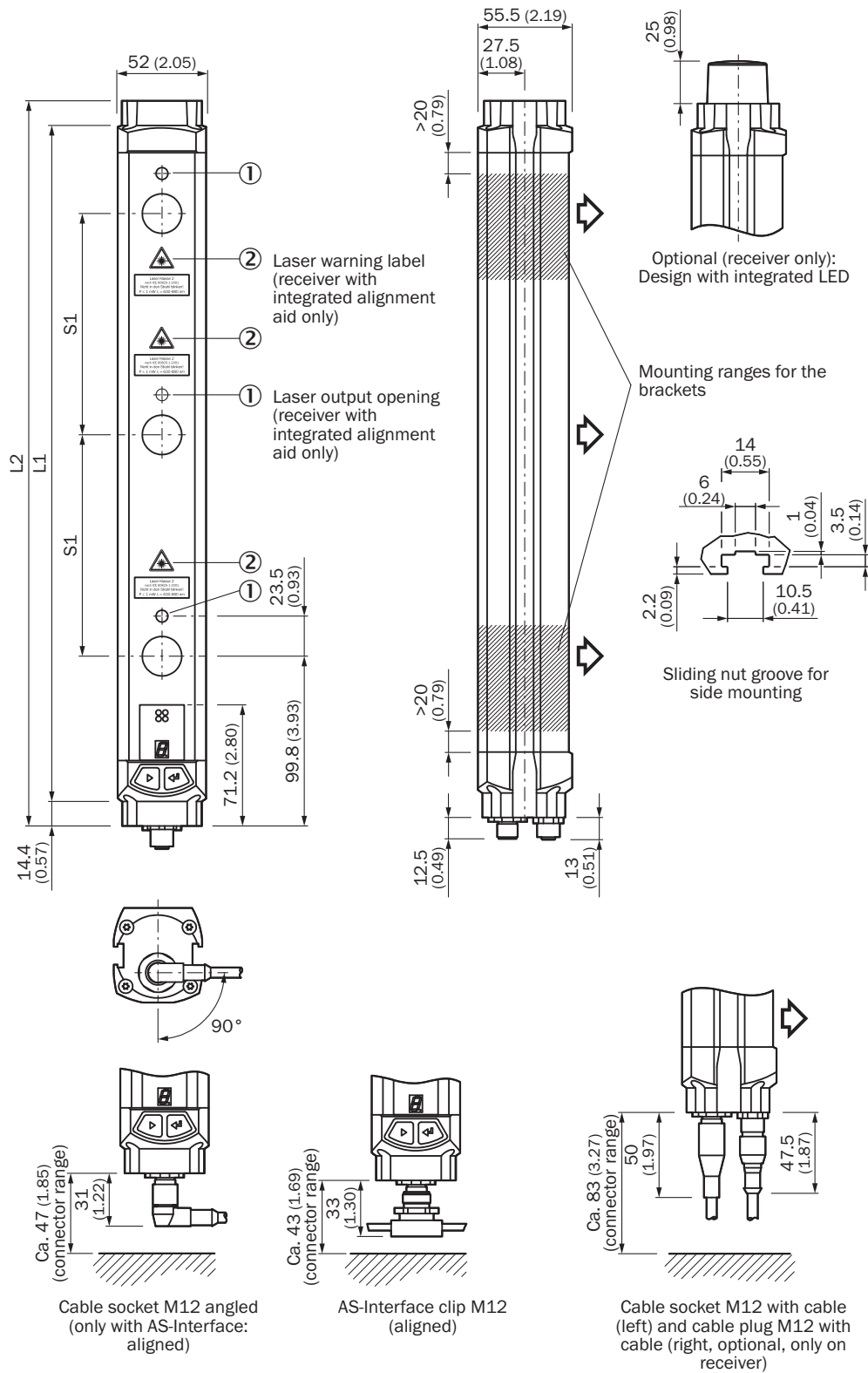







Illustration sender (receiver mirror image)

Number of beams	Beam separation S1	L1	L2
2	500 (19.69)	643 (25.31)	672 (26.46)

Number of beams	Beam separation S1	L1	L2
3	600 (23.62)	743 (29.25)	772 (30.39)
	220 (8.66)	583 (22.95)	612 (24.09)
	400 (15.75)	943 (37.13)	972 (38.27)
4	450 (17.72)	1,043 (41.06)	1,072 (42.20)
	220 (8.66)	803 (31.61)	832 (32.76)
	300 (11.81)	1,043 (41.06)	1,072 (42.20)
5	220 (8.66)	1,023 (40.28)	1,052 (41.42)
6		1,243 (48.94)	1,272 (50.08)
7		1,462 (57.56)	1,491 (58.70)
8		1,682 (66.22)	1,711 (67.36)

Recommended accessories

Other models and accessories → www.sick.com/M4000_Standard

	Brief description	Type	Part no.
Alignment aids			
	Laser alignment aid for various sensors, laser class 2 (IEC 60825). Do not look into the beam!, 19 mm x 67.3 mm x 66.9 mm	AR60	1015741
	Adapter AR60 for M4000 and M4000 Curtain	AR60 adapter, M4000	4040006
Mounting brackets and plates			
	4 pieces, Mounting kit 1, mounting bracket, rigid, L-shaped, including fixing screws and washers	BEF-3WNGBAST4	7021352
Terminal and alignment brackets			
	4 pieces, Mounting kit 6, side bracket, rotatable, zinc diecast	BEF-1SHABAZN4	2019506
	4 pieces, Mounting kit 12, rotatable, swivel mount	BEF-2SMGEAKU4	2030510

SICK AT A GLANCE

SICK is one of the leading manufacturers of intelligent sensors and sensor solutions for industrial applications. A unique range of products and services creates the perfect basis for controlling processes securely and efficiently, protecting individuals from accidents and preventing damage to the environment.

We have extensive experience in a wide range of industries and understand their processes and requirements. With intelligent sensors, we can deliver exactly what our customers need. In application centers in Europe, Asia and North America, system solutions are tested and optimized in accordance with customer specifications. All this makes us a reliable supplier and development partner.

Comprehensive services complete our offering: SICK LifeTime Services provide support throughout the machine life cycle and ensure safety and productivity.

For us, that is “Sensor Intelligence.”

WORLDWIDE PRESENCE:

Contacts and other locations –www.sick.com