



DAXLVN-0600BA080000M01

DAX®

SICK
Sensor Intelligence.



Illustration may differ

Ordering information

Type	Part no.
DAXLVN-0600BA080000M01	1133526

Mounting brackets and position magnet enclosed. Mounting material for base not included.

Other models and accessories → www.sick.com/DAX



Detailed technical data

Performance

Linearity	≤ 0.03% F.S. (Minimum 90 µm) ^{1) 2)}
Repeatability	≤ ± 20 µm
Measured values	Positioning
Measuring range	0 mm ... 600 mm
Unusable range	
Null zone	55 mm
Damping zone	63 mm
Magnet type	
Magnet shape	Block magnet
Number of magnets	1 piece
Magnet travel speed	Any
Measuring frequency (internal)	< 2 ms

¹⁾ Systematic position measurement deviation according to DIN ISO 1319-1 (value includes all systematic errors or deviations from the actual position value, e.g. repeatability and hysteresis).

²⁾ In principle, the size of the measurement deviation is limited by the resolution of the interface.

Interfaces

Communication interface	Analog
Communication Interface detail	Voltage
Output signal	0 V DC ... 10 V DC
Signals	
Number of signals	2 output signals (one output signal + an inverted second output signal)
Sequence of signals	Signal 1: rising, signal 2: falling

Electrical data

Connection type	Male connector, M12, 8-pin
Male connector coding	A-coded
Supply voltage	24 V DC (± 20%)
Reverse polarity protection	Up to -30 V DC

¹⁾ This product is a standard product and does not constitute a safety component as defined in the Machinery Directive. Calculation based on nominal load of components, average ambient temperature 40°C, frequency of use 8760 h/a. All electronic failures are considered hazardous. For more information, see document no. 8015532.

Residual ripple	≤ 0.28 V _{pp}
Dielectric strength	500 V DC, 0 V against housing
Over voltage protection	≤ 36 V DC
MTTFd: mean time to dangerous failure	123 years ¹⁾

¹⁾ This product is a standard product and does not constitute a safety component as defined in the Machinery Directive. Calculation based on nominal load of components, average ambient temperature 40 °C, frequency of use 8760 h/a. All electronic failures are considered hazardous. For more information, see document no. 8015532.

Mechanical data

Mechanical design	DAX® Low Profile
Material	
Housing	Aluminum (anodised), zinc, stainless steel, brass

Ambient data

EMC	According to EN 61000-6-2 and EN 61000-6-4
Enclosure rating	IP65 / IP67 ¹⁾
Temperature	
Operating temperature range	-40 °C ... +85 °C
Storage temperature range	-40 °C ... +85 °C
Permissible relative humidity	90 % (Condensation not permitted)
Resistance to shocks	100 g, 6 ms (IEC 60068-2-27)
Resistance to vibration	8 g / 10...2,000 Hz according to IEC 60068-2-6 ²⁾

¹⁾ In correctly assembled mating connector.

²⁾ Resonance frequencies can influence signal quality.

General notes

Items supplied	Mounting brackets and position magnet enclosed. Mounting material for base not included.
-----------------------	--

Classifications

eCl@ss 5.0	27270705
eCl@ss 5.1.4	27270705
eCl@ss 6.0	27270705
eCl@ss 6.2	27270705
eCl@ss 7.0	27270705
eCl@ss 8.0	27270705
eCl@ss 8.1	27270705
eCl@ss 9.0	27270705
eCl@ss 10.0	27270705
eCl@ss 11.0	27270705
eCl@ss 12.0	27274304
ETIM 5.0	EC002544
ETIM 6.0	EC002544
ETIM 7.0	EC002544
ETIM 8.0	EC002544

UNSPSC 16.0901

41111613

Dimensional drawing (Dimensions in mm (inch))

DAX® Low Profile

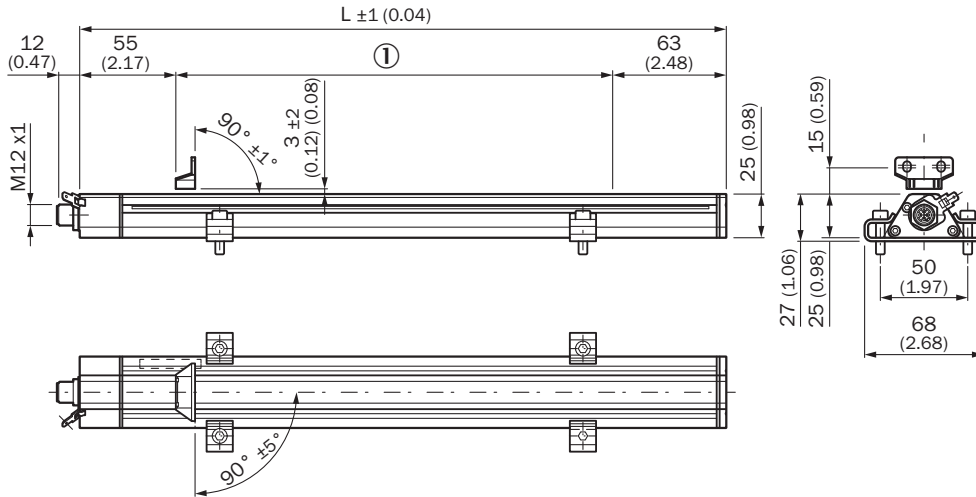

① Measuring range

Distance tolerance

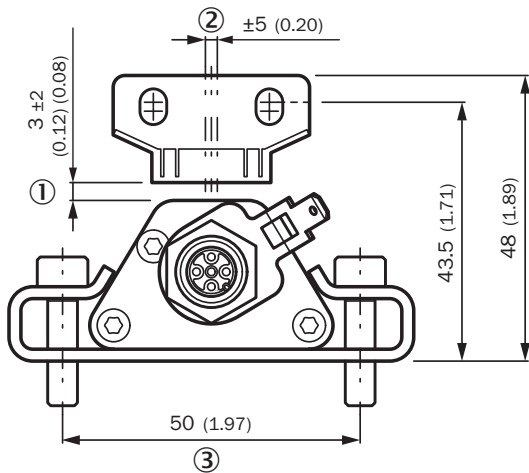

① Nominal distance + permissible amount of distance tolerance

② Permissible center offset

③ Recommendation: M5 x 20

Positioning of mounting bracket

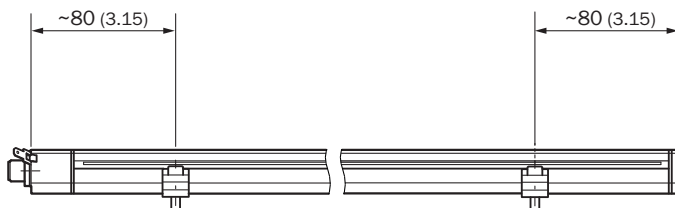

Block magnet

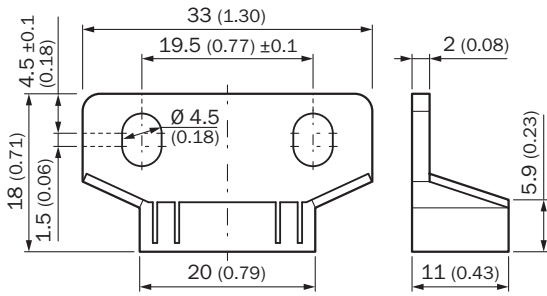

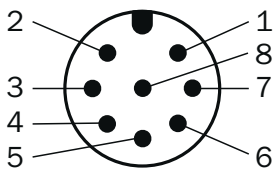

PIN assignment





M12 male connector, 8-pin	Signal
1	Output signal ground (0 V PIN 3)
2	Output signal ground (0 V PIN 5)
3	Signal 2
4	n.c.
5	Signal 1
6	Power Ground
7	+24 V DC
8	n.c.

Recommended accessories

Other models and accessories → www.sick.com/DAX

	Brief description	Type	Part no.
Magnets			
	Compact block magnet for magnetostrictive linear encoders	MAG-B-180-01	2129171
Plug connectors and cables			
	Head A: cable Head B: Flying leads Cable: SSI, Incremental, HIPERFACE®, PUR, halogen-free, shielded	LTG-2308-MWENC	6027529
	Head A: cable Head B: Flying leads Cable: SSI, TTL, HTL, Incremental, PUR, halogen-free, shielded	LTG-2612-MW	6028516

	Brief description	Type	Part no.
	Head A: female connector, M12, 8-pin, straight Head B: Flying leads Cable: Incremental, SSI, PUR, halogen-free, shielded, 2 m	DOL-1208-G02MAC1	6032866
	Head A: female connector, M12, 8-pin, straight Head B: Flying leads Cable: Incremental, SSI, PUR, halogen-free, shielded, 5 m	DOL-1208-G05MAC1	6032867
	Head A: female connector, M12, 8-pin, straight Head B: Flying leads Cable: Incremental, SSI, PUR, halogen-free, shielded, 10 m	DOL-1208-G10MAC1	6032868
	Head A: female connector, M12, 8-pin, straight Head B: Flying leads Cable: Incremental, SSI, PUR, halogen-free, shielded, 20 m	DOL-1208-G20MAC1	6032869
	Head A: female connector, M12, 8-pin, straight Head B: Flying leads Cable: Incremental, SSI, PUR, halogen-free, shielded, 25 m	DOL-1208-G25MAC1	6067859
	Head A: female connector, M12, 8-pin, straight, A-coded Cable: Incremental, SSI, shielded	DOS-1208-GA01	6045001
Terminal and alignment brackets			
	Replacement clamping bracket for DAX® Low Profile without fastening material, 2 pieces	BEF-KH-LP1-02	2125244
	Replacement clamping bracket for DAX® Low Profile without fastening material, 3 pieces	BEF-KH-LP1-03	2125245
	Replacement clamping bracket for DAX® Low Profile without fastening material, 4 pieces	BEF-KH-LP1-04	2125246

SICK AT A GLANCE

SICK is one of the leading manufacturers of intelligent sensors and sensor solutions for industrial applications. A unique range of products and services creates the perfect basis for controlling processes securely and efficiently, protecting individuals from accidents and preventing damage to the environment.

We have extensive experience in a wide range of industries and understand their processes and requirements. With intelligent sensors, we can deliver exactly what our customers need. In application centers in Europe, Asia and North America, system solutions are tested and optimized in accordance with customer specifications. All this makes us a reliable supplier and development partner.

Comprehensive services complete our offering: SICK LifeTime Services provide support throughout the machine life cycle and ensure safety and productivity.

For us, that is “Sensor Intelligence.”

WORLDWIDE PRESENCE:

Contacts and other locations –www.sick.com