



WLD4FP-32162130A00

W4F

MINIATURE PHOTOELECTRIC SENSORS

SICK
Sensor Intelligence.



Illustration may differ

Ordering information

Type	Part no.
WLD4FP-32162130A00	1113194

Other models and accessories → www.sick.com/W4F



Detailed technical data

Features

Functional principle	Photoelectric retro-reflective sensor
Functional principle detail	With minimum distance to reflector (dual lens system)
Sensing range	
Sensing range min.	0 m
Sensing range max.	4.5 m
Maximum distance range from reflector to sensor (operating reserve 1)	0.015 m ... 4.5 m
Recommended distance range from reflector to sensor (operating reserve 3,75)	0.035 m ... 3.9 m
Reference reflector	Reflector P250
Recommended sensing range for the best performance	0.035 m ... 3.9 m
Polarisation filters	Yes
Emitted beam	
Light source	PinPoint LED
Type of light	Visible red light
Shape of light spot	Point-shaped
Light spot size (distance)	Ø 38 mm (1,000 mm)

Maximum dispersion of the emitted beam around the standardized transmission axis (squint angle)	< +/- 1.5° (at T _a = +23 °C)
Key LED figures	
Normative reference	EN 62471:2008-09 IEC 62471:2006, modified
LED risk group marking	Free group
Wave length	635 nm
Average service life	100,000 h at T _a = +25 °C
Adjustment	
Teach-in button	BluePilot: for sensitivity adjustment
IO-Link	For configuring the sensor parameters and Smart Task functions
Indication	
LED blue	BluePilot: Alignment aid
LED green	Operating indicator Static on: power on Flashing: IO-Link mode
LED yellow	Status of received light beam Static on: object not present Static off: object present Flashing: Below the 1.5 function reserve

Safety-related parameters

MTTF_D	747 years
DC_{avg}	0 %
T_M (mission time)	20 years (EN ISO 13849) Rate of use: 60 %

Communication interface

IO-Link	✓, IO-Link V1.1
Data transmission rate	COM2 (38,4 kBaud)
Cycle time	2.3 ms
Process data length	16 Bit
Process data structure	Bit 0 = switching signal Q _{L1} Bit 1 = switching signal Q _{L2} Bit 2 ... 15 = Current receiver level (live)
VendorID	26
DeviceID HEX	0x800250
DeviceID DEC	8389200
Compatible master port type	A
SIO mode support	Yes

Electrical data

Supply voltage U_B	10 V DC ... 30 V DC ¹⁾
Ripple	≤ 5 V _{pp}
Usage category	DC-12 (According to EN 60947-5-2) DC-13 (According to EN 60947-5-2)

¹⁾ Limit values.

²⁾ Signal transit time with resistive load in switching mode.

³⁾ With light/dark ratio 1:1.

Current consumption	≤ 20 mA, without load. At $U_B = 24\text{ V}$
Protection class	III
Digital output	
Number	2 (Complementary)
Type	Push-pull: PNP/NPN
Signal voltage PNP HIGH/LOW	Approx. $U_B - 2.5\text{ V} / 0\text{ V}$
Signal voltage NPN HIGH/LOW	Approx. $U_B / < 2.5\text{ V}$
Output current I_{max}	≤ 100 mA
Circuit protection outputs	Reverse polarity protected Overcurrent protected Short-circuit protected
Response time	≤ 500 μs
Repeatability (response time)	150 μs ²⁾
Switching frequency	1,000 Hz ³⁾
Pin/Wire assignment	
Function of pin 4/black (BK)	Digital output, light switching, object present → output Q_{L1} LOW; IO-Link communication C
Function of pin 4/black (BK) – detail	The pin 4 function of the sensor can be configured, Additional possible settings via IO-Link
Function of pin 2/white (WH)	Digital output, dark switching, object present → output \bar{Q}_{L1} HIGH
Function of pin 2/white (WH) – detail	The pin 2 function of the sensor can be configured, Additional possible settings via IO-Link

¹⁾ Limit values.

²⁾ Signal transit time with resistive load in switching mode.

³⁾ With light/dark ratio 1:1.

Mechanical data

Housing	Rectangular
Dimensions (W x H x D)	16 mm x 40.1 mm x 12.1 mm
Connection	Cable with M8 male connector, 4-pin, 110 mm
Connection detail	
Deep-freeze property	Do not bend below 0 °C
Conductor size	0.14 mm ²
Cable diameter	∅ 3.4 mm
Length of cable (L)	77 mm
Material	
Housing	Plastic, VISTAL®
Front screen	Plastic, PMMA
Cable	PVC
Male connector	Plastic, VISTAL®
Weight	Approx. 30 g
Maximum tightening torque of the fixing screws	0.4 Nm

Ambient data

Enclosure rating	IP66 (EN 60529) IP67 (EN 60529)
Ambient operating temperature	-40 °C ... +60 °C

Ambient temperature, storage	-40 °C ... +75 °C
Typ. Ambient light immunity	Artificial light: ≤ 50,000 lx Sunlight: ≤ 50,000 lx
Shock resistance	30 g, 11 ms (3 positive and 3 negative shocks along X, Y, Z axes, 18 total shocks (EN60068-2-27))
Vibration resistance	10 Hz ... 1,000 Hz (Amplitude 1 mm, 3 x 30 min (EN60068-2-6))
Air humidity	35 % ... 95 %, Relative humidity (no condensation)
Electromagnetic compatibility (EMC)	EN 60947-5-2
Resistance to cleaning agent	ECOLAB
UL File No.	NRKH.E181493 & NRKH7.E181493

Smart Task

Smart Task name	Base logics
Logic function	Direct AND OR
Timer function	Deactivated On delay Off delay ON and OFF delay Impulse (one shot)
Inverter	Yes
Switching frequency	SIO Logic: 800 Hz ¹⁾ IOL: 750 Hz ²⁾
Response time	SIO Logic: 600 μs ¹⁾ IOL: 650 μs ²⁾
Repeatability	SIO Logic: 200 μs ¹⁾ IOL: 250 μs ²⁾
Switching signal	
Switching signal Q_{L1}	Switching output
Switching signal \bar{Q}_{L1}	Switching output

¹⁾ Use of Smart Task functions without IO-Link communication (SIO mode).

²⁾ Use of Smart Task functions with IO-Link communication function.

Diagnosis

Device temperature	
Measuring range	Very cold, cold, moderate, warm, hot
Device status	Yes
Detailed device status	Yes
Operating hour counter	Yes
Operating hours counter with reset function	Yes
Quality of teach	Yes
Quality of run	Yes, Contamination display

Classifications

eCl@ss 5.0	27270902
eCl@ss 5.1.4	27270902

eCl@ss 6.0	27270902
eCl@ss 6.2	27270902
eCl@ss 7.0	27270902
eCl@ss 8.0	27270902
eCl@ss 8.1	27270902
eCl@ss 9.0	27270902
eCl@ss 10.0	27270902
eCl@ss 11.0	27270902
eCl@ss 12.0	27270904
ETIM 5.0	EC002717
ETIM 6.0	EC002717
ETIM 7.0	EC002717
ETIM 8.0	EC002717
UNSPSC 16.0901	39121528

Connection type

Male connector M8, 4-pin

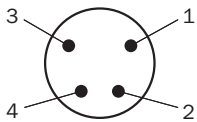

Connection diagram

Cd-490

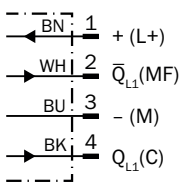

Truth table

Push-pull: PNP/NPN - light switching Q

	Light switching Q (normally closed (upper switch), normally open (lower switch))	
	Object not present → Output HIGH	Object present → Output LOW
Light receive	✓	✗
Light receive indicator	☉	✗
Load resistance to L+	✗	⚠
Load resistance to M	⚠	✗

Push-pull: PNP/NPN – dark switching \bar{Q}

	Dark switching \bar{Q} (normally open (upper switch), normally closed (lower switch))	
	Object not present → Output LOW	Object present → Output HIGH
Light receive	✓	✗
Light receive indicator	☉	✗
Load resistance to L+	⚠	✗
Load resistance to M	✗	⚠

Characteristic curve

Reflective tape

Operating reserve

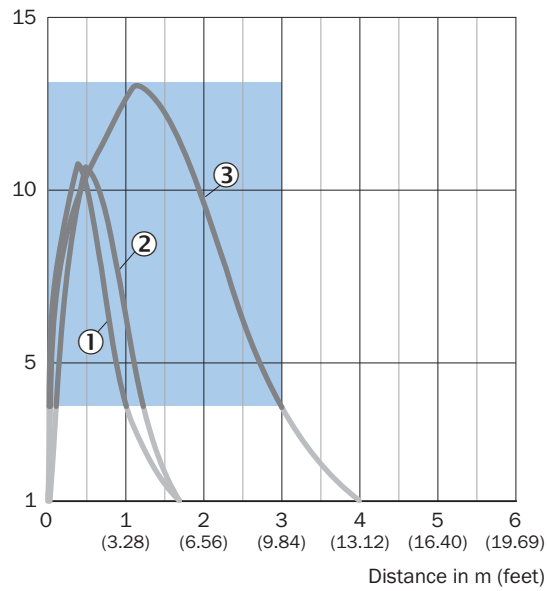

Recommended sensing range for the best performance

- ① Reflective tape REF-DG
- ② Reflective tape REF-IRF-56
- ③ Reflective tape REF-AC1000

Standard reflectors

Operating reserve

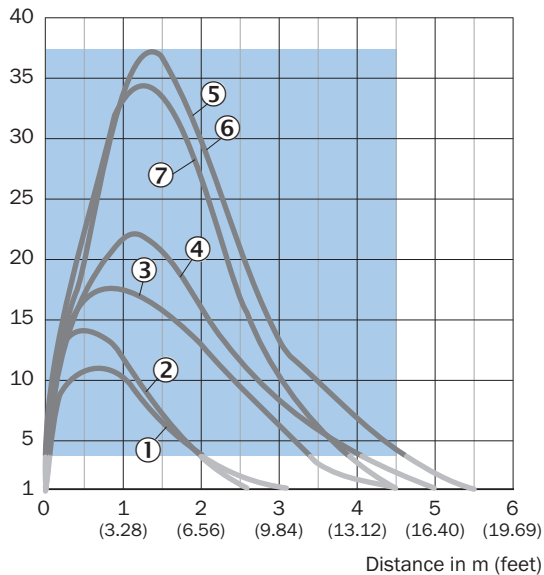

Recommended sensing range for the best performance

- ① Reflector PL22
- ② Reflector PL20A
- ③ Reflector PL30A
- ④ Reflector PL40A
- ⑤ Reflector PL80A
- ⑥ Reflector C110A
- ⑦ Reflector P250

Fine triple reflectors

Operating reserve

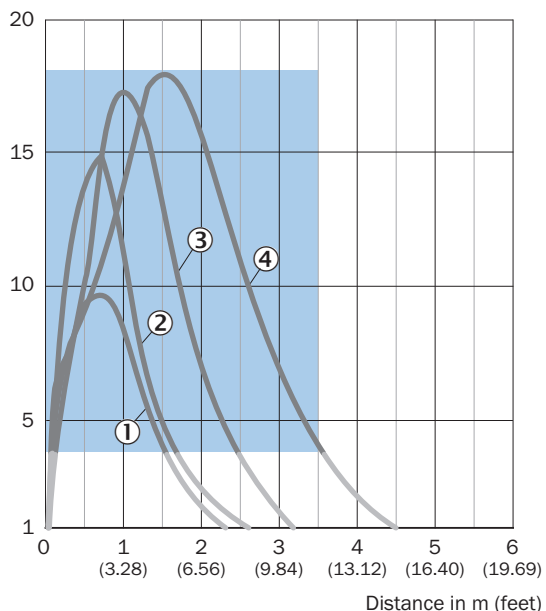

- Recommended sensing range for the best performance
- ① PL10FH reflector
- ② PL10F reflector
- ③ Reflector PL20F
- ④ Reflector P250F

Chemical-resistant reflectors

Operating reserve

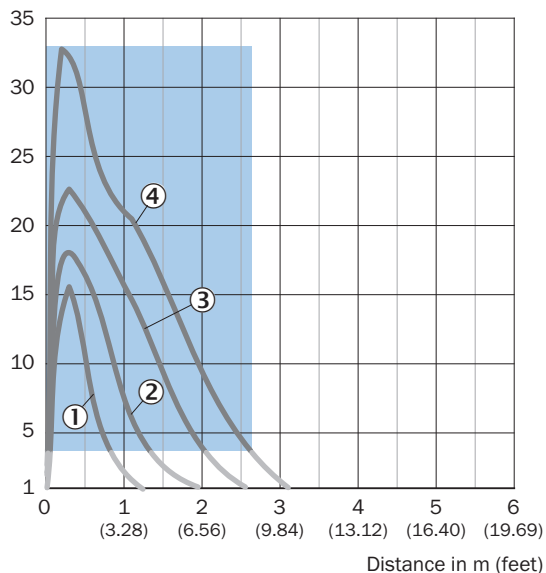

- Recommended sensing range for the best performance
- ① PL10F CHEM reflector
- ② Reflector PL20 CHEM
- ③ Reflector P250 CHEM
- ④ Reflector P250H

Light spot size

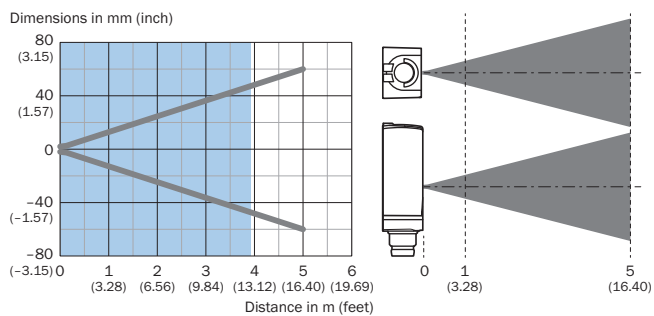

Recommended sensing range for the best performance

Sensing range diagram

Standard reflectors

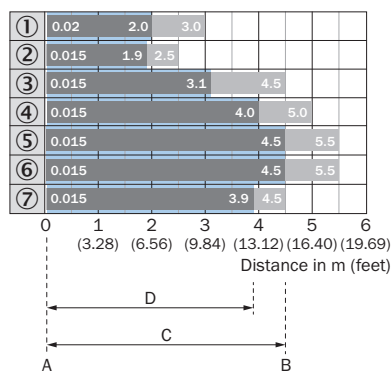

A = Sensing range min. in m
 B = Sensing range max. in m
 C = Maximum distance range from reflector to sensor (operating reserve 1)
 D = Recommended distance range from reflector to sensor (operating reserve 3.75)

Recommended sensing range for the best performance

- ① Reflector PL22
- ② Reflector PL20A
- ③ Reflector PL30A
- ④ Reflector PL40A
- ⑤ Reflector PL80A
- ⑥ Reflector C110A
- ⑦ Reflector P250

Reflective tape

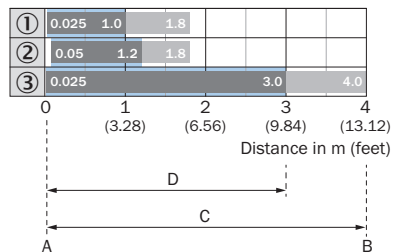

A = Sensing range min. in m
 B = Sensing range max. in m
 C = Maximum distance range from reflector to sensor (operating reserve 1)
 D = Recommended distance range from reflector to sensor (operating reserve 3.75)

Recommended sensing range for the best performance

- ① Reflective tape REF-DG (50 x 50 mm)
- ② Reflective tape REF-IRF-56
- ③ Reflective tape REF-AC1000

Fine triple reflectors

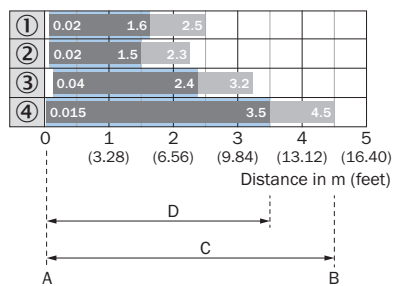

A = Sensing range min. in m
 B = Sensing range max. in m
 C = Maximum distance range from reflector to sensor (operating reserve 1)
 D = Recommended distance range from reflector to sensor (operating reserve 3.75)

Recommended sensing range for the best performance

- ① PL10FH reflector
- ② PL10F reflector
- ③ Reflector PL20F
- ④ Reflector P250F

Chemical-resistant reflectors

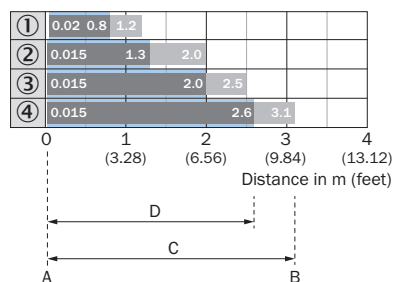

A = Sensing range min. in m
 B = Sensing range max. in m
 C = Maximum distance range from reflector to sensor (operating reserve 1)
 D = Recommended distance range from reflector to sensor (operating reserve 3.75)

Recommended sensing range for the best performance

- ① PL10F CHEM reflector
- ② Reflector PL20 CHEM
- ③ Reflector P250 CHEM
- ④ Reflector P250H

Adjustments

Display and adjustment elements

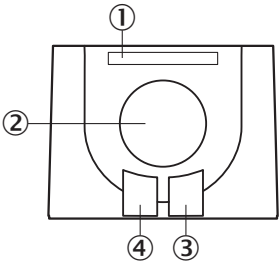

- ① LED blue
- ② Teach-in button
- ③ LED yellow
- ④ LED green

Dimensional drawing (Dimensions in mm (inch))

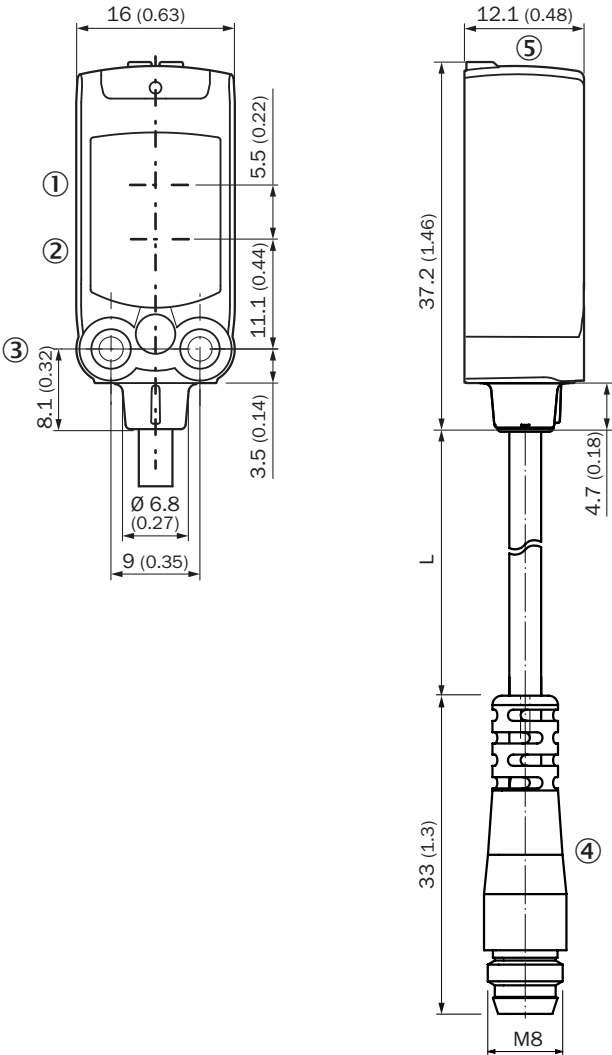





For length of cable (L), see technical data

- ① Center of optical axis, sender
- ② Center of optical axis, receiver
- ③ M3 mounting hole
- ④ Cable with connector M8
- ⑤ Display and adjustment elements

Recommended accessories

Other models and accessories → www.sick.com/W4F

	Brief description	Type	Part no.
Mounting brackets and plates			
	Mounting bracket for wall mounting, Stainless steel 1.4571, mounting hardware included	BEF-W4-A	2051628
Plug connectors and cables			
	Head A: female connector, M12, 4-pin, straight, A-coded Head B: Flying leads Cable: Sensor/actuator cable, PVC, unshielded, 5 m	YF2A14-050VB3XLEAX	2096235
	Head A: male connector, M8, 4-pin, straight Cable: unshielded	STE-0804-G	6037323
	Head A: male connector, M12, 4-pin, straight Cable: unshielded	STE-1204-G	6009932
Reflectors			
	Fine triple reflector, screw connection, suitable for laser sensors, 20 mm x 32 mm, PM-MA/ABS, Screw-on, 2 hole mounting	PL10F	5311210

SICK AT A GLANCE

SICK is one of the leading manufacturers of intelligent sensors and sensor solutions for industrial applications. A unique range of products and services creates the perfect basis for controlling processes securely and efficiently, protecting individuals from accidents and preventing damage to the environment.

We have extensive experience in a wide range of industries and understand their processes and requirements. With intelligent sensors, we can deliver exactly what our customers need. In application centers in Europe, Asia and North America, system solutions are tested and optimized in accordance with customer specifications. All this makes us a reliable supplier and development partner.

Comprehensive services complete our offering: SICK LifeTime Services provide support throughout the machine life cycle and ensure safety and productivity.

For us, that is “Sensor Intelligence.”

WORLDWIDE PRESENCE:

Contacts and other locations –www.sick.com