



# C4C-EB03010A10000

deTec

**SAFETY LIGHT CURTAINS**

**SICK**  
Sensor Intelligence.



Illustration may differ

### Ordering information

deTec4 Core IP69K

Note	Resolution	Scanning range	Protective field height	System part	Type	Part no.
Completely pre-installed including connecting cable, 15 m, flying lead, 5-wire	14 mm	8.5 m	300 mm	Receiver	C4C-EB03010A1000	1219058

Completely pre-installed including connecting cable, 15 m, flying lead, 5-wire

Other models and accessories → [www.sick.com/deTec](http://www.sick.com/deTec)



### Detailed technical data

#### Features

<b>Sub product family</b>	deTec4 Core IP69K
<b>Application</b>	Areas with special hygiene requirements
<b>System part</b>	Receiver
<b>Compatible sender</b>	1219531
<b>Resolution</b>	14 mm
<b>Scanning range</b>	8.5 m
<b>Protective field height</b>	300 mm
<b>Response time</b>	11 ms
<b>No blind zones</b>	Yes
<b>Synchronization</b>	Optical synchronisation
<b>Items supplied</b>	Receiver in IP69K protective housing with connecting cable, 15 m Test rod with diameter corresponding to the resolution of the safety light curtain Safety instruction Mounting instructions Operating instructions for download

#### Safety-related parameters

<b>Type</b>	Type 4 (IEC 61496-1)
<b>Safety integrity level</b>	SIL3 (IEC 61508)
<b>Category</b>	Category 4 (ISO 13849-1)
<b>Performance level</b>	PL e (ISO 13849-1)

<b>PFH<sub>D</sub> (mean probability of a dangerous failure per hour)</b>	3.7 x 10 <sup>-9</sup>
<b>T<sub>M</sub> (mission time)</b>	20 years (ISO 13849-1)
<b>Safe state in the event of a fault</b>	At least one OSSD is in the OFF state.

### Functions

<b>Protective operation</b>	✓
<b>Automatic calibration of the protective field width</b>	✓

### Interfaces

<b>System connection</b>	Connecting cable, 15 m, flying leads, 5-wire
Length of cable	15 m
Cable diameter	5 mm
Cable material	PUR, halogen-free
Conductor cross section	0.34 mm <sup>2</sup>
<b>Display elements</b>	LEDs

### Electrical data

<b>Protection class</b>	III (IEC 61140)
<b>Supply voltage V<sub>S</sub></b>	24 V DC (19.2 V ... 28.8 V)
<b>Ripple</b>	≤ 10 %
<b>Power consumption typical</b>	1.92 W (DC)
<b>Output signal switching devices (OSSDs)</b>	
Type of output	2 PNP semiconductors, short-circuit protected, cross-circuit monitored <sup>1)</sup>
ON state, switching voltage HIGH	24 V DC (V <sub>S</sub> - 2.25 V DC ... V <sub>S</sub> )
OFF state, switching voltage LOW	≤ 2 V DC
Current-carrying capacity per OSSD	≤ 300 mA

<sup>1)</sup> Applies to the voltage range between -30 V and +30 V.

### Mechanical data

<b>Dimensions</b>	See dimensional drawing
<b>Material</b>	
Protective housing	Acrylic glass (PMMA)
End caps	Stainless steel 1.4404
Cable glands	Stainless steel 1.4404 including silicone seal
Compensating element (membrane)	PA 6

### Ambient data

<b>Enclosure rating</b>	IP65 (IEC 60529) IP66 (IEC 60529) IP67 (IEC 60529) IP69K (ISO 20653)
<b>Ambient operating temperature</b>	-30 °C ... +55 °C
<b>Storage temperature</b>	-30 °C ... +70 °C
<b>Air humidity</b>	15 % ... 95 %, Non-condensing
<b>Vibration resistance</b>	5 g, 10 Hz ... 55 Hz (IEC 60068-2-6)

<b>Shock resistance</b>	10 g, 16 ms (IEC 60068-2-27)
-------------------------	------------------------------

## Classifications

<b>eCl@ss 5.0</b>	27272704
<b>eCl@ss 5.1.4</b>	27272704
<b>eCl@ss 6.0</b>	27272704
<b>eCl@ss 6.2</b>	27272704
<b>eCl@ss 7.0</b>	27272704
<b>eCl@ss 8.0</b>	27272704
<b>eCl@ss 8.1</b>	27272704
<b>eCl@ss 9.0</b>	27272704
<b>eCl@ss 10.0</b>	27272704
<b>eCl@ss 11.0</b>	27272704
<b>eCl@ss 12.0</b>	27272704
<b>ETIM 5.0</b>	EC002549
<b>ETIM 6.0</b>	EC002549
<b>ETIM 7.0</b>	EC002549
<b>ETIM 8.0</b>	EC002549
<b>UNSPSC 16.0901</b>	46171620

Dimensional drawing (Dimensions in mm (inch))

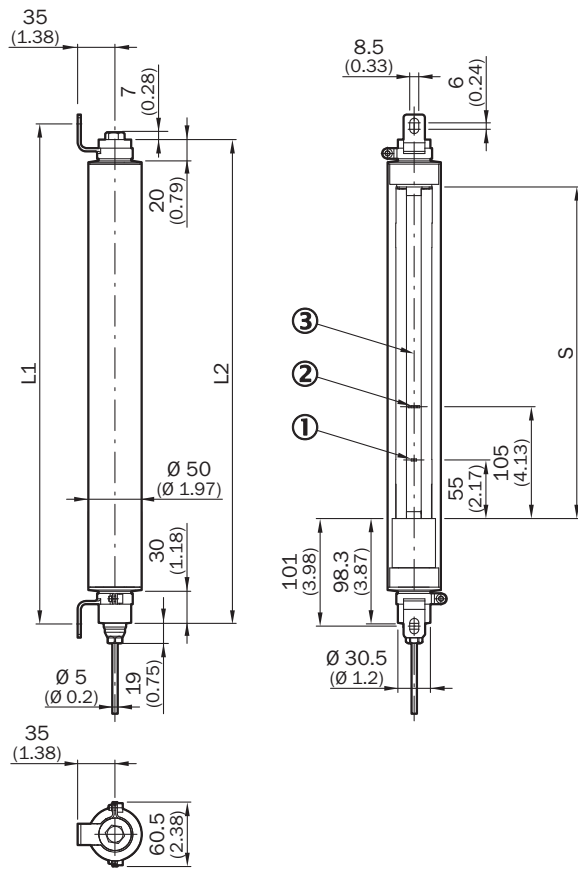

- ① Operating indicator
- ② Alignment indicator
- ③ Optical axis

	S	L1	L2
300	311	469	454
450	461	619	604
600	611	769	754
750	761	919	904
900	911	1,069	1,054
1,050	1,061	1,219	1,204
1,200	1,211	1,369	1,354
1,350	1,361	1,519	1,504
1,500	1,511	1,669	1,654
1,650	1,661	1,819	1,804
1,800	1,811	1,969	1,954

### Connection diagram

DeTec4 Core IP69K safety light curtain to RLY3-OSSD2 safety relay

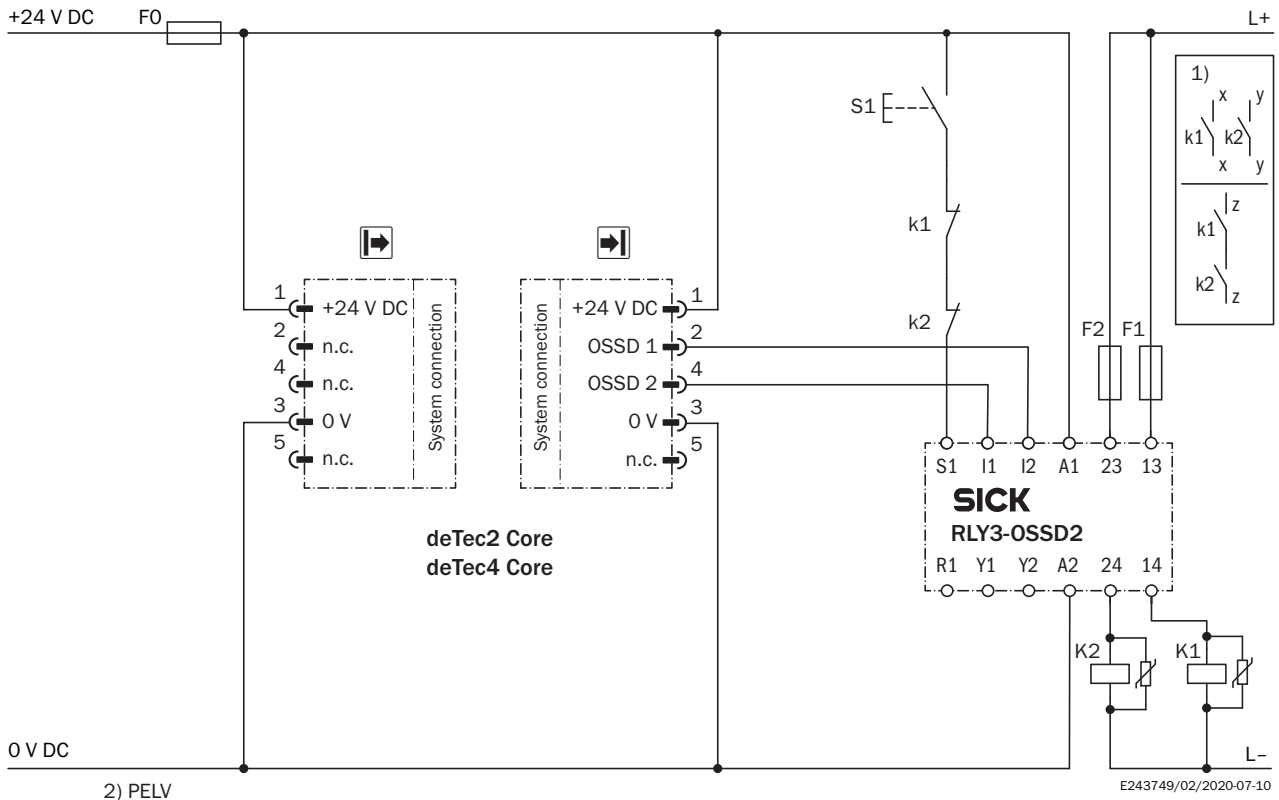

#### Task

Connection of a deTec4 Core IP69K or deTec2 Core IP69K safety light curtain to RLY3-OSSD2. Operating mode: with restart interlock and external device monitoring.

#### Function

When the protective field is clear, the OSSD1 and OSSD2 outputs carry voltage. The system can be switched on when K1 and K2 are in a fault-free de-energized position. The RLY3-OSSD2 is switched on by pressing S1 (pushbutton is pressed and released). The outputs (contacts 13-14 and 23-24) switch the K1 and K2 contactors on. When the protective field is interrupted, the OSSD1 and OSSD2 outputs switch the RLY3-OSSD2 off. Contactors K1 and K2 are switched off.

#### Fault analysis

Cross-circuits and short-circuits of the OSSDs are recognized and lead to the locking status (lock-out). A malfunction with one of the K1 or K2 contactors is detected. The switch-off function is retained. In the event of manipulation (e.g., jamming) of the S1 pushbutton, the RLY3-OSSD2 will not re-enable the output current circuits.

#### Comments

<sup>1)</sup> Output circuits: These contacts must be incorporated into the control such that the dangerous state is brought to an end if the output circuit is open. For categories 4 and 3, they must be incorporated on dual-channels (x, y paths). Type 2 devices are suitable for use up to PL c. Single-channel incorporation into the control (z path) is only possible with a singlechannel control and taking the risk analysis into account.





<sup>2)</sup> SELV/PELV safety extra-low voltage.

Con- nec- or-cod- tion	Col- or-cod- ed con- nect- ing cable	Sender	Receiver
1	Brown	+24 V DC	+24 V DC
2	White	Reserved	OSSD 1
3	Blue	0 V DC	0 V DC

Con- nec- tion	Col- or-cod- ed con- nect- ing cable	Sender	Receiver
4	Black	Reserved	OSSD 2
5	Gray	-	-

## Recommended accessories

Other models and accessories → [www.sick.com/deTec](http://www.sick.com/deTec)

	Brief description	Type	Part no.
Terminal and alignment brackets			
	2 pieces, Stainless steel support bracket, stainless steel 1.4350	BEF-2AAAADES2	2026849
	4 pieces, Stainless steel bracket, rotatable, stainless steel 1.4350, stainless steel 1.4301	BEF-2SMMEAES4	2023708
	4 pieces, Reinforced stainless steel bracket, rotatable, stainless steel 1.4350, stainless steel 1.4301	BEF-2SMMVAES4	2026850
Safety switching amplifier			
	<ul style="list-style-type: none"> <li>• <b>Applications:</b> Evaluation unit</li> <li>• <b>Compatible sensor types:</b> Safety sensors with OSSDs</li> <li>• <b>Connection type:</b> Front connector with spring terminals</li> <li>• <b>Restart interlock:</b> yes</li> <li>• <b>External device monitoring (EDM):</b> Integrated</li> <li>• <b>Outputs:</b> 2 enabling current paths (safe), 2 application diagnostic outputs (not safe), 1 test pulse output (not safe)</li> <li>• <b>Housing width:</b> 18 mm</li> </ul>	RLY3-OSSD200	1085344
	<ul style="list-style-type: none"> <li>• <b>Applications:</b> Evaluation unit</li> <li>• <b>Compatible sensor types:</b> Safety sensors with OSSDs</li> <li>• <b>Connection type:</b> Front connector with spring terminals</li> <li>• <b>Restart interlock:</b> yes</li> <li>• <b>External device monitoring (EDM):</b> Integrated</li> <li>• <b>Outputs:</b> 3 enabling current paths (safe), 2 application diagnostic outputs (not safe), 1 test pulse output (not safe)</li> <li>• <b>Housing width:</b> 18 mm</li> </ul>	RLY3-OSSD300	1099969

## SICK AT A GLANCE

SICK is one of the leading manufacturers of intelligent sensors and sensor solutions for industrial applications. A unique range of products and services creates the perfect basis for controlling processes securely and efficiently, protecting individuals from accidents and preventing damage to the environment.

We have extensive experience in a wide range of industries and understand their processes and requirements. With intelligent sensors, we can deliver exactly what our customers need. In application centers in Europe, Asia and North America, system solutions are tested and optimized in accordance with customer specifications. All this makes us a reliable supplier and development partner.

Comprehensive services complete our offering: SICK LifeTime Services provide support throughout the machine life cycle and ensure safety and productivity.

For us, that is “Sensor Intelligence.”

## WORLDWIDE PRESENCE:

Contacts and other locations –[www.sick.com](http://www.sick.com)