



# GTB2F-P5141

G2F

MINIATURE PHOTOELECTRIC SENSORS

**SICK**  
Sensor Intelligence.



Illustration may differ



## Ordering information

Type	Part no.
GTB2F-P5141	1093729

Other models and accessories → [www.sick.com/G2F](http://www.sick.com/G2F)

## Detailed technical data

### Features

<b>Sensor/ detection principle</b>	Photoelectric proximity sensor, Background suppression
<b>Dimensions (W x H x D)</b>	14 mm x 24 mm x 3.5 mm
<b>Housing design (light emission)</b>	Rectangular
<b>Minimum detectable object (MDO)</b>	0.1 mm <sup>1)</sup>
<b>Sensing range max.</b>	1 mm ... 9 mm
<b>Sensing range</b>	1 mm ... 8 mm <sup>2)</sup>
<b>Type of light</b>	Visible red light
<b>Light source</b>	PinPoint LED <sup>3)</sup>
<b>Light spot size (distance)</b>	Ø 1 mm (5 mm)
<b>Wave length</b>	660 nm
<b>Adjustment</b>	None

<sup>1)</sup> In 5 mm distance.

<sup>2)</sup> Object with 90 % reflectance (referred to standard white, DIN 5033).

<sup>3)</sup> Average service life: 100,000 h at T<sub>J</sub> = +25 °C.

### Mechanics/electronics

<b>Supply voltage</b>	10 V DC ... 30 V DC
<b>Ripple</b>	< 5 V <sub>pp</sub> <sup>1)</sup>

<sup>1)</sup> May not exceed or fall below U<sub>v</sub> tolerances.

<sup>2)</sup> Without load.

<sup>3)</sup> Signal transit time with resistive load.

<sup>4)</sup> With light/dark ratio 1:1.

<sup>5)</sup> Do not bend below 0 °C.

<sup>6)</sup> A = V<sub>S</sub> connections reverse-polarity protected.

<sup>7)</sup> C = interference suppression.

<sup>8)</sup> D = outputs overcurrent and short-circuit protected.

<b>Current consumption</b>	20 mA <sup>2)</sup>
<b>Switching output</b>	PNP
<b>Switching mode</b>	Light switching
<b>Output current I<sub>max.</sub></b>	≤ 50 mA
<b>Response time</b>	< 0.625 ms <sup>3)</sup>
<b>Switching frequency</b>	800 Hz <sup>4)</sup>
<b>Connection type</b>	Cable with connector M8, 3-pin, 200 mm <sup>5)</sup>
<b>Cable material</b>	PVC
<b>Cable diameter</b>	Ø 2.3 mm
<b>Circuit protection</b>	A <sup>6)</sup> C <sup>7)</sup> D <sup>8)</sup>
<b>Weight</b>	13 g
<b>Housing material</b>	Plastic, VISTAL®
<b>Optics material</b>	Plastic, MABS
<b>Enclosure rating</b>	IP67
<b>Ambient operating temperature</b>	-20 °C ... +50 °C
<b>Ambient temperature, storage</b>	-40 °C ... +70 °C
<b>UL File No.</b>	NRKH.E348498 & NRKH7.E348498
<b>Repeatability (T<sub>a</sub> not constant)</b>	0.1 mm
<b>Hysteresis</b>	< 0.3 mm

<sup>1)</sup> May not exceed or fall below U<sub>v</sub> tolerances.

<sup>2)</sup> Without load.

<sup>3)</sup> Signal transit time with resistive load.

<sup>4)</sup> With light/dark ratio 1:1.

<sup>5)</sup> Do not bend below 0 °C.

<sup>6)</sup> A = V<sub>S</sub> connections reverse-polarity protected.

<sup>7)</sup> C = interference suppression.

<sup>8)</sup> D = outputs overcurrent and short-circuit protected.

## Classifications

<b>ECl@ss 5.0</b>	27270904
<b>ECl@ss 5.1.4</b>	27270904
<b>ECl@ss 6.0</b>	27270904
<b>ECl@ss 6.2</b>	27270904
<b>ECl@ss 7.0</b>	27270904
<b>ECl@ss 8.0</b>	27270904
<b>ECl@ss 8.1</b>	27270904
<b>ECl@ss 9.0</b>	27270904
<b>ECl@ss 10.0</b>	27270904
<b>ECl@ss 11.0</b>	27270904
<b>ETIM 5.0</b>	EC002719
<b>ETIM 6.0</b>	EC002719

<b>ETIM 7.0</b>	EC002719
<b>ETIM 8.0</b>	EC002719
<b>UNSPSC 16.0901</b>	39121528

### Connection diagram

Cd-045

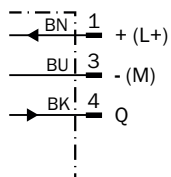

### Light spot size

GTB2 Flat, 8 mm

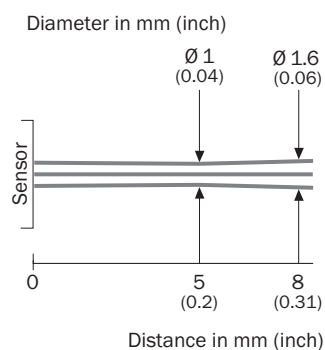

### Sensing range diagram

GTB2 Flat, 8 mm

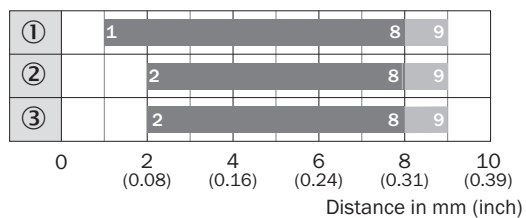

■ Sensing range      ■ Sensing range typ. max.

- ① Sensing range on white, 90 % remission
- ② Sensing range on gray, 18 % remission
- ③ Sensing range on black, 6 % remission

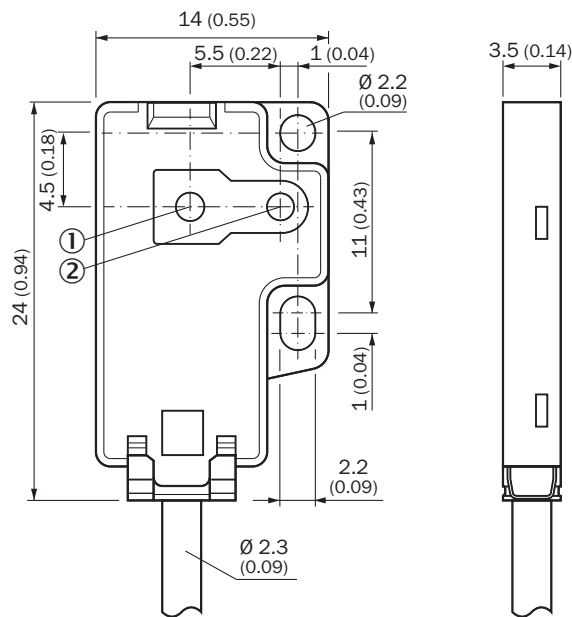

Dimensional drawing (Dimensions in mm (inch))



- ① Optical axis, receiver
- ② Optical axis, sender

Recommended accessories

Other models and accessories → [www.sick.com/G2F](http://www.sick.com/G2F)

	Brief description	Type	Part no.
<b>Mounting brackets and plates</b>			
	10 pieces, Mounting plate for direct mounting, from the rear, on wall or machine, not adjustable. 10 Piece,Black ,Plastic, VISTAL®. Suitable for GTB2F and GSE2F	BEF-G2F-FLAT-SPACER-M2	2107263
<b>Plug connectors and cables</b>			
	Head A: female connector, M8, 3-pin, straight, A-coded Head B: Flying leads Cable: Sensor/actuator cable, PVC, unshielded, 5 m	YF8U13-050VA1XLEAX	2095884
	Head A: male connector, M8, 3-pin, straight Head B: - Cable: unshielded	STE-0803-G	6037322

## SICK AT A GLANCE

SICK is one of the leading manufacturers of intelligent sensors and sensor solutions for industrial applications. A unique range of products and services creates the perfect basis for controlling processes securely and efficiently, protecting individuals from accidents and preventing damage to the environment.

We have extensive experience in a wide range of industries and understand their processes and requirements. With intelligent sensors, we can deliver exactly what our customers need. In application centers in Europe, Asia and North America, system solutions are tested and optimized in accordance with customer specifications. All this makes us a reliable supplier and development partner.

Comprehensive services complete our offering: SICK LifeTime Services provide support throughout the machine life cycle and ensure safety and productivity.

For us, that is “Sensor Intelligence.”

## WORLDWIDE PRESENCE:

Contacts and other locations –[www.sick.com](http://www.sick.com)