



PU3H22-000000000

Device columns with external grooves

COLUMNS FOR SAFETY LIGHT CURTAINS

SICK
Sensor Intelligence.



Ordering information

Type	Part no.
PU3H22-0000000	2045645

Other models and accessories → www.sick.com/Device_columns_with_external_grooves

Detailed technical data

Features

Model	Device columns with two external mounting grooves
Suitable for	Safety light curtains Safety multibeam sensors
Suitable for protective field height	
C2000, C4000, M4000 Curtain	≤ 1,800 mm
deTec2, deTec4	≤ 2,100 mm
Suitable for number of beams	Any
Suitable for beam separation	Any

Mechanical data

Column height	2,270 mm
Max. installation length	2,250 mm
Dimensional drawing	
L1	2,250 mm
L2	2,270 mm
Weight	15,300 g

Classifications

eCl@ss 5.0	27279202
eCl@ss 5.1.4	27279202
eCl@ss 6.0	27279202
eCl@ss 6.2	27279202
eCl@ss 7.0	27279202
eCl@ss 8.0	27279202
eCl@ss 8.1	27279202
eCl@ss 9.0	27273701
eCl@ss 10.0	27273701
eCl@ss 11.0	27273701
eCl@ss 12.0	27273701
ETIM 5.0	EC001941

ETIM 6.0	EC001941
ETIM 7.0	EC001941
ETIM 8.0	EC001941
UNSPSC 16.0901	39111609

Dimensional drawing (Dimensions in mm (inch))

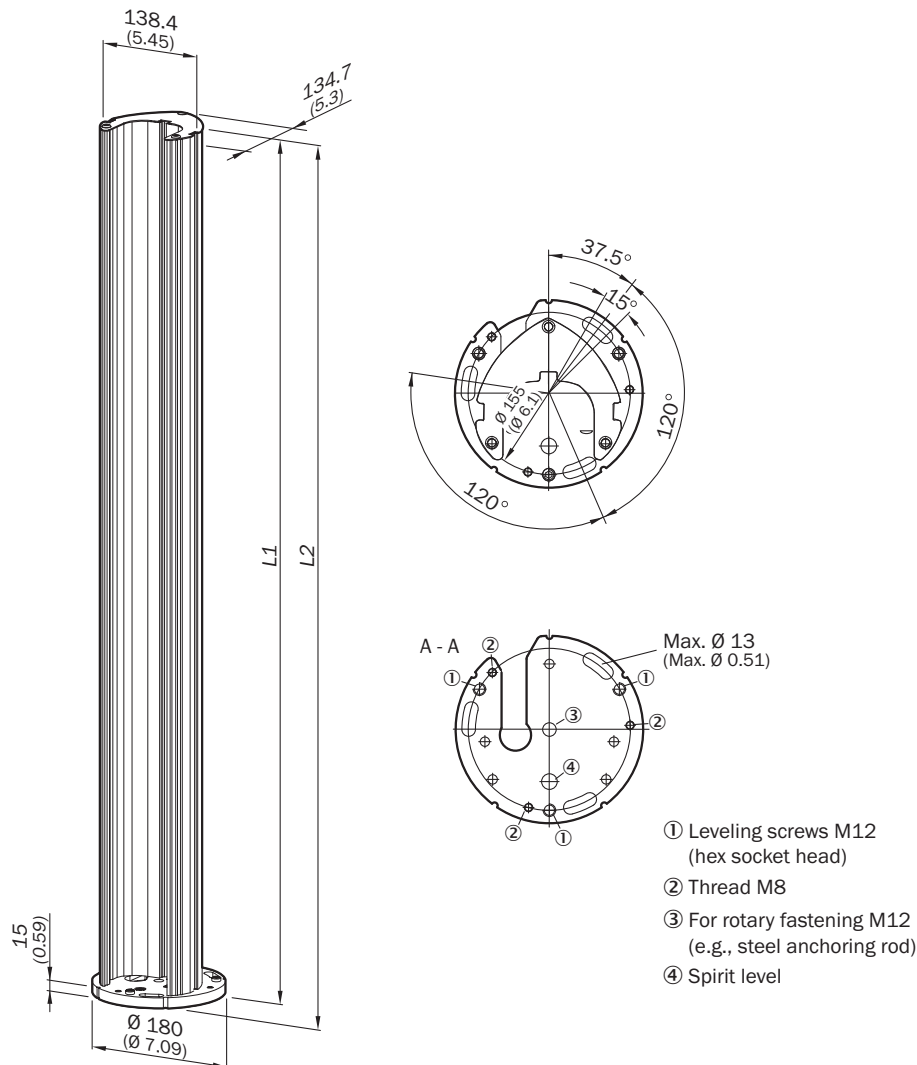

Suitable for protective field height		Suitable for number of beams	L1	L2	Part no.
C2000, C4000, M4000 Curtain	deTec2, deTec4				
≤ 600 (23.62)	≤ 900 (35.43)	2	965 (37.99)	985 (38.78)	2045490
≤ 900 (35.43)	≤ 1,050 (41.34)	3	1,165 (45.87)	1,185 (46.65)	2045641
≤ 1,050 (41.34)	≤ 1,200 (47.24)	4	1,265 (49.80)	1,285 (50.59)	2045642
≤ 1,350 (53.15)	≤ 1,500 (59.06)	Any	1,550 (61.02)	1,570 (61.81)	2068813
≤ 1,350 (53.15)	≤ 1,650 (64.96)	Any	1,720 (67.72)	1,740 (68.50)	2045643
≤ 1,650 (64.96)	≤ 1,950 (76.77)	Any	2,020 (79.53)	2,040 (80.31)	2045644

PU3H22-00000000 | Device columns with external grooves

COLUMNS FOR SAFETY LIGHT CURTAINS

Suitable for protective field height		Suitable for number of beams	L1	L2	Part no.
C2000, C4000, M4000 Curtain	deTec2, deTec4				
≤ 1,800 (70.87)	≤ 2,100 (82.68)	Any	2,250 (88.58)	2,270 (89.37)	2045645
≤ 1,800 (70.87)	≤ 2,100 (82.68)	Any	2,400 (94.49)	2,420 (95.28)	2045646

SICK AT A GLANCE

SICK is one of the leading manufacturers of intelligent sensors and sensor solutions for industrial applications. A unique range of products and services creates the perfect basis for controlling processes securely and efficiently, protecting individuals from accidents and preventing damage to the environment.

We have extensive experience in a wide range of industries and understand their processes and requirements. With intelligent sensors, we can deliver exactly what our customers need. In application centers in Europe, Asia and North America, system solutions are tested and optimized in accordance with customer specifications. All this makes us a reliable supplier and development partner.

Comprehensive services complete our offering: SICK LifeTime Services provide support throughout the machine life cycle and ensure safety and productivity.

For us, that is “Sensor Intelligence.”

WORLDWIDE PRESENCE:

Contacts and other locations –www.sick.com