



DOL-1205-W10MAC

SICK
Sensor Intelligence.



Ordering information

Type	Part no.
DOL-1205-W10MAC	6041752

Other models and accessories → www.sick.com/

Detailed technical data

Technical specifications

Accessory group	Plug connectors and cables				
Accessory family	Connecting cables				
Connection type head A	Female connector, M12, 5-pin, angled, A-coded				
Connection type head B	Flying leads				
Connector material	TPU				
Connector color	Black				
Locking nut material	Zinc die-cast, nickel-plated				
Tightening torque	0.4 Nm				
Cable	10 m, 5-wire, PUR, halogen-free				
Jacket material	PUR, halogen-free				
Jacket color	Black				
Cable diameter	5.9 mm				
Conductor cross-section	0.34 mm ²				
Shielding	Shielded				
Bending radius	<table border="0"> <tr> <td style="padding-right: 20px;">Flexible use</td> <td>> 10 x cable diameter</td> </tr> <tr> <td>Stationary position</td> <td>> 5 x cable diameter</td> </tr> </table>	Flexible use	> 10 x cable diameter	Stationary position	> 5 x cable diameter
Flexible use	> 10 x cable diameter				
Stationary position	> 5 x cable diameter				
Bending cycles	≥ 4,000,000				
Reference voltage	≤ 60 V				
Current loading	4 A				
Traversing speed	Max. 3 m/s				
Travelling distance	10 m				
Acceleration	≤ 10 m/s ²				
Signal type	HIPERFACE®				
Application	Zones with oils and lubricants Drag chain operation				
Note	Sensor/actuator cable				
Enclosure rating	IP65/ IP67				
Ambient operating temperature	<table border="0"> <tr> <td style="padding-right: 20px;">Flexible use</td> <td>-25 °C ... +80 °C</td> </tr> <tr> <td>Stationary position</td> <td>-40 °C ... +80 °C</td> </tr> </table>	Flexible use	-25 °C ... +80 °C	Stationary position	-40 °C ... +80 °C
Flexible use	-25 °C ... +80 °C				
Stationary position	-40 °C ... +80 °C				

Head -25 °C ... +90 °C

Classifications

ECI@ss 5.0	19030312
ECI@ss 5.1.4	19030312
ECI@ss 6.0	27060304
ECI@ss 6.2	27060304
ECI@ss 7.0	27060304
ECI@ss 8.0	27060304
ECI@ss 8.1	27060304
ECI@ss 9.0	27060304
ECI@ss 10.0	27060304
ECI@ss 11.0	27060304
ECI@ss 12.0	27060304
ETIM 5.0	EC000830
ETIM 6.0	EC000830
ETIM 7.0	EC003249
ETIM 8.0	EC003249
UNSPSC 16.0901	26121604

Dimensional drawing (Dimensions in mm (inch))

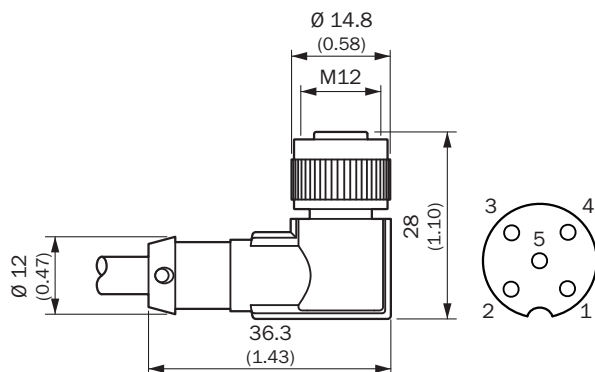

female connector M 12 x 1, angled, screened

- ① Brown
- ② White
- ③ Blue
- ④ Black
- ⑤ Gray

PIN assignment



Contact assignment of the M12 female connector

SICK AT A GLANCE

SICK is one of the leading manufacturers of intelligent sensors and sensor solutions for industrial applications. A unique range of products and services creates the perfect basis for controlling processes securely and efficiently, protecting individuals from accidents and preventing damage to the environment.

We have extensive experience in a wide range of industries and understand their processes and requirements. With intelligent sensors, we can deliver exactly what our customers need. In application centers in Europe, Asia and North America, system solutions are tested and optimized in accordance with customer specifications. All this makes us a reliable supplier and development partner.

Comprehensive services complete our offering: SICK LifeTime Services provide support throughout the machine life cycle and ensure safety and productivity.

For us, that is “Sensor Intelligence.”

WORLDWIDE PRESENCE:

Contacts and other locations –www.sick.com