



HSE18B-P4B1AA

H18 Sure Sense

HYBRID PHOTOELECTRIC SENSORS

SICK
Sensor Intelligence.



Illustration may differ



Ordering information

Type	Part no.
HSE18B-P4B1AA	1101664

Other models and accessories → www.sick.com/H18_Sure_Sense

Detailed technical data

Features

Functional principle	Through-beam photoelectric sensor
Dimensions (W x H x D)	16.2 mm x 50.1 mm x 31.4 mm
Housing design (light emission)	Hybrid
Thread diameter (housing)	M18
Mounting system type	M18, head/M18, base/side (24.1 ... 25.4 mm)
Housing color	Blue
Sensing range max.	0 m ... 20 m
Sensing range	0 m ... 15 m
Type of light	Infrared light
Light source	LED ¹⁾
Light spot size (distance)	1,400 mm (10 m)
Wave length	850 nm
Adjustment	
	Potentiometer, right None
	Potentiometer, left None
Special features	-

¹⁾ Average service life: 100,000 h at T_U = +25 °C.

Mechanics/electronics

Supply voltage	10 V DC ... 30 V DC
-----------------------	---------------------

- ¹⁾ May not exceed or fall below U_v tolerances.
- ²⁾ Without signal strength light bar and load.
- ³⁾ Signal transit time with resistive load.
- ⁴⁾ With light/dark ratio 1:1.
- ⁵⁾ A = V_S connections reverse-polarity protected.
- ⁶⁾ B = inputs and output reverse-polarity protected.
- ⁷⁾ D = outputs overcurrent and short-circuit protected.

Ripple	< 5 V _{pp} ¹⁾
Current consumption	≤ 20 mA ²⁾
Switching output	PNP
Output function	Complementary
Switching mode	Light/dark switching
Switching output detail	
Switching output Q1	PNP, Light switching
Switching output Q2	PNP, Dark switching
Output current I_{max.}	≤ 100 mA
Response time	≤ 0.5 ms ³⁾
Switching frequency	1,000 Hz ⁴⁾
Connection type	Cable with M12 male connector, 4-pin, 150 mm
Cable material	PVC
Conductor cross section	0.2 mm ²
Circuit protection	A ⁵⁾ B ⁶⁾ D ⁷⁾
Protection class	III
Weight	18 g
Housing material	Plastic, VISTAL®
Optics material	Plastic, PMMA
Enclosure rating	IP67 IP69K
Items supplied	Fastening nut (1x), M18, plastic, black, flat
Electromagnetic compatibility (EMC)	EN 60947-5-2 (The sensor complies with the Radio Safety Requirements (EMC) for the industrial sector (Radio Safety Class A). It may cause radio interference if used in a residential area.)
Ambient operating temperature	-40 °C ... +70 °C
Ambient temperature, storage	-40 °C ... +75 °C
UL File No.	E189383

¹⁾ May not exceed or fall below U_v tolerances.

²⁾ Without signal strength light bar and load.

³⁾ Signal transit time with resistive load.

⁴⁾ With light/dark ratio 1:1.

⁵⁾ A = V_S connections reverse-polarity protected.

⁶⁾ B = inputs and output reverse-polarity protected.

⁷⁾ D = outputs overcurrent and short-circuit protected.

Classifications

eCl@ss 5.0	27270901
eCl@ss 5.1.4	27270901
eCl@ss 6.0	27270901
eCl@ss 6.2	27270901
eCl@ss 7.0	27270901
eCl@ss 8.0	27270901

eCl@ss 8.1	27270901
eCl@ss 9.0	27270901
eCl@ss 10.0	27270901
eCl@ss 11.0	27270901
eCl@ss 12.0	27270901
ETIM 5.0	EC002716
ETIM 6.0	EC002716
ETIM 7.0	EC002716
ETIM 8.0	EC002716
UNSPSC 16.0901	39121528

Connection/pin assignment

Connection type	Cable with M12 male connector, 4-pin, 150 mm
Connection type Detail	
Conductor cross section	0.2 mm ²
Cable material	PVC
Pin assignment_{sender}	
BN 1	+ (L+)
WH 2	Not connected
BU 3	- (M)
BK 4	Test _{IN}
Pin assignment_{receiver}	
BN 1	+ (L+)
WH 2	Q ₂
BU 3	- (M)
BK 4	Q ₁

Dimensional drawing (Dimensions in mm (inch))

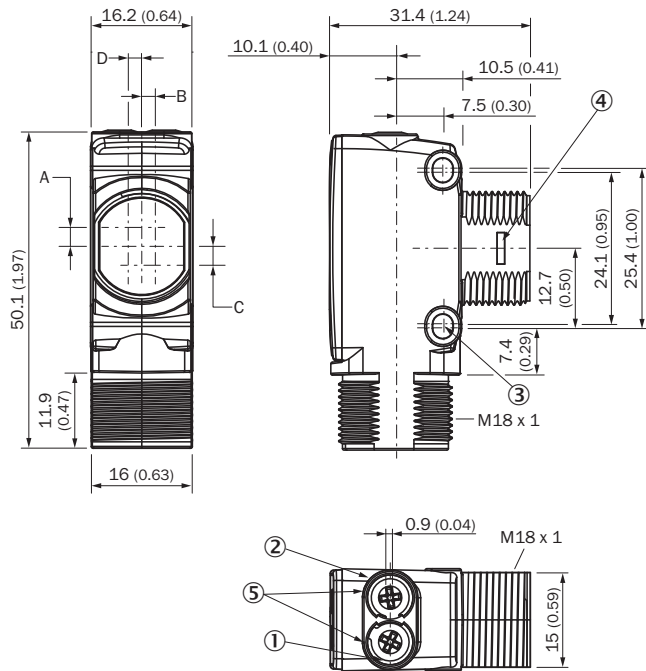

- ① LED indicator yellow: Status of received light beam
- ② LED indicator green: power on
- ③ M3 mounting hole
- ④ Snap Connection for flush ring (sold separately)
- ⑤ Potentiometer (if selected) or LED Indicators

Dimensions in mm (inch)	Receiver		Sender	
	A	B	C	D
HTB18 / HTF18	- 1.1 (0.04)	1.1 (0.04)	4.7 (0.19)	0.6 (0.02)
HTE18 / HL18 / HSE18	2.5 (0.1)	0.0 (0.0)	4.0 (0.16)	0.0 (0.0)
HTB18L / HTF18L / HL18L / HSE18L	2.5 (0.1)	0.0 (0.0)	3.5 (0.14)	0.0 (0.0)

Connection type

See table: **Connection/pin assignment**

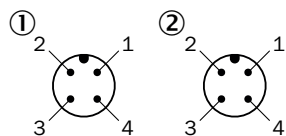

- ① Sender
- ② Receiver

Characteristic curve

Infrared light

Operating reserve

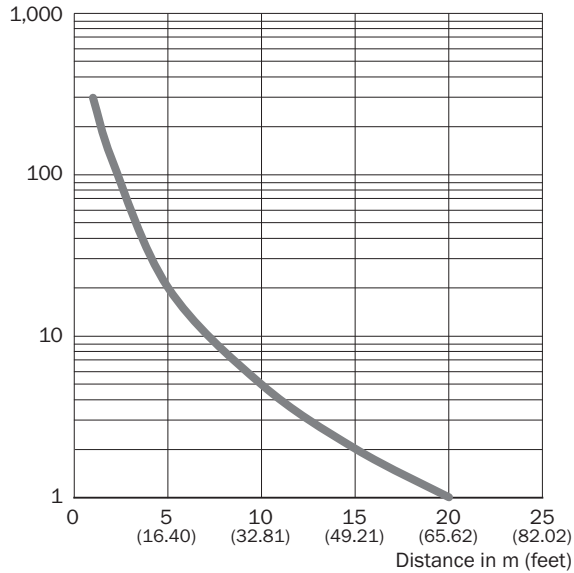

Light spot size

Infrared light

mm (inch)

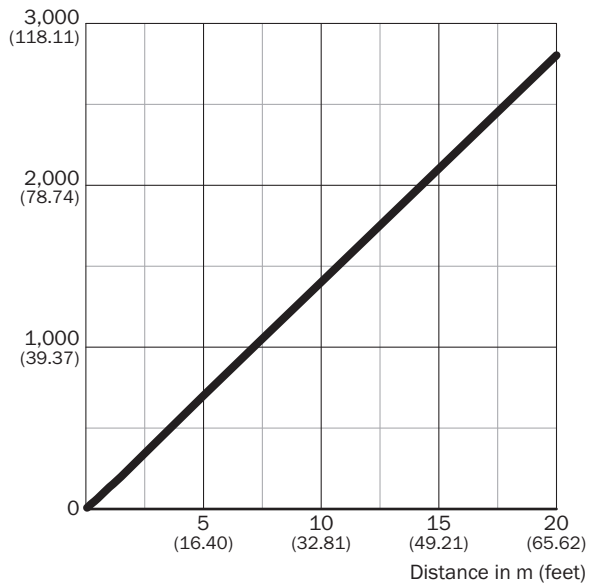

Dimensions in mm (inch)

Sensing range	Diameter
0.5 m (1.64 feet)	65 (0.21)
1 m (3.28 feet)	135 (5.31)
5 m (16.40 feet)	700 (27.56)
20 m (65.62 feet)	2,800 (110.24)

— Diameter

Sensing range diagram

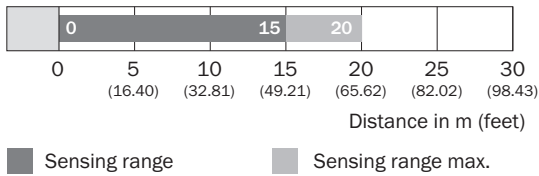

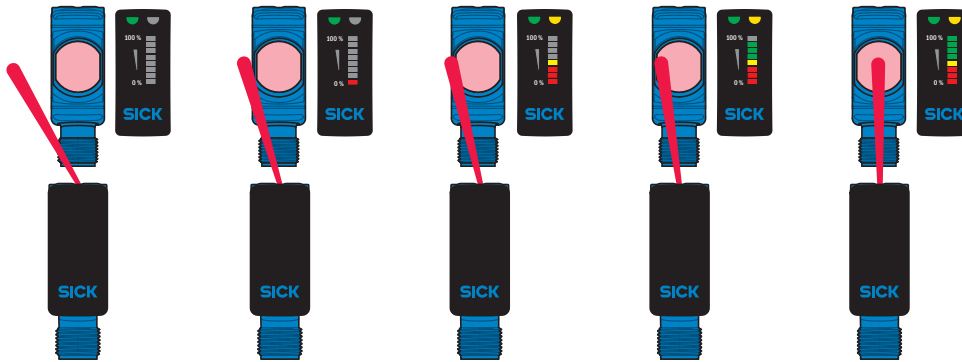

Functions



Recommended accessories

Other models and accessories → www.sick.com/H18_Sure_Sense

	Brief description	Type	Part no.
Plug connectors and cables			
	Head A: female connector, M12, 4-pin, straight, A-coded Head B: Flying leads Cable: Sensor/actuator cable, PVC, unshielded, 5 m	YF2A14-050VB3XLEAX	2096235
	Head A: male connector, M12, 4-pin, straight Cable: unshielded	STE-1204-G	6009932

SICK AT A GLANCE

SICK is one of the leading manufacturers of intelligent sensors and sensor solutions for industrial applications. A unique range of products and services creates the perfect basis for controlling processes securely and efficiently, protecting individuals from accidents and preventing damage to the environment.

We have extensive experience in a wide range of industries and understand their processes and requirements. With intelligent sensors, we can deliver exactly what our customers need. In application centers in Europe, Asia and North America, system solutions are tested and optimized in accordance with customer specifications. All this makes us a reliable supplier and development partner.

Comprehensive services complete our offering: SICK LifeTime Services provide support throughout the machine life cycle and ensure safety and productivity.

For us, that is “Sensor Intelligence.”

WORLDWIDE PRESENCE:

Contacts and other locations –www.sick.com