



VL180-2N41131S02

V180-2

CYLINDRICAL PHOTOELECTRIC SENSORS

SICK
Sensor Intelligence.



Ordering information

| Type | Part no. |
|------------------|----------|
| VL180-2N41131S02 | 6052349 |

Included in delivery: P250 (1)

Other models and accessories → www.sick.com/V180-2

Illustration may differ



Detailed technical data

Features

| | |
|--|--|
| Sensor/ detection principle | Photoelectric retro-reflective sensor, Dual lens |
| Dimensions (W x H x D) | 18 mm x 18 mm x 62.9 mm |
| Housing design (light emission) | Cylindrical |
| Housing length | 62.9 mm |
| Thread diameter (housing) | M18 x 1 |
| Optical axis | Axial |
| Sensing range max. | 0.05 m ... 7 m ¹⁾ |
| Sensing range | 0.05 m ... 6 m ¹⁾ |
| Type of light | Visible red light |
| Light source | LED ²⁾ |
| Light spot size (distance) | Ø 400 mm (6 m) |
| Angle of dispersion | Approx. 4.5° |
| Wave length | 645 nm |
| Adjustment | Potentiometer, 270° (Sensitivity) |
| Special features | Fix adjustment without potentiometer |

¹⁾ Reflector PL80A.

²⁾ Average service life: 100,000 h at T_U = +25 °C.

Mechanics/electronics

| | |
|-----------------------|-----------------------------------|
| Supply voltage | 10 V DC ... 30 V DC ¹⁾ |
|-----------------------|-----------------------------------|

¹⁾ Limit values when operated in short-circuit protected network: max. 8 A.

²⁾ May not exceed or fall below U_V tolerances.

³⁾ Without load.

⁴⁾ Control wire open: light switching L.ON.

⁵⁾ Signal transit time with resistive load.

⁶⁾ With light/dark ratio 1:1.

⁷⁾ Do not bend below 0 °C.

⁸⁾ A = V_S connections reverse-polarity protected.

⁹⁾ B = inputs and output reverse-polarity protected.

¹⁰⁾ D = outputs overcurrent and short-circuit protected.

| | |
|--|--|
| Ripple | ± 10 % ²⁾ |
| Current consumption | 30 mA ³⁾ |
| Switching output | NPN ⁴⁾ |
| Switching mode | Light/dark switching ⁴⁾ |
| Switching mode selector | Selectable via L/D control cable |
| Signal voltage NPN HIGH/LOW | Approx. $V_S / < 1.8 V$ |
| Output current I_{max} | ≤ 100 mA |
| Response time | ≤ 0.5 ms ⁵⁾ |
| Switching frequency | 1,000 Hz ⁶⁾ |
| Connection type | Cable, 4-wire, 2 m ⁷⁾ |
| Cable material | PVC |
| Conductor cross-section | 0.18 mm ² |
| Cable diameter | Ø 3.8 mm |
| Circuit protection | A ⁸⁾ B ⁹⁾ D ¹⁰⁾ |
| Protection class | III |
| Weight | 95 g |
| Polarisation filter | ✓ |
| Special device | ✓ |
| Housing material | Metal, Nickel-plated brass and PC |
| Optics material | Plastic, PMMA |
| Enclosure rating | IP67 |
| Items supplied | Reflector P250, fastening nuts (2 x) |
| Ambient operating temperature | -25 °C ... +55 °C |
| Ambient storage temperature | -40 °C ... +70 °C |

¹⁾ Limit values when operated in short-circuit protected network: max. 8 A.

²⁾ May not exceed or fall below U_V tolerances.

³⁾ Without load.

⁴⁾ Control wire open: light switching L.ON.

⁵⁾ Signal transit time with resistive load.

⁶⁾ With light/dark ratio 1:1.

⁷⁾ Do not bend below 0 °C.

⁸⁾ A = V_S connections reverse-polarity protected.

⁹⁾ B = inputs and output reverse-polarity protected.

¹⁰⁾ D = outputs overcurrent and short-circuit protected.

Safety-related parameters

| | |
|-------------------------|---------------|
| MTTF_D | 1,899.4 years |
| DC_{avg} | 0% |

Classifications

| | |
|---------------------|----------|
| ECI@ss 5.0 | 27270902 |
| ECI@ss 5.1.4 | 27270902 |
| ECI@ss 6.0 | 27270902 |

VL180-2N41131S02 | V180-2

CYLINDRICAL PHOTOELECTRIC SENSORS

| | |
|-----------------------|----------|
| ECl@ss 6.2 | 27270902 |
| ECl@ss 7.0 | 27270902 |
| ECl@ss 8.0 | 27270902 |
| ECl@ss 8.1 | 27270902 |
| ECl@ss 9.0 | 27270902 |
| ECl@ss 10.0 | 27270902 |
| ECl@ss 11.0 | 27270902 |
| ETIM 5.0 | EC002717 |
| ETIM 6.0 | EC002717 |
| ETIM 7.0 | EC002717 |
| UNSPSC 16.0901 | 39121528 |

Connection diagram

Cd-089

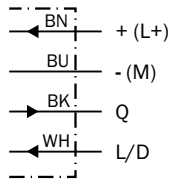

Characteristic curve

VL180-2, 7 m, axial

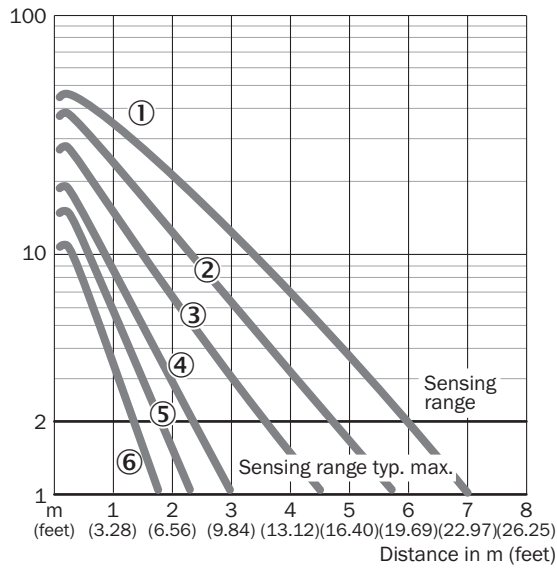

- ① Reflector PL80A
- ② Reflector P250, PL40A, PL50A, C110A
- ③ Reflector PL30A, PL31A
- ④ Reflector PL20A
- ⑤ P45
- ⑥ Reflective tape Diamond Grade

Light spot size

VL180-2

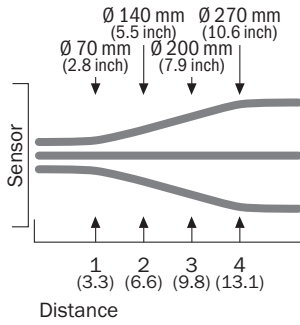

Sensing range diagram

VL180-2, 7 m, axial

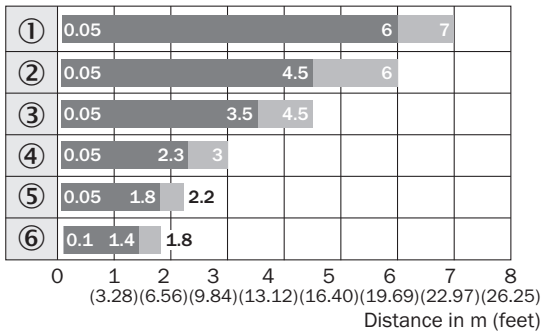

■ Sensing range ■ Sensing range max.

- ① Reflector PL80A
- ② Reflector P250, PL40A, PL50A, C110A
- ③ Reflector PL30A, PL31A
- ④ Reflector PL20A
- ⑤ P45
- ⑥ Reflective tape Diamond Grade

Adjustments

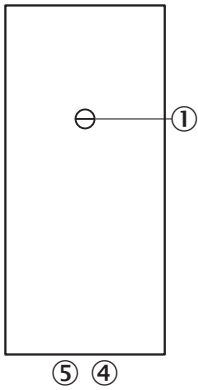

- ③ Sensitivity control 270°
- ④ LED indicator orange: switching output active
- ⑤ LED indicator green

Dimensional drawing (Dimensions in mm (inch))

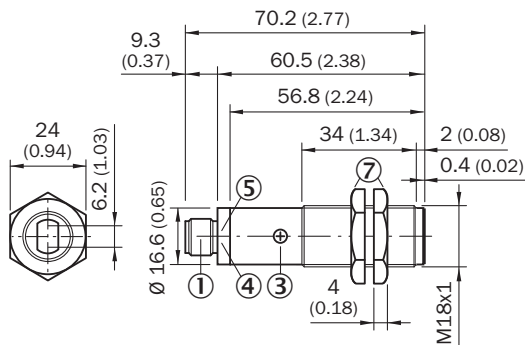
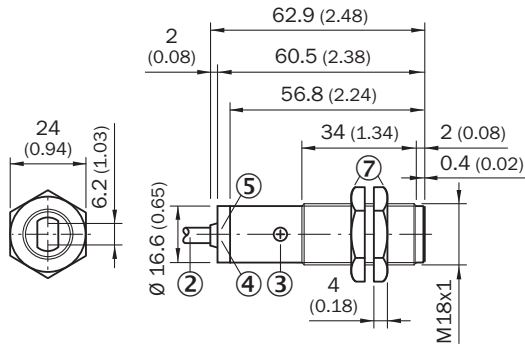

VL180-2, metal, axial



- ① M12 male device connector, 4-pin
- ② Connection cable 2 m
- ③ Sensitivity control 270°
- ④ LED indicator orange: switching output active
- ⑤ LED indicator green: strength indicator
- ⑦ Fastening nuts (2x); width across 24, metal

Recommended accessories

Other models and accessories → www.sick.com/V180-2

| | Brief description | Type | Part no. |
|---|---|------------|----------|
| Reflectors | | | |
|  | Rectangular, screw connection, 51 mm x 61 mm, PMMA/ABS, Screw-on, 2 hole mounting | P250 | 5304812 |
| Plug connectors and cables | | | |
|  | Head A: male connector, M12, 4-pin, straight Head B: - Cable: unshielded | STE-1204-G | 6009932 |

SICK AT A GLANCE

SICK is one of the leading manufacturers of intelligent sensors and sensor solutions for industrial applications. A unique range of products and services creates the perfect basis for controlling processes securely and efficiently, protecting individuals from accidents and preventing damage to the environment.

We have extensive experience in a wide range of industries and understand their processes and requirements. With intelligent sensors, we can deliver exactly what our customers need. In application centers in Europe, Asia and North America, system solutions are tested and optimized in accordance with customer specifications. All this makes us a reliable supplier and development partner.

Comprehensive services complete our offering: SICK LifeTime Services provide support throughout the machine life cycle and ensure safety and productivity.

For us, that is “Sensor Intelligence.”

WORLDWIDE PRESENCE:

Contacts and other locations –www.sick.com