



WSE4FP-21312100ZZZ

W4F

MINIATURE PHOTOELECTRIC SENSORS

SICK
Sensor Intelligence.



Ordering information

Type	Part no.
WSE4FP-21312100ZZZ	1120404

Other models and accessories → www.sick.com/W4F

Illustration may differ



Detailed technical data

Features

Functional principle	Through-beam photoelectric sensor
Sensing range	
Sensing range min.	0 m
Sensing range max.	10 m
Maximum distance range from receiver to sender (operating reserve 1)	0 m ... 10 m
Recommended distance range from receiver to sender (operating reserve 2)	0 m ... 7.5 m
Recommended sensing range for the best performance	0 m ... 7.5 m
Emitted beam	
Light source	PinPoint LED
Type of light	Visible red light
Shape of light spot	Point-shaped
Light spot size (distance)	Ø 40 mm (1,000 mm)
Maximum dispersion of the emitted beam around the standardized transmission axis (squint angle)	< +/- 1.5° (at T _a = +23 °C)
Key LED figures	
Normative reference	EN 62471:2008-09 IEC 62471:2006, modified
LED risk group marking	Free group
Wave length	635 nm
Average service life	100,000 h at T _a = +25 °C
Adjustment	
Wire/pin	For deactivation of the sender and execution of test logic
Indication	

LED blue	BluePilot: Alignment aid
LED green	Operating indicator Static: power on
LED yellow	Status of received light beam Static: object not present Static off: object present

Safety-related parameters

MTTF_D	574 years
DC_{avg}	0 %
T_M (mission time)	20 years

Electrical data

Supply voltage U_B	10 V DC ... 30 V DC ¹⁾
Ripple	≤ 5 V _{pp}
Use category (according to EN 60947-5-2)	DC-12, DC-13
Power consumption	≤ 20 mA, without load. At U _B = 24 V
Protection class	III
Digital output	
Number	1
Type	Push-pull: PNP/NPN
Signal voltage PNP HIGH/LOW	Approx. U _B -2.5 V / 0 V
Signal voltage NPN HIGH/LOW	Approx. U _B / < 2.5 V
Output current I _{max.}	≤ 100 mA
Circuit protection outputs	Reverse polarity protected Overcurrent protected Short-circuit protected
Response time	≤ 500 μs
Switching frequency	1,000 Hz ²⁾
Pin/Wire assignment, sender	
Function of pin 4/black (BK)	Input, sender off, LOW active
Pin/Wire assignment, receiver	
Function of pin 4/black (BK)	Digital output, light switching, object present → output Q LOW

¹⁾ Limit values.

²⁾ With light/dark ratio 1:1.

Mechanical data

Housing	Rectangular
Dimensions (W x H x D)	16 mm x 40.1 mm x 12.1 mm
Connection	Connector M8, 3-pin
Material	
Housing	Plastic, VISTAL®
Front screen	Plastic, PMMA
Male connector	Plastic, VISTAL®
LABS-free	Yes (VDMA 24364-A1-L)
Weight	Approx. 30 g

Maximum tightening torque of the fixing screws	0.4 Nm
-------------------------------------------------------	--------

Ambient data

Enclosure rating	IP66 (EN 60529) IP67 (EN 60529)
Ambient operating temperature	-40 °C ... +60 °C
Ambient temperature, storage	-40 °C ... +75 °C
Typ. Ambient light immunity	Artificial light: ≤ 15,000 lx Sunlight: ≤ 50,000 lx
Shock resistance	30 g, 11 ms (3 positive and 3 negative shocks along X, Y, Z axes, 18 total shocks (EN60068-2-27))
Vibration resistance	10 Hz ... 1,000 Hz (Amplitude 1 mm, 3x30 min (EN60068-2-6))
Air humidity	35 % ... 95 %, relative humidity (no condensation)
Electromagnetic compatibility (EMC)	EN 60947-5-2
Resistance to cleaning agent	ECOLAB
UL File No.	NRKH.E181493 & NRKH7.E181493

Classifications

ECl@ss 5.0	27270901
ECl@ss 5.1.4	27270901
ECl@ss 6.0	27270901
ECl@ss 6.2	27270901
ECl@ss 7.0	27270901
ECl@ss 8.0	27270901
ECl@ss 8.1	27270901
ECl@ss 9.0	27270901
ECl@ss 10.0	27270901
ECl@ss 11.0	27270901
ETIM 5.0	EC002716
ETIM 6.0	EC002716
ETIM 7.0	EC002716
ETIM 8.0	EC002716
UNSPSC 16.0901	39121528

Connection type

Connector M8, 3-pin

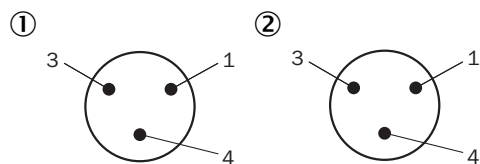

- ① Sender
- ② Receiver

Connection diagram

Cd-518

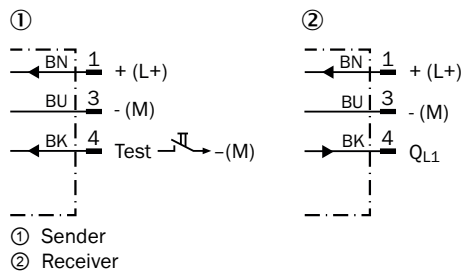

Truth table

Push-pull: PNP/NPN – dark switching \bar{Q}

	Dark switching \bar{Q} (normally open (upper switch), normally closed (lower switch))	
	Object not present → Output LOW	Object present → Output HIGH
Light receive	✓	✗
Light receive indicator	☀	✗
Load resistance to L+	⚠	✗
Load resistance to M	✗	⚠

Push-pull: PNP/NPN - light switching Q

	Light switching Q (normally closed (upper switch), normally open (lower switch))	
	Object not present → Output HIGH	Object present → Output LOW
Light receive	✓	✗
Light receive indicator	☀	✗
Load resistance to L+	✗	⚠
Load resistance to M	⚠	✗

Characteristic curve

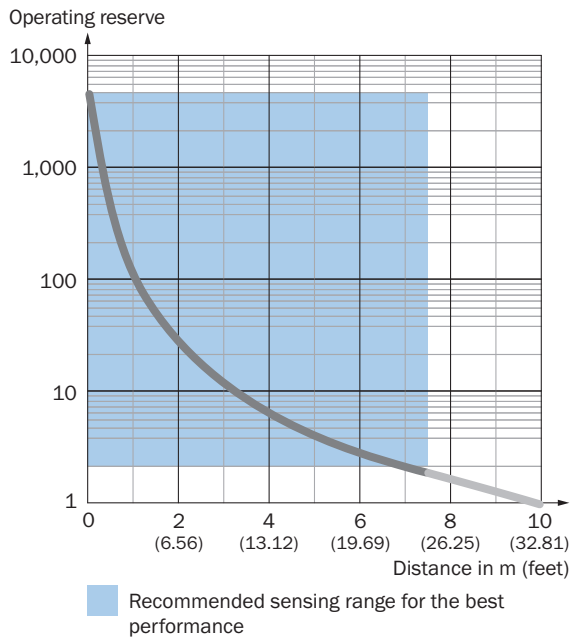

Light spot size

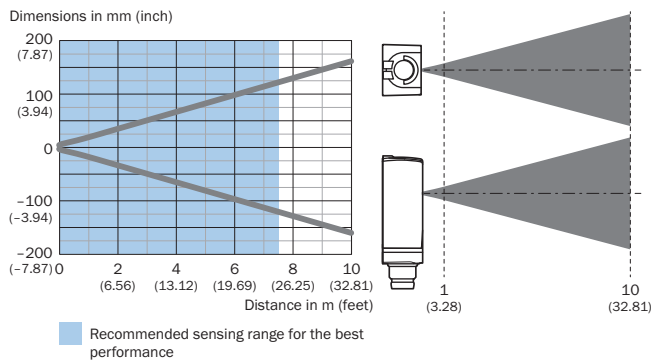

Sensing range diagram

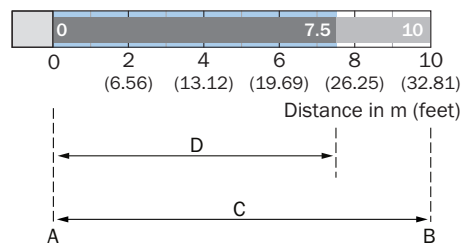

- A = Sensing range min. in m
- B = Sensing range max. in m
- C = Maximum distance range from receiver to sender
- D = Recommended distance range from receiver to sender
- Recommended sensing range for the best performance

Adjustments

Display and adjustment elements

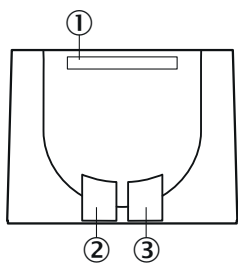

- ① LED blue
- ② LED green
- ③ LED yellow

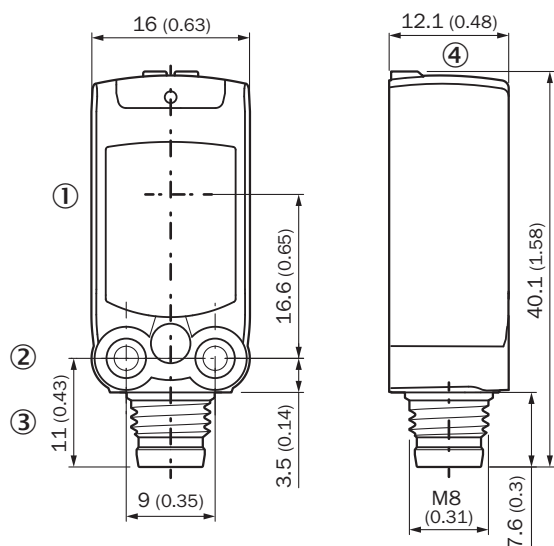

Dimensional drawing (Dimensions in mm (inch))



- ① Center of optical axis
- ② M3 mounting hole
- ③ Connection
- ④ Display and adjustment elements

Recommended accessories

Other models and accessories → www.sick.com/W4F

	Brief description	Type	Part no.
Mounting brackets and plates			
	Mounting bracket for wall mounting, Stainless steel 1.4571, mounting hardware included	BEF-W4-A	2051628
Plug connectors and cables			
	Head A: female connector, M8, 3-pin, straight, A-coded Head B: Flying leads Cable: Sensor/actuator cable, PVC, unshielded, 5 m	YF8U13-050VA1XLEAX	2095884
	Head A: male connector, M8, 3-pin, straight Head B: - Cable: unshielded	STE-0803-G	6037322

SICK AT A GLANCE

SICK is one of the leading manufacturers of intelligent sensors and sensor solutions for industrial applications. A unique range of products and services creates the perfect basis for controlling processes securely and efficiently, protecting individuals from accidents and preventing damage to the environment.

We have extensive experience in a wide range of industries and understand their processes and requirements. With intelligent sensors, we can deliver exactly what our customers need. In application centers in Europe, Asia and North America, system solutions are tested and optimized in accordance with customer specifications. All this makes us a reliable supplier and development partner.

Comprehensive services complete our offering: SICK LifeTime Services provide support throughout the machine life cycle and ensure safety and productivity.

For us, that is “Sensor Intelligence.”

WORLDWIDE PRESENCE:

Contacts and other locations –www.sick.com