



WTM10L-241611D0A00ZVZZZZZZZZZZ1

W10

HYBRID PHOTOELECTRIC SENSORS

SICK
Sensor Intelligence.



Illustration may differ



Ordering information

Type	Part no.
WTM10L-241611D0A00ZVZZZZZZZZ1	1133547

Other models and accessories → www.sick.com/W10

Detailed technical data

Features

Functional principle	Photoelectric proximity sensor
Functional principle detail	Background suppression, Foreground suppression, MultiMode
MultiMode	Background suppression Foreground suppression 1-point teach-in 2-point teach-in Manual teach-in ApplicationSelect (Mode 1 - Speed, Mode 2 - Standard, Mode 3 - Precision) Measurement
Sensing range	
Sensing range min.	25 mm (Mode 1 - Speed) 25 mm (Mode 2 - Standard) 25 mm (Mode 3 - Precision)
Sensing range max.	300 mm (Mode 1 - Speed) 500 mm (Mode 2 - Standard) 700 mm (Mode 3 - Precision)
Adjustable switching threshold for background suppression	25 mm ... 300 mm (Mode 1 - Speed) 25 mm ... 500 mm (Mode 2 - Standard) 25 mm ... 700 mm (Mode 3 - Precision)
Reference object	Object with 90% remission factor (complies with standard white according to DIN 5033)
Minimum distance between set sensing range and background (black 6% / white 90%)	6 mm, at a distance of 250 mm (Mode 1 - Speed) 8 mm, at a distance of 400 mm (Mode 2 - Standard) 10 mm, at a distance of 500 mm (Mode 3 - Precision)

¹⁾ 90% remission factor.

²⁾ Equivalent to 1 σ .

³⁾ Observe min. warm-up time of 15 minutes.

Recommended sensing range for the best performance	50 mm ... 250 mm (Mode 1 - Speed) 50 mm ... 400 mm (Mode 2 - Standard) 50 mm ... 500 mm (Mode 3 - Precision)
Distance value	
Measuring range	25 mm ... 700 mm
Resolution	1 mm
Repeatability	< 0,5 % ^{1) 2) 3)}
Accuracy	< 4 % ¹⁾
Distance value output	Via IO-Link + display
Emitted beam	
Light source	Laser
Type of light	Visible red light
Shape of light spot	Point-shaped
Light spot size (distance)	Ø 0.4 mm (250 mm)
Maximum dispersion of the emitted beam around the standardized transmission axis (squint angle)	< +/- 1.0° (at Ta = +23 °C)
Key laser figures	
Normative reference	IEC 60825-1 / CDRH 21 CFR 1040.10 & 1040.11, EN 60825-1:2014, IEC 60825-1:2014 (except for tolerances according to Laser Notice No. 56 dated May 8, 2019)
Laser class	1
Wave length	655 nm
Pulse duration	4 µs
Maximum pulse power	< 2.5 mW
Average service life	50,000 h at T _U = +25 °C
Smallest detectable object (MDO) typ.	
	0.6 mm (at a distance of 250 mm) Object with 90% remission factor (complies with standard white according to DIN 5033)
Adjustment	
Touch display	For setting the sensing range and configuring the sensor parameters
IO-Link	For configuring the sensor parameters and Smart Task functions
Indication	
Display	Display of mode, display of output states, display of the distance value, display of the set value
LED green	Operating indicator Static on: power on Flashing: IO-Link mode
LED yellow	Status of received light beam Static on: object present Static off: object not present
Special features	MultiMode
Special applications	Detecting small objects, Detection of objects moving at high speeds, Detecting flat objects, Detecting uneven, shiny objects, Detection of poorly remitting and tilted objects

¹⁾ 90% remission factor.

²⁾ Equivalent to 1 σ.

³⁾ Observe min. warm-up time of 15 minutes.

Safety-related parameters

MTTF_D	473 years
DC_{avg}	0 %
T_M (mission time)	10 years (rate of use: 60 %)

Communication interface

IO-Link	✓, IO-Link V1.1
Data transmission rate	COM2 (38,4 kBaud)
Cycle time	3.4 ms
Process data length	32 Bit
Process data structure	Bit 0 = switching signal Q _{L1} Bit 1 = switching signal Q _{L2} Bit 2 ... 5 = Qint.1 ... Qint.4 Bit 6 = Operating status of the sensor Bit 7 ... 15 = Empty Bit 16 ... 31 = Distance to object
VendorID	26
DeviceID HEX	0x80032E
DeviceID DEC	8389422
Compatible master port type	A
SIO mode support	Yes

Electrical data

Supply voltage U_B	10 V DC ... 30 V DC ¹⁾
Ripple	≤ 5 V _{pp}
Usage category	DC-12 (According to EN 60947-5-2) DC-13 (According to EN 60947-5-2)
Current consumption	≤ 25 mA, without load. At U _B = 24 V
Protection class	III
Digital output	
Number	2
Type	Push-pull: PNP/NPN Individually adjustable
Switching mode	Light/dark switching
Output characteristic	Individually adjustable
Signal voltage PNP HIGH/LOW	Approx. U _B -2.0 V / 0 V
Signal voltage NPN HIGH/LOW	Approx. U _B -1.0 V / < 2.5 V
Output current I _{max.}	≤ 100 mA
Circuit protection outputs	Reverse polarity protected Overcurrent protected Short-circuit protected
Response time	1.8 ms, 5 ms, 15 ms (Mode 1 - Speed, Mode 2 - Standard, Mode 3 - Precision) ^{2) 2) 2)}
Repeatability (response time)	< 0,5 %
Switching frequency	275 Hz, 100 Hz, 30 Hz (Mode 1 - Speed, Mode 2 - Standard, Mode 3 - Precision) ^{3) 3) 3)}

¹⁾ Limit values.

²⁾ Signal transit time with resistive load in switching mode.

³⁾ With light/dark ratio 1:1.

Pin/Wire assignment	
BN 1	+ (L+)
WH 2	\bar{Q}_{L1} /MF Digital output, dark switching, object present → output \bar{Q}_{L1} LOW (background suppression)digital output, light switching, object present → output QL1 LOW (foreground suppression) The pin 2 function of the sensor can be configuredAdditional possible settings via IO-Link
BU 3	-(M)
BK 4	QL1/C Digital output, light switching, object present → output QL1 HIGH (background suppression)digital output, dark switching, object present → output \bar{Q}_{L1} HIGH (foreground suppression)IO-Link communication C The pin 4 function of the sensor can be configuredAdditional possible settings via IO-Link

1) Limit values.

2) Signal transit time with resistive load in switching mode.

3) With light/dark ratio 1:1.

Mechanical data

Housing	Rectangular
Dimensions (W x H x D)	18 mm x 57 mm x 42.2 mm
Connection	Male connector M12, 4-pin
Material	
Housing	Stainless steel, Stainless steel V4A (1.4404, 316L)
Front screen	Plastic, PMMA
Display cover	Plastic, PMMA
LED	Plastic, ABS
Male connector	Stainless steel, Stainless steel V4A (1.4404, 316L)
Weight	Approx. 100 g
Maximum tightening torque of the fixing screws	0.56 Nm

Ambient data

Enclosure rating	IP67 (EN 60529) IP69 (Replaces IP69K with ISO 20653: 2013-03)
Ambient operating temperature	-10 °C ... +55 °C
Ambient temperature, storage	-40 °C ... +75 °C
Warm-up time	Observe min. warm-up time of 15 minutes ¹⁾
Typ. Ambient light immunity	Artificial light: ≤ 10,000 lx Sunlight: ≤ 10,000 lx
Air humidity	35 % ... 95 %, relative humidity (no condensation)
Electromagnetic compatibility (EMC)	EN 60947-5-2, The sensor complies with the Radio Safety Requirements (EMC) for the industrial sector (Radio Safety Class A). It may cause radio interference if used in a residential area.

¹⁾ During the device warm-up phase, the measured values are subject to increased scatter (temperature drift).

Smart Task

Smart Task name	Base logics
Logic function	Direct AND OR Window Hysteresis

Timer function	Deactivated Switch-on delay Off delay ON and OFF delay Impulse (one shot)
Inverter	Yes
Switching signal	
Switching signal Q_{L1}	Switching output
Switching signal \bar{Q}_{L1}	Switching output

Diagnosis

Device temperature	
Measuring range	Very cold, cold, moderate, warm, hot
Device status	Yes
Detailed device status	Yes
Operating hour counter	Yes
Operating hours counter with reset function	Yes

Classifications

ECLASS 5.0	27270904
ECLASS 5.1.4	27270904
ECLASS 6.0	27270904
ECLASS 6.2	27270904
ECLASS 7.0	27270904
ECLASS 8.0	27270904
ECLASS 8.1	27270904
ECLASS 9.0	27270904
ECLASS 10.0	27270904
ECLASS 11.0	27270904
ECLASS 12.0	27270903
ETIM 5.0	EC002719
ETIM 6.0	EC002719
ETIM 7.0	EC002719
ETIM 8.0	EC002719
UNSPSC 16.0901	39121528

Dimensional drawing (Dimensions in mm (inch))

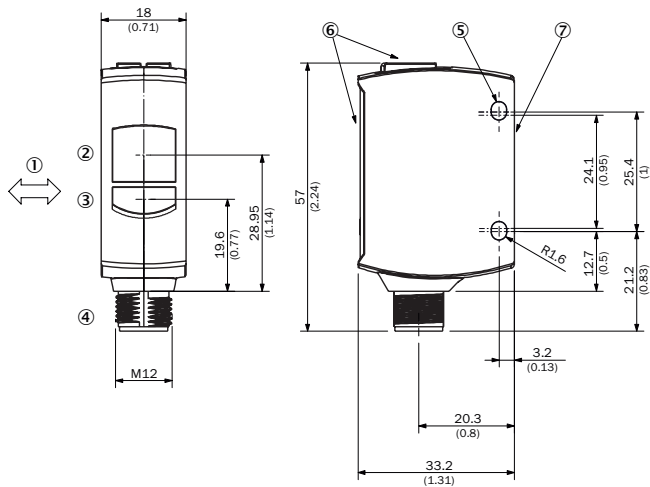

- ① Standard direction of the material being detected
- ② Center of optical axis, receiver
- ③ Center of optical axis, sender
- ④ Connection
- ⑤ Mounting hole, \varnothing 3.2 mm
- ⑥ Display and adjustment elements
- ⑦ Zero point measurement range

Adjustments

Display and adjustment elements

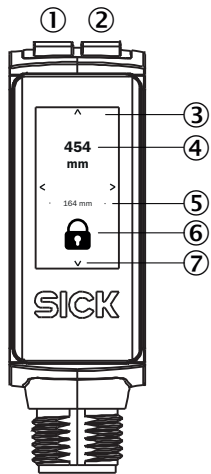

- ① LED green
- ② LED yellow
- ③ Touch display
- ④ Current distance
- ⑤ Distance of last good teach-in
- ⑥ Lock/unlock status indicator
- ⑦ Display navigation arrows

Connection type

M12 male connector, 4-pin

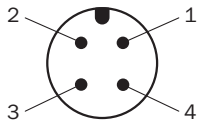

Connection diagram

Cd-561 (background suppression)

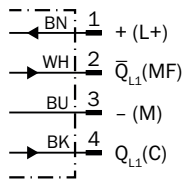

Cd-562 (foreground suppression)

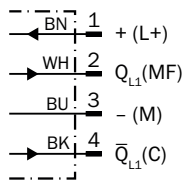

Truth table

Push-pull: PNP/NPN - dark switching \bar{Q} (foreground suppression)

	Dark switching \bar{Q} (normally open (upper switch), normally closed (lower switch))	
	Object not present → Output LOW	Object present → Output HIGH
Light receive	✓	✗
Light receive indicator	☀	✗
Load resistance to L+	⚠	✗
Load resistance to M	✗	⚠

Push-pull: PNP/NPN - dark switching \bar{Q} (background suppression)

	Dark switching \bar{Q} (normally closed (upper switch), normally open (lower switch))	
	Object not present → Output HIGH	Object present → Output LOW
Light receive	⊗	☑
Light receive indicator	⊗	☀
Load resistance to L+	⊗	⚠
Load resistance to M	⚠	⊗

Push-pull: PNP/NPN - light switching Q (foreground suppression)

	Light switching Q (normally closed (upper switch), normally open (lower switch))	
	Object not present → Output HIGH	Object present → Output LOW
Light receive	☑	⊗
Light receive indicator	☀	⊗
Load resistance to L+	⊗	⚠
Load resistance to M	⚠	⊗

Push-pull: PNP/NPN - light switching Q (background suppression)

	Light switching Q (normally open (upper switch), normally closed (lower switch))	
	Object not present → Output LOW	Object present → Output HIGH
Light receive	⊗	☑
Light receive indicator	⊗	☀
Load resistance to L+	⚠	⊗
Load resistance to M	⊗	⚠

Characteristic curve

Foreground suppression

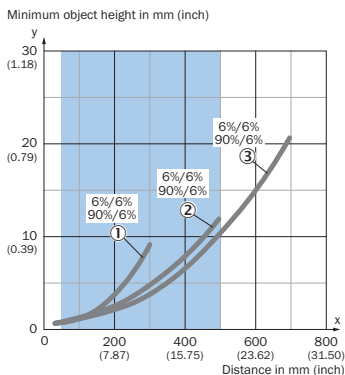

Recommended sensing range for the best performance

Example: Reliable detection of the object

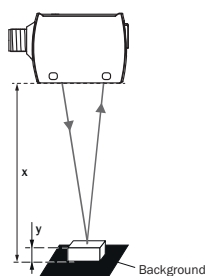

Black background (6% remission factor)
Distance of sensor to background $x = 500$ mm
Required minimum object height $y = 10$ mm
For all objects regardless of their colors

- ① Black object, 6% remission factor, Mode 1 - Speed
- ② Black object, 6% remission factor, Mode 2 - Standard
- ③ Black object, 6% remission factor, Mode 3 - Precision

Background suppression

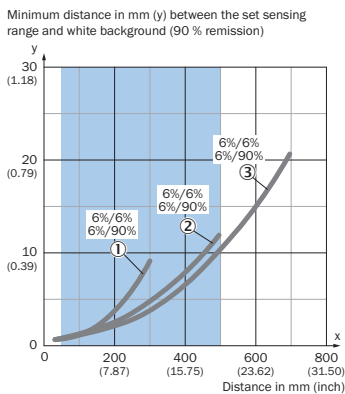

Recommended sensing range for the best performance

Example: Safe suppression of the background

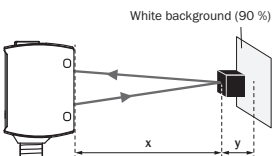

Black object (6% remission)
Set sensing range $x = 500$ mm
Needed minimum distance to white background $y = 10$ mm

- ① Black object, 6% remission factor, Mode 1 - Speed
- ② Black object, 6% remission factor, Mode 2 - Standard
- ③ Black object, 6% remission factor, Mode 3 - Precision

Light spot size

Background suppression

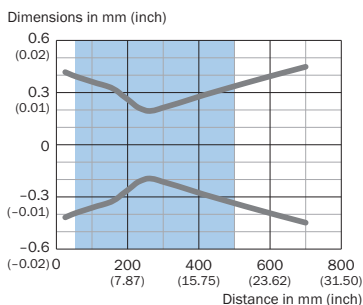

Recommended sensing range for the best performance

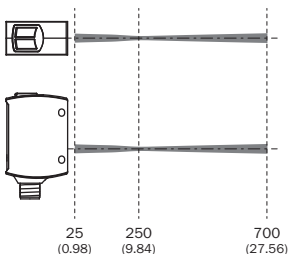

Sensing range diagram

Background suppression

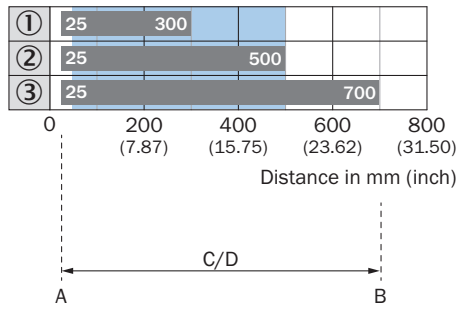



Recommended sensing range for the best performance

1	Black object, 6% remission factor, Mode 1 - Speed
2	Black object, 6% remission factor, Mode 2 - Standard
3	Black object, 6% remission factor, Mode 3 - Precision
A	Sensing range min. in mm
B	Sensing range max. in mm
C	Field of view
D	Adjustable switching threshold for background suppression

Recommended accessories

Other models and accessories → www.sick.com/W10

	Brief description	Type	Part no.
Others			
	<ul style="list-style-type: none"> Connection type head A: Female connector, M12, 4-pin, straight, A-coded Connection type head B: Flying leads Signal type: Sensor/actuator cable Cable: 5 m, 4-wire, PVC Description: Sensor/actuator cable, unshielded Application: Zones with chemicals 	YF2A14-050VB3XLEAX	2096235
Sensor Integration Gateway			
	<ul style="list-style-type: none"> Further functions: Web server integrated, IIoT interface available (dual talk) Logic editor: no Communication interface: IO-Link, Ethernet, PROFINET, REST API, MQTT, OPC UA Product category: IO-Link Master 	SIG350-0004AP100	6076871

SICK AT A GLANCE

SICK is one of the leading manufacturers of intelligent sensors and sensor solutions for industrial applications. A unique range of products and services creates the perfect basis for controlling processes securely and efficiently, protecting individuals from accidents and preventing damage to the environment.

We have extensive experience in a wide range of industries and understand their processes and requirements. With intelligent sensors, we can deliver exactly what our customers need. In application centers in Europe, Asia and North America, system solutions are tested and optimized in accordance with customer specifications. All this makes us a reliable supplier and development partner.

Comprehensive services complete our offering: SICK LifeTime Services provide support throughout the machine life cycle and ensure safety and productivity.

For us, that is “Sensor Intelligence.”

WORLDWIDE PRESENCE:

Contacts and other locations –www.sick.com