



WLG4S-3P5232H

W4S-3 Inox Hygiene Glass

MINIATURE PHOTOELECTRIC SENSORS

SICK
Sensor Intelligence.



Illustration may differ



Ordering information

Type	Part no.
WLG4S-3P5232H	1057053

Other models and accessories → www.sick.com/W4S-3_Inox_Hygiene_Glass

Detailed technical data

Features

Sensor/ detection principle	Photoelectric retro-reflective sensor, autocollimation
Dimensions (W x H x D)	15.25 mm x 63.2 mm x 22.15 mm
Housing design	Hygiene
Housing design (light emission)	Rectangular
Sensing range max.	0 m ... 5 m ¹⁾
Sensing range	0 m ... 3 m ¹⁾
Type of light	Visible red light
Light source	PinPoint LED ²⁾
Light spot size (distance)	Ø 45 mm (1.5 m)
Wave length	650 nm
Adjustment	Single teach-in button
AutoAdapt	✓
Special applications	Hygienic and washdown zones, Detecting transparent objects

¹⁾ Reflector PL80A.

²⁾ Average service life: 100,000 h at T_J = +25 °C.

Mechanics/electronics

Supply voltage	10 V DC ... 30 V DC ¹⁾
Ripple	< 5 V _{pp} ²⁾
Current consumption	30 mA ³⁾
Switching output	PNP
Switching mode	Light/dark switching
Output current I_{max.}	≤ 100 mA
Response time	< 0.5 ms ⁴⁾
Switching frequency	1,000 Hz ⁵⁾
Attenuation along light beam	> 8 %
Connection type	Male connector M8, 4-pin ⁶⁾
Mechanical connection	D12 adapter shaft
Circuit protection	A, B, C ^{7) 8) 9)}
Protection class	III
Weight	140 g
Polarisation filter	✓
Housing material	Stainless steel, Stainless steel V4A (1.4404, 316L)
Optics material	Plastic, PMMA
Enclosure rating	IP66 IP67 IP68 IP69K
Special feature	Detecting transparent objects, D12 adapter shaft
Ambient operating temperature	-30 °C ... +70 °C ¹⁰⁾ -30 °C ... +60 °C
Ambient temperature, storage	-30 °C ... +75 °C
UL File No.	FDA, UL No. NRKH.E181493 & cUL No. NRKH7.E181493

¹⁾ Limit values, reverse-polarity protected, operation in short-circuit protected network: max. 8 A.

²⁾ May not exceed or fall below U_v tolerances.

³⁾ Without load.

⁴⁾ Signal transit time with resistive load.

⁵⁾ With light/dark ratio 1:1.

⁶⁾ Max. tightening torque: 0.6 Nm.

⁷⁾ A = V_S connections reverse-polarity protected.

⁸⁾ B = inputs and output reverse-polarity protected.

⁹⁾ C = interference suppression.

¹⁰⁾ At UV ≤ 24 V and IA < 30 mA.

Safety-related parameters

MTTF_D	1,232 years
DC_{avg}	0 %

Classifications

ECl@ss 5.0	27270902
ECl@ss 5.1.4	27270902
ECl@ss 6.0	27270902

ECl@ss 6.2	27270902
ECl@ss 7.0	27270902
ECl@ss 8.0	27270902
ECl@ss 8.1	27270902
ECl@ss 9.0	27270902
ECl@ss 10.0	27270902
ECl@ss 11.0	27270902
ETIM 5.0	EC002717
ETIM 6.0	EC002717
ETIM 7.0	EC002717
ETIM 8.0	EC002717
UNSPSC 16.0901	39121528

Connection diagram

Cd-083

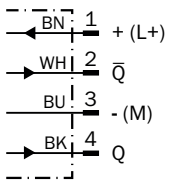

Characteristic curve

WL4S-3, WLG4S-3, 5 m

Operating reserve

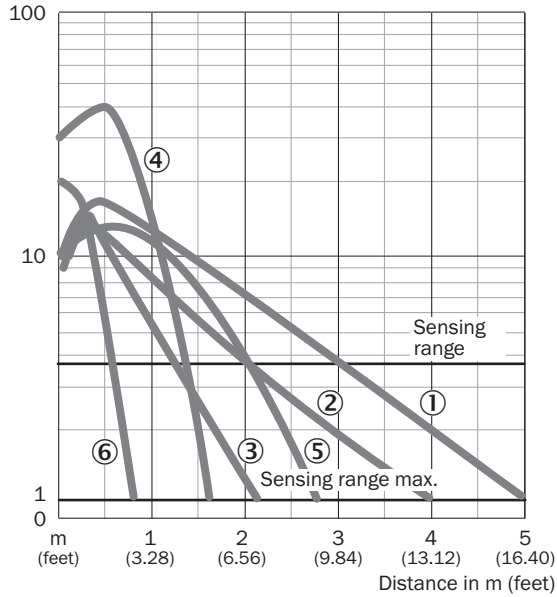

- ① Reflector PL80A
- ② Reflector PL40A
- ③ Reflector PL20A
- ④ PL10F reflector
- ⑤ Reflector P250 CHEM
- ⑥ Reflective tape REF-IRF-56

Sensing range diagram

WL4S-3, WLG4S-3, 5 m

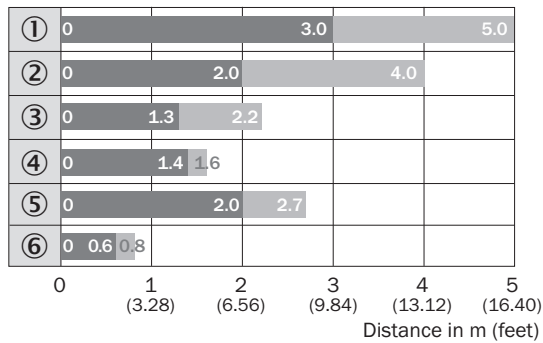

■ Sensing range ■ Sensing range max.

- ① Reflector PL80A
- ② Reflector PL40A
- ③ Reflector PL20A
- ④ PL10F reflector
- ⑤ Reflector P250 CHEM
- ⑥ Reflective tape REF-IRF-56

Dimensional drawing (Dimensions in mm (inch))

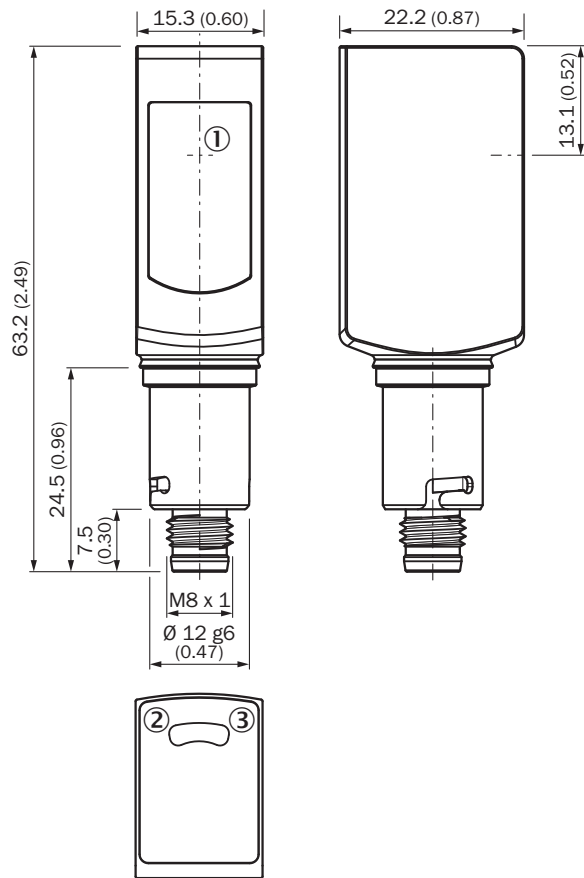

WL4S-3H, WLG4S-3H, without single teach-in button, D12 adapter shaft, I-adaption



- ① Center of optical axis
- ② LED indicator green: Supply voltage active
- ③ LED indicator yellow: Status of received light beam

Recommended accessories

Other models and accessories → www.sick.com/W4S-3_Inox_Hygiene_Glass

	Brief description	Type	Part no.
Other mounting accessories			
	Diameter 18 mm x 100 mm for W4S-3 Inox hygiene. Hygienic integration without holes and brackets. Cable run inside tube	BEF-MR18G-NA	4065853
Plug connectors and cables			
	Head A: female connector, M8, 4-pin, straight Head B: Flying leads Cable: Sensor/actuator cable, PVC, unshielded, 5 m This product is generally resistant to chemical cleaning agents (see ECOLAB). Please do not use cleaning agents of any other kind., Not resistant against lactic acid & hydrogen peroxide (H2O2)	DOL-0804-G05MNI	6059194

	Brief description	Type	Part no.
Reflectors			
	Chemically resistant, screw connection, 52 mm x 62 mm, plastic, Screw-on, 2 hole mounting	P250 CHEM	5321097

SICK AT A GLANCE

SICK is one of the leading manufacturers of intelligent sensors and sensor solutions for industrial applications. A unique range of products and services creates the perfect basis for controlling processes securely and efficiently, protecting individuals from accidents and preventing damage to the environment.

We have extensive experience in a wide range of industries and understand their processes and requirements. With intelligent sensors, we can deliver exactly what our customers need. In application centers in Europe, Asia and North America, system solutions are tested and optimized in accordance with customer specifications. All this makes us a reliable supplier and development partner.

Comprehensive services complete our offering: SICK LifeTime Services provide support throughout the machine life cycle and ensure safety and productivity.

For us, that is “Sensor Intelligence.”

WORLDWIDE PRESENCE:

Contacts and other locations –www.sick.com