



# WT24-2B220

W24-2

COMPACT PHOTOELECTRIC SENSORS

**SICK**  
Sensor Intelligence.



Illustration may differ



### Ordering information

Type	Part no.
WT24-2B220	1017882

Other models and accessories → [www.sick.com/W24-2](http://www.sick.com/W24-2)

### Detailed technical data

#### Features

<b>Device type</b>	Photoelectric sensors
<b>Sensor/ detection principle</b>	Photoelectric proximity sensor, Background suppression
<b>Dimensions (W x H x D)</b>	27 mm x 87.5 mm x 65 mm
<b>Housing design (light emission)</b>	Rectangular
<b>Sensing range max.</b>	100 mm ... 2,500 mm <sup>1)</sup>
<b>Sensing range</b>	100 mm ... 2,500 mm <sup>1)</sup>
<b>Type of light</b>	Infrared light
<b>Light source</b>	LED <sup>2)</sup>
<b>Light spot size (distance)</b>	Ø 80 mm (2,500 mm)
<b>Adjustment</b>	Potentiometer

<sup>1)</sup> Object with 90% remission (based on standard white, DIN 5033).

<sup>2)</sup> Average service life: 100,000 h at T<sub>J</sub> = +25 °C.

#### Mechanics/electronics

<b>Supply voltage</b>	10 V DC ... 30 V DC <sup>1)</sup>
<b>Ripple</b>	< 5 V <sub>pp</sub> <sup>2)</sup>
<b>Current consumption</b>	150 mA <sup>3)</sup>
<b>Switching output</b>	NPN

<sup>1)</sup> Limit values when operated in short-circuit protected network: max. 8 A.

<sup>2)</sup> May not exceed or fall below U<sub>V</sub> tolerances.

<sup>3)</sup> Without load.

<sup>4)</sup> Signal transit time with resistive load.

<sup>5)</sup> With light/dark ratio 1:1.

<sup>6)</sup> A = V<sub>S</sub> connections reverse-polarity protected.

<sup>7)</sup> C = interference suppression.

<sup>8)</sup> D = outputs overcurrent and short-circuit protected.

<sup>9)</sup> Reference voltage: 50 V DC.

<sup>10)</sup> Static, low heat output, use in +5 °C ... +15 °C.

	PNP
<b>Switching mode</b>	Light/dark switching
<b>Switching mode selector</b>	Selectable via PNP/NPN selector, selectable via light/dark selector
<b>Output current <math>I_{max}</math></b>	$\leq 100$ mA
<b>Response time</b>	$\leq 500$ $\mu$ s <sup>4)</sup>
<b>Switching frequency</b>	1,000 Hz <sup>5)</sup>
<b>Time functions</b>	On delay Off delay
<b>Delay time</b>	Adjustable via time delay selector switch, 0.5 s ... 10 s
<b>Connection type</b>	Terminal connection with M16 gland
<b>Circuit protection</b>	A <sup>6)</sup> C <sup>7)</sup> D <sup>8)</sup>
<b>Protection class</b>	II <sup>9)</sup>
<b>Weight</b>	330 g
<b>Front screen heating</b>	✓ <sup>10)</sup>
<b>Housing material</b>	Metal, zinc diecast
<b>Optics material</b>	Plastic, PMMA
<b>Enclosure rating</b>	IP67
<b>Test input sender off</b>	TE to 0 V
<b>Ambient operating temperature</b>	-40 °C ... +60 °C
<b>Ambient temperature, storage</b>	-40 °C ... +75 °C

1) Limit values when operated in short-circuit protected network: max. 8 A.

2) May not exceed or fall below  $U_v$  tolerances.

3) Without load.

4) Signal transit time with resistive load.

5) With light/dark ratio 1:1.

6) A =  $V_S$  connections reverse-polarity protected.

7) C = interference suppression.

8) D = outputs overcurrent and short-circuit protected.

9) Reference voltage: 50 V DC.

10) Static, low heat output, use in +5° C ... +15° C.

### Safety-related parameters

<b>MTTF<sub>D</sub></b>	550 years
<b>DC<sub>avg</sub></b>	0 %

### Classifications

<b>eCl@ss 5.0</b>	27270904
<b>eCl@ss 5.1.4</b>	27270904
<b>eCl@ss 6.0</b>	27270904
<b>eCl@ss 6.2</b>	27270904
<b>eCl@ss 7.0</b>	27270904
<b>eCl@ss 8.0</b>	27270904
<b>eCl@ss 8.1</b>	27270904
<b>eCl@ss 9.0</b>	27270904

<b>eCl@ss 10.0</b>	27270904
<b>eCl@ss 11.0</b>	27270904
<b>eCl@ss 12.0</b>	27270904
<b>ETIM 5.0</b>	EC002719
<b>ETIM 6.0</b>	EC002719
<b>ETIM 7.0</b>	EC002719
<b>ETIM 8.0</b>	EC002719
<b>UNSPSC 16.0901</b>	39121528

### Connection type

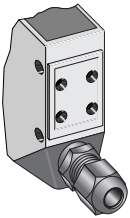

### Connection diagram

Cd-120

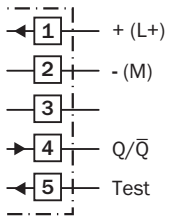

### Characteristic curve

WT24-2, infrared light

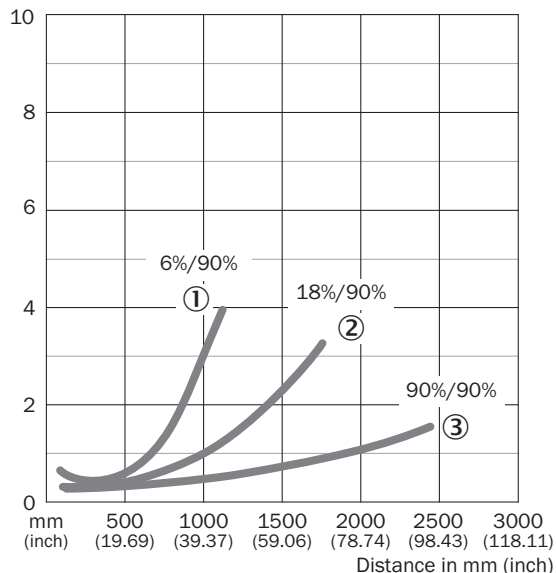

- ① Sensing range on black, 6% remission
- ② Sensing range on gray, 18 % remission
- ③ Sensing range on white, 90% remission

### Sensing range diagram

WT24-2, infrared light

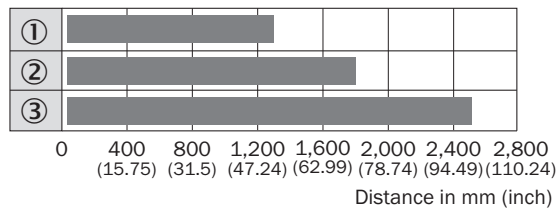

- Sensing range
- ① Sensing range on black, 6% remission
- ② Sensing range on gray, 18 % remission
- ③ Sensing range on white, 90% remission

Adjustments

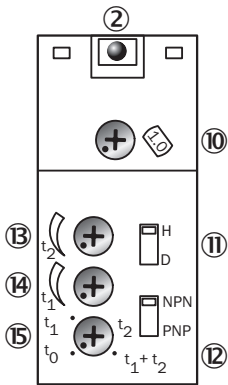

- ② LED signal strength indicator
- ⑩ Adjustment of sensing range
- ⑪ Light/dark selector
- ⑫ NPN/PNP changeover switch
- ⑬ Time control  $t_2$  = OFF delay
- ⑭ Time control  $t_1$  = ON delay
- ⑮ Time delay selector switch

Dimensional drawing (Dimensions in mm (inch))

WT24-2

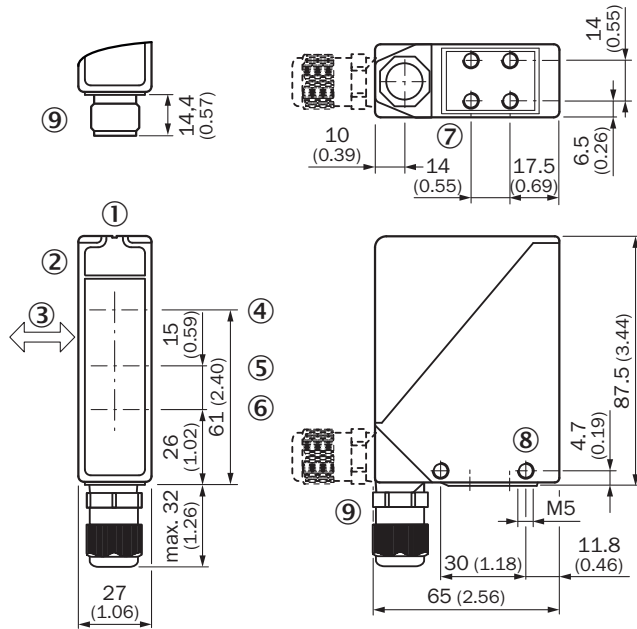

- ① Alignment sight
- ② LED signal strength indicator
- ③ Standard direction of the material being detected
- ④ Center of optical axis, sender
- ⑤ Center of optical axis, receiver (close range)
- ⑥ Center of optical axis, receiver (far range)
- ⑦ M5 threaded mounting hole, 6 mm deep
- ⑧ M5 threaded mounting hole, through-hole
- ⑨ M16 screw fixing and plug rotatable by 90°

Recommended accessories

Other models and accessories → [www.sick.com/W24-2](http://www.sick.com/W24-2)

	Brief description	Type	Part no.
Mounting brackets and plates			
	Mounting bracket, large, stainless steel, without mounting hardware for the sensor	BEF-WG-W24	4026324

## SICK AT A GLANCE

SICK is one of the leading manufacturers of intelligent sensors and sensor solutions for industrial applications. A unique range of products and services creates the perfect basis for controlling processes securely and efficiently, protecting individuals from accidents and preventing damage to the environment.

We have extensive experience in a wide range of industries and understand their processes and requirements. With intelligent sensors, we can deliver exactly what our customers need. In application centers in Europe, Asia and North America, system solutions are tested and optimized in accordance with customer specifications. All this makes us a reliable supplier and development partner.

Comprehensive services complete our offering: SICK LifeTime Services provide support throughout the machine life cycle and ensure safety and productivity.

For us, that is “Sensor Intelligence.”

## WORLDWIDE PRESENCE:

Contacts and other locations –[www.sick.com](http://www.sick.com)