

# IMG30-15BPSZU2S

IMG

INDUCTIVE PROXIMITY SENSORS

**SICK**  
Sensor Intelligence.

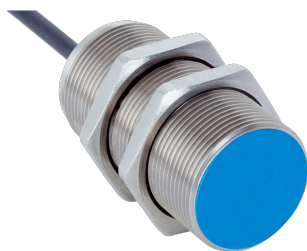

Illustration may differ



## Ordering information

Type	Part no.
IMG30-15BPSZU2S	1135616

**Included in delivery:** BEF-MU-M30 (1)

Other models and accessories → [www.sick.com/IMG](http://www.sick.com/IMG)

## Detailed technical data

### Features

<b>Housing</b>	Metric
<b>Housing</b>	Standard design
<b>Thread size</b>	M30 x 1.5
<b>Diameter</b>	Ø 30 mm
<b>Sensing range <math>S_n</math></b>	15 mm
<b>Safe sensing range <math>S_a</math></b>	12.15 mm
<b>Installation type</b>	Flush
<b>Switching frequency</b>	500 Hz
<b>Connection type</b>	Cable, 3-wire, 2 m
<b>Switching output</b>	PNP
<b>Switching output detail</b>	PNP
<b>Output function</b>	NO
<b>Electrical wiring</b>	DC 3-wire
<b>Enclosure rating</b>	IP67 <sup>1)</sup> IP68 <sup>1)</sup> IP69K <sup>2)</sup>
<b>Special features</b>	Resistant against coolant lubricants, Temperature resistance
<b>Special applications</b>	Zones with coolants and lubricants, Mobile machines, Difficult application conditions
<b>Items supplied</b>	Mounting nut, brass, nickel-plated (2x)

<sup>1)</sup> According to EN 60529.

<sup>2)</sup> According to ISO 20653:2013-03.

### Mechanics/electronics

<b>Supply voltage</b>	10 V DC ... 30 V DC
<b>Ripple</b>	≤ 10 %

<sup>1)</sup> At  $I_a$  max.

<sup>2)</sup> Supply voltage  $U_B$  and constant ambient temperature  $T_a$ .

<sup>3)</sup> Of  $S_r$ .

<b>Voltage drop</b>	$\leq 2 \text{ V}^{1)}$
<b>Time delay before availability</b>	$\leq 100 \text{ ms}$
<b>Hysteresis</b>	3 % ... 20 %
<b>Reproducibility</b>	$\leq 2 \%^{2) 3)}$
<b>Temperature drift (of S<sub>r</sub>)</b>	$\pm 10 \%$
<b>EMC</b>	According to EN 60947-5-2
<b>Environmental test</b>	Quick temperature change EN 60068-2-14, Na: TA = -25 °C, TB = 75 °C, t1 = 40 min, t2 = < 10 s, 300 cycles
<b>Corrosion test</b>	Salt spray test EN 60068-2-52: severity 5, 4 cycles
<b>Continuous current I<sub>a</sub></b>	$\leq 200 \text{ mA}$
<b>No load current</b>	$\leq 10 \text{ mA}$
<b>Cable material</b>	PUR
<b>Conductor size</b>	0.25 mm <sup>2</sup>
<b>Cable diameter</b>	Ø 3.9 mm
<b>Bending radius</b>	With fixed installation > 5 x cable diameter For flexible use > 10 x cable diameter
<b>Short-circuit protection</b>	✓
<b>Power-up pulse protection</b>	✓
<b>Shock and vibration resistance</b>	Vibration resistance acc. to EN 60068-2-6 Fc: 60 g peak (10 Hz ... 2,000 Hz) Long-term shock resistance acc. to EN 60068-2-27 Ea: 100 g 2 ms sinusoidal; 500 shocks in each direction of the 3 coordinate axes Broadband noise acc. to EN 60068-2-64: 15 g rms (5 Hz ... 2,000 Hz) / 8 hours in each direction of the 3 coordinate axes
<b>Indication</b>	LED yellow Switching status Permanently on: Switching output active
<b>Ambient operating temperature</b>	-40 °C ... +85 °C
<b>Housing material</b>	Nickel-plated brass
<b>Sensing face material</b>	Plastic, LCP
<b>Housing length</b>	60.7 mm
<b>Thread length</b>	56.2 mm
<b>Tightening torque, max.</b>	$\leq 70 \text{ Nm}$
<b>Protection class</b>	III
<b>UL File No.</b>	E181493

1) At I<sub>a</sub> max.

2) Supply voltage U<sub>B</sub> and constant ambient temperature T<sub>a</sub>.

3) Of S<sub>r</sub>.

### Safety-related parameters

<b>MTTF<sub>D</sub></b>	1,820 years
<b>DC<sub>avg</sub></b>	0 %
<b>T<sub>M</sub> (mission time)</b>	20 years

### Reduction factors

<b>Note</b>	The values are reference values which may vary
-------------	--

<b>St37 steel (Fe)</b>	1
<b>Stainless steel (V2A, 304)</b>	Approx. 0.72
<b>Aluminum (Al)</b>	Approx. 0.37
<b>Copper (Cu)</b>	Approx. 0.29
<b>Brass (Br)</b>	Approx. 0.39

Installation note

<b>Remark</b>	Associated graphic see "Installation"
<b>B</b>	40 mm
<b>C</b>	30 mm
<b>D</b>	45 mm
<b>F</b>	120 mm

Classifications

<b>ECLASS 5.0</b>	27270101
<b>ECLASS 5.1.4</b>	27270101
<b>ECLASS 6.0</b>	27270101
<b>ECLASS 6.2</b>	27270101
<b>ECLASS 7.0</b>	27270101
<b>ECLASS 8.0</b>	27270101
<b>ECLASS 8.1</b>	27270101
<b>ECLASS 9.0</b>	27270101
<b>ECLASS 10.0</b>	27270101
<b>ECLASS 11.0</b>	27270101
<b>ECLASS 12.0</b>	27274001
<b>ETIM 5.0</b>	EC002714
<b>ETIM 6.0</b>	EC002714
<b>ETIM 7.0</b>	EC002714
<b>ETIM 8.0</b>	EC002714
<b>UNSPSC 16.0901</b>	39122230

Installation note

Flush installation

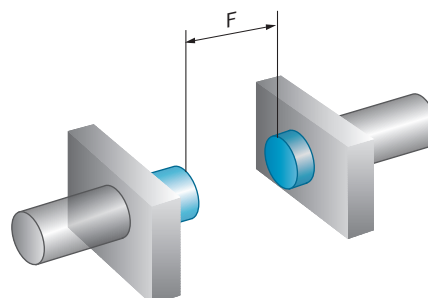
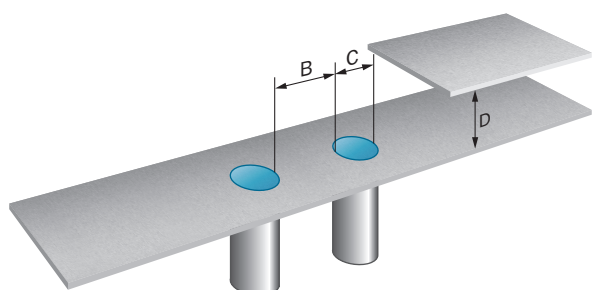

### Connection diagram

Cd-001

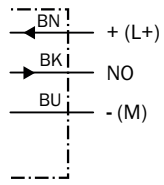

### Response diagram

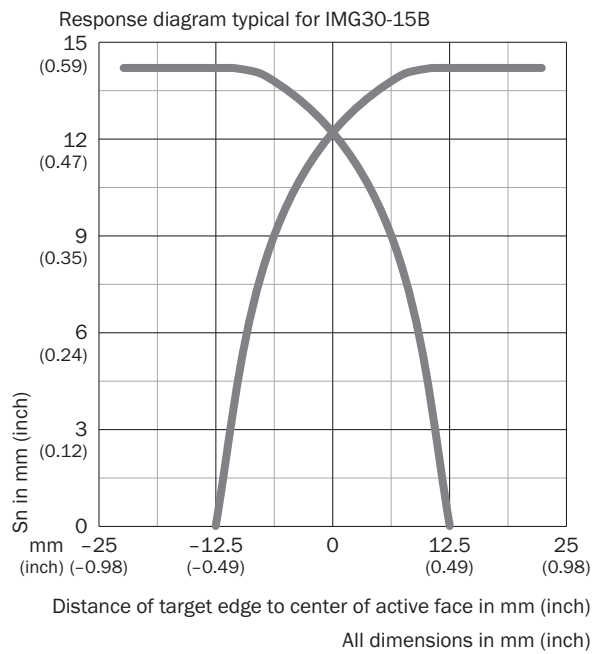

### Functional principle

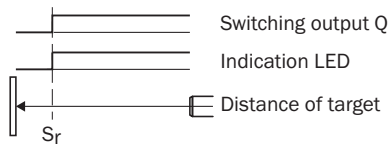

**Dimensional drawing** (Dimensions in mm (inch))



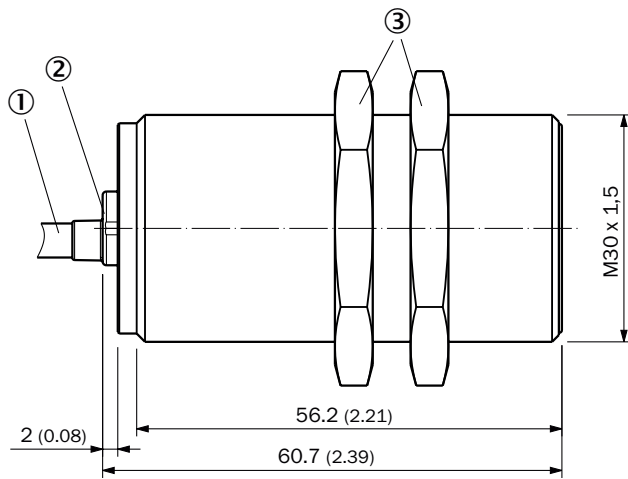

IMG30, standard variant, cable, flush



- ① Connection
- ② Display LED
- ③ Fastening nuts (2x); AF36; nickel-plated brass

**Recommended accessories**

Other models and accessories → [www.sick.com/IMG](http://www.sick.com/IMG)

	Brief description	Type	Part no.
<b>Mounting brackets and plates</b>			
	<ul style="list-style-type: none"> <li>• <b>Description:</b> Mounting plate for M30 sensors</li> <li>• <b>Material:</b> Steel</li> <li>• <b>Details:</b> Steel, zinc coated</li> <li>• <b>Items supplied:</b> Without mounting hardware</li> </ul>	BEF-WG-M30	5321871
	<ul style="list-style-type: none"> <li>• <b>Description:</b> Mounting bracket for M30 sensors</li> <li>• <b>Material:</b> Steel</li> <li>• <b>Details:</b> Steel, zinc coated</li> <li>• <b>Items supplied:</b> Without mounting hardware</li> </ul>	BEF-WN-M30	5308445
<b>Others</b>			
	<ul style="list-style-type: none"> <li>• <b>Connection type head A:</b> Female connector, M12, 4-pin, straight, A-coded</li> <li>• <b>Description:</b> Unshielded</li> <li>• <b>Connection systems:</b> Screw-type terminals</li> <li>• <b>Permitted cross-section:</b> ≤ 0.75 mm<sup>2</sup></li> <li>• <b>Application:</b> Hygienic and washdown zones</li> </ul>	DOS-1204-GN	6028357
	<ul style="list-style-type: none"> <li>• <b>Connection type head A:</b> Male connector, M12, 4-pin, straight, A-coded</li> <li>• <b>Description:</b> Unshielded</li> <li>• <b>Connection systems:</b> Screw-type terminals</li> <li>• <b>Permitted cross-section:</b> ≤ 0.75 mm<sup>2</sup></li> <li>• <b>Application:</b> Hygienic and washdown zones</li> </ul>	STE-1204-GN	6028359
	<ul style="list-style-type: none"> <li>• <b>Connection type head A:</b> Female connector, M12, 4-pin, angled, A-coded</li> <li>• <b>Description:</b> Unshielded</li> <li>• <b>Connection systems:</b> Screw-type terminals</li> <li>• <b>Permitted cross-section:</b> ≤ 0.75 mm<sup>2</sup></li> <li>• <b>Application:</b> Hygienic and washdown zones</li> </ul>	DOS-1204-WN	6028358

	Brief description	Type	Part no.
	<ul style="list-style-type: none"><li>• <b>Connection type head A:</b> Male connector, M12, 4-pin, straight, A-coded</li><li>• <b>Description:</b> Unshielded</li><li>• <b>Connection systems:</b> Screw-type terminals</li><li>• <b>Permitted cross-section:</b> ≤ 0.75 mm<sup>2</sup></li><li>• <b>Note:</b> For 2 cable connections</li><li>• <b>Application:</b> Hygienic and washdown zones</li></ul>	STE-1204-TN	6028360

## SICK AT A GLANCE

SICK is one of the leading manufacturers of intelligent sensors and sensor solutions for industrial applications. A unique range of products and services creates the perfect basis for controlling processes securely and efficiently, protecting individuals from accidents and preventing damage to the environment.

We have extensive experience in a wide range of industries and understand their processes and requirements. With intelligent sensors, we can deliver exactly what our customers need. In application centers in Europe, Asia and North America, system solutions are tested and optimized in accordance with customer specifications. All this makes us a reliable supplier and development partner.

Comprehensive services complete our offering: SICK LifeTime Services provide support throughout the machine life cycle and ensure safety and productivity.

For us, that is “Sensor Intelligence.”

## WORLDWIDE PRESENCE:

Contacts and other locations –[www.sick.com](http://www.sick.com)