



UC30-215163

UC30

ULTRASONIC SENSORS

**SICK**  
Sensor Intelligence.



### Ordering information

| Type        | Part no. |
|-------------|----------|
| UC30-215163 | 6054716  |

Other models and accessories → [www.sick.com/UC30](http://www.sick.com/UC30)



### Detailed technical data

#### Mechanics/electronics

|  |  |
|--|--|
| <b>Supply voltage <math>V_s</math></b> | DC 9 V ... 30 V <sup>1) 2)</sup>   |
| <b>Power consumption</b>               | ≤ 1.2 W <sup>3)</sup>  |
| <b>Initialization time</b>             | < 450 ms <sup>4)</sup>   |
| <b>Design</b>                          | Rectangular  |
| <b>Housing material</b>                | Plastic (PBT/PET)<br>Ultrasonic transducer: polyurethane foam, glass epoxy resin |
| <b>Connection type</b>                 | Male connector, M12, 5-pin   |
| <b>Indication</b>                      | 2 x LED  |
| <b>Weight</b>                          | 240 g  |
| <b>Sending axis</b>                    | Straight   |
| <b>Dimensions (W x H x D)</b>          | 62.2 mm x 62.2 mm x 36.7 mm  |
| <b>Enclosure rating</b>                | IP65 / IP67  |
| <b>Protection class</b>                | III  |

<sup>1)</sup> Limit values, reverse-polarity protected Operation in short-circuit protected network: max. 8 A, class 2.

<sup>2)</sup> 15 V ... 30 V when using the analog voltage output.

<sup>3)</sup> Without load.

<sup>4)</sup> Subsequent smoothing of the analog output, depending on the application, may increase the initialization time by up to 200 %.

#### Performance

|  |                               |
|--|-------------------------------|
| <b>Operating range, limiting range</b> | 600 mm ... 6,000 mm, 8,000 mm |
| <b>Target</b>                          | Natural objects               |
| <b>Resolution</b>                      | ≥ 0.18 mm                     |
| <b>Repeatability</b>                   | ± 0.15 % <sup>1)</sup>        |
| <b>Accuracy</b>                        | ± 1 % <sup>2) 3)</sup>        |
| <b>Temperature compensation</b>        | ✓                             |

<sup>1)</sup> In relation to the current measured value, minimum value ≥ resolution.

<sup>2)</sup> Referring to current measurement value.

<sup>3)</sup> Temperature compensation can be switched off, without temperature compensation: 0.17 % / K.

<sup>4)</sup> Subsequent smoothing of the analog output, depending on the application, may increase the response time by up to 200 %.

|                                       |   |
|---------------------------------------|---|
| <b>Response time</b>                  | 240 ms <sup>4)</sup>  |
| <b>Output time</b>                    | 60 ms   |
| <b>Ultrasonic frequency (typical)</b> | 80 kHz  |
| <b>Detection area (typical)</b>       | See diagrams  |
| <b>Additional function</b>            | Teach-in of analog output, scaling of analog outputs, Invertable analog output, synchronization of up to 50 sensors, multiplexing: no cross talk of up to 50 sensors, adjustable measurement filters: Measured value filters/Filter strength/Foreground suppression/Detection area/Sensitivity and sound beam, reset to factory default |

<sup>1)</sup> In relation to the current measured value, minimum value  $\geq$  resolution.

<sup>2)</sup> Referring to current measurement value.

<sup>3)</sup> Temperature compensation can be switched off, without temperature compensation: 0.17 % / K.

<sup>4)</sup> Subsequent smoothing of the analog output, depending on the application, may increase the response time by up to 200 %.

## Interfaces

|                                   |   |
|-----------------------------------|---|
| <b>Analog output</b>              |   |
| Number                            | 1   |
| Type                              | Current output / voltage output   |
| Function                          | Automatic selection of analog current or voltage output dependent on load |
| Current                           | 4 mA ... 20 mA, $\leq 500 \Omega$ <sup>1)</sup>                           |
| Voltage                           | 0 V ... 10 V, $\geq 100,000 \Omega$                                       |
| Resolution                        | 12 bit  |
| <b>Multifunctional input (MF)</b> | 1 x MF  |

<sup>1)</sup> For 4 mA ... 20 mA and  $V_s \leq 20$  V max. load  $\leq 100 \Omega$ .

## Ambient data

|                                       |                   |
|---------------------------------------|-------------------|
| <b>Ambient temperature, operation</b> | -25 °C ... +70 °C |
| <b>Ambient temperature, storage</b>   | -40 °C ... +85 °C |

## Classifications

|                       |          |
|-----------------------|----------|
| <b>ECl@ss 5.0</b>     | 27270804 |
| <b>ECl@ss 5.1.4</b>   | 27270804 |
| <b>ECl@ss 6.0</b>     | 27270804 |
| <b>ECl@ss 6.2</b>     | 27270804 |
| <b>ECl@ss 7.0</b>     | 27270804 |
| <b>ECl@ss 8.0</b>     | 27270804 |
| <b>ECl@ss 8.1</b>     | 27270804 |
| <b>ECl@ss 9.0</b>     | 27270804 |
| <b>ECl@ss 10.0</b>    | 27270804 |
| <b>ECl@ss 11.0</b>    | 27270804 |
| <b>ECl@ss 12.0</b>    | 27272806 |
| <b>ETIM 5.0</b>       | EC001846 |
| <b>ETIM 6.0</b>       | EC001846 |
| <b>ETIM 7.0</b>       | EC001846 |
| <b>ETIM 8.0</b>       | EC001846 |
| <b>UNSPSC 16.0901</b> | 41111960 |

### Dimensional drawing (Dimensions in mm (inch))

UC30-215

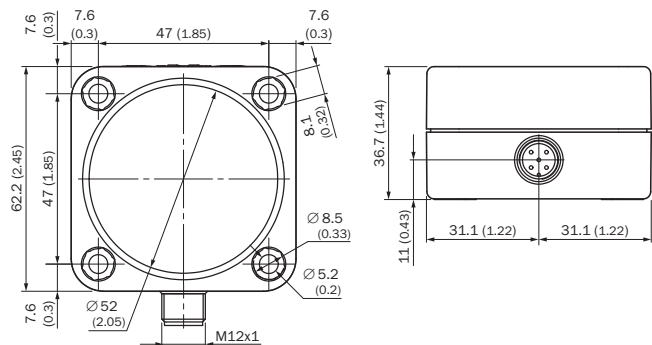

### Connection type

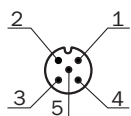

### Connection diagram

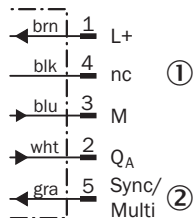

### Adjustment possible



- ① Control elements
- ② LED status indicator

## Detection area

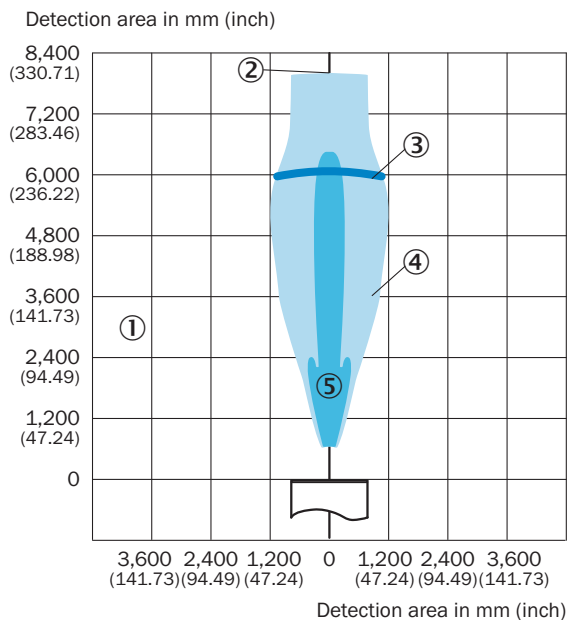

UM30-215, UC30-215



- ① Detection range dependent on reflection properties, size, and alignment of the object
- ② Limiting range
- ③ Operating range
- ④ Example object: aligned plate 500 mm x 500 mm
- ⑤ Example object: pipe with 27 mm diameter

## Recommended accessories

Other models and accessories → [www.sick.com/UC30](http://www.sick.com/UC30)

|   | Brief description   | Type                   | Part no. |
|---|---|------------------------|----------|
| <b>Programming and configuration tools</b>  |   |                        |          |
|  | Tool for visualization, configuration and cloning, 3-digit LED display, supply voltage: DV 9 V ... 30 V                               | Connect+ adapter (CPA) | 6037782  |
| <b>Universal bar clamp systems</b>  |   |                        |          |
|  | Plate K for universal clamp bracket, steel, zinc coated, Universal clamp (2022726), mounting hardware                                 | BEF-KHS-K01            | 2022718  |
| <b>Plug connectors and cables</b>   |   |                        |          |
|  | Head A: female connector, M12, 5-pin, straight, A-coded<br>Head B: Flying leads<br>Cable: Sensor/actuator cable, PVC, unshielded, 2 m | YF2A15-020VB5XLEAX     | 2096239  |

### Recommended services

Additional services → [www.sick.com/UC30](http://www.sick.com/UC30)

|  | Type   | Part no. |
|--|--|----------|
| Warranty extensions  |  |          |
| <ul style="list-style-type: none"><li>• <b>Product area:</b> Identification solutions, machine vision, Distance sensors, Detection and ranging solutions</li><li>• <b>Range of services:</b> The services correspond to the scope of the statutory manufacturer warranty (SICK general terms and conditions of purchase)</li><li>• <b>Duration:</b> Five-year warranty from delivery date.</li></ul> | Extended warranty for a total of five years from delivery date | 1680671  |

## SICK AT A GLANCE

SICK is one of the leading manufacturers of intelligent sensors and sensor solutions for industrial applications. A unique range of products and services creates the perfect basis for controlling processes securely and efficiently, protecting individuals from accidents and preventing damage to the environment.

We have extensive experience in a wide range of industries and understand their processes and requirements. With intelligent sensors, we can deliver exactly what our customers need. In application centers in Europe, Asia and North America, system solutions are tested and optimized in accordance with customer specifications. All this makes us a reliable supplier and development partner.

Comprehensive services complete our offering: SICK LifeTime Services provide support throughout the machine life cycle and ensure safety and productivity.

For us, that is “Sensor Intelligence.”

## WORLDWIDE PRESENCE:

Contacts and other locations –[www.sick.com](http://www.sick.com)