



# WTB4S-3P5262H

W4S-3 Inox Hygiene

MINIATURE PHOTOELECTRIC SENSORS

**SICK**  
Sensor Intelligence.



### Ordering information

Type	Part no.
WTB4S-3P5262H	1099888

Other models and accessories → [www.sick.com/W4S-3\\_Inox\\_Hygiene](http://www.sick.com/W4S-3_Inox_Hygiene)

Illustration may differ



### Detailed technical data

#### Features

<b>Sensor/ detection principle</b>	Photoelectric proximity sensor, Background suppression
<b>Dimensions (W x H x D)</b>	15.25 mm x 63.2 mm x 22.15 mm
<b>Housing design</b>	Hygiene
<b>Housing design (light emission)</b>	Rectangular
<b>Sensing range max.</b>	4 mm ... 500 mm <sup>1)</sup>
<b>Sensing range</b>	10 mm ... 350 mm <sup>1)</sup>
<b>Type of light</b>	Visible red light
<b>Light source</b>	PinPoint LED <sup>2)</sup>
<b>Light spot size (distance)</b>	Ø 6.5 mm (150 mm)
<b>Wave length</b>	650 nm
<b>Adjustment</b>	Single teach-in button
<b>Special applications</b>	Hygienic and washdown zones

<sup>1)</sup> Object with 90 % reflectance (referred to standard white, DIN 5033).

<sup>2)</sup> Average service life: 100,000 h at T<sub>U</sub> = +25 °C.

## Mechanics/electronics

<b>Supply voltage</b>	10 V DC ... 30 V DC <sup>1)</sup>
<b>Ripple</b>	< 5 V <sub>pp</sub> <sup>2)</sup>
<b>Current consumption</b>	30 mA <sup>3)</sup>
<b>Switching output</b>	PNP
<b>Output function</b>	Complementary
<b>Switching mode</b>	Light/dark switching
<b>Output current I<sub>max.</sub></b>	≤ 100 mA
<b>Response time</b>	< 0.5 ms <sup>4)</sup>
<b>Switching frequency</b>	1,000 Hz <sup>5)</sup>
<b>Connection type</b>	Male connector M8, 4-pin <sup>6)</sup>
<b>Mechanical connection</b>	D12 adapter shaft
<b>Circuit protection</b>	A <sup>7)</sup> B <sup>8)</sup> C <sup>9)</sup>
<b>Protection class</b>	III
<b>Weight</b>	140 g
<b>Housing material</b>	Stainless steel, Stainless steel V4A (1.4404, 316L)
<b>Optics material</b>	Plastic, PMMA
<b>Enclosure rating</b>	IP66 IP67 IP68 IP69K
<b>Special feature</b>	D12 adapter shaft
<b>Ambient operating temperature</b>	-30 °C ... +70 °C <sup>10)</sup> -30 °C ... +60 °C
<b>Ambient temperature, storage</b>	-30 °C ... +75 °C
<b>UL File No.</b>	FDA, UL No. NRKH.E181493 & cUL No. NRKH7.E181493

<sup>1)</sup> Limit values, reverse-polarity protected, operation in short-circuit protected network: max. 8 A.

<sup>2)</sup> May not exceed or fall below U<sub>v</sub> tolerances.

<sup>3)</sup> Without load.

<sup>4)</sup> Signal transit time with resistive load.

<sup>5)</sup> With light/dark ratio 1:1.

<sup>6)</sup> Max. tightening torque: 0.6 Nm.

<sup>7)</sup> A = V<sub>S</sub> connections reverse-polarity protected.

<sup>8)</sup> B = inputs and output reverse-polarity protected.

<sup>9)</sup> C = interference suppression.

<sup>10)</sup> At U<sub>V</sub> ≤ 24 V and I<sub>A</sub> < 30 mA.

## Classifications

<b>ECl@ss 5.0</b>	27270904
<b>ECl@ss 5.1.4</b>	27270904
<b>ECl@ss 6.0</b>	27270904
<b>ECl@ss 6.2</b>	27270904
<b>ECl@ss 7.0</b>	27270904
<b>ECl@ss 8.0</b>	27270904

<b>ECl@ss 8.1</b>	27270904
<b>ECl@ss 9.0</b>	27270904
<b>ECl@ss 10.0</b>	27270904
<b>ECl@ss 11.0</b>	27270904
<b>ETIM 5.0</b>	EC002719
<b>ETIM 6.0</b>	EC002719
<b>ETIM 7.0</b>	EC002719
<b>ETIM 8.0</b>	EC002719
<b>UNSPSC 16.0901</b>	39121528

### Connection diagram

Cd-083

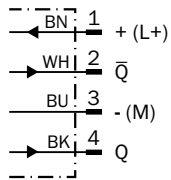

### Characteristic curve

WTB4S-3, 500 mm

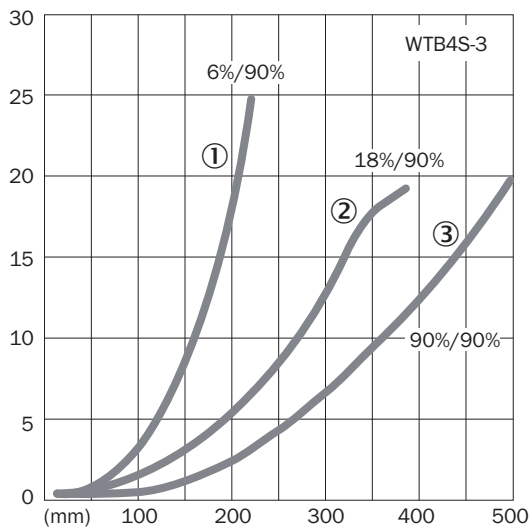

- ① Sensing range on black, 6% remission
- ② Sensing range on gray, 18 % remission
- ③ Sensing range on white, 90% remission

### Sensing range diagram

WTB4S-3, 500 mm

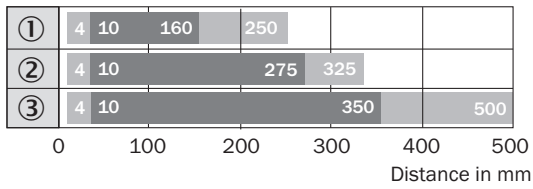

■ Sensing range      ■ Sensing range max.

- ① Sensing range on black, 6% remission
- ② Sensing range on gray, 18 % remission
- ③ Sensing range on white, 90% remission

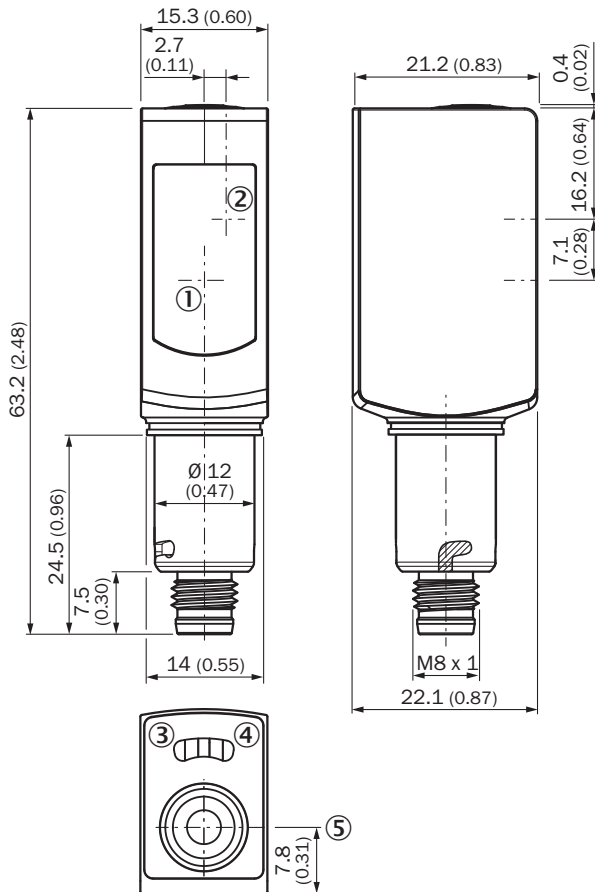

### Dimensional drawing (Dimensions in mm (inch))



- ① Center of optical axis, receiver
- ② Center of optical axis, sender
- ③ LED indicator yellow: Status of received light beam
- ④ LED indicator green: Supply voltage active
- ⑤ Single teach-in button

### Recommended accessories

Other models and accessories → [www.sick.com/W4S-3\\_Inox\\_Hygiene](http://www.sick.com/W4S-3_Inox_Hygiene)

	Brief description	Type	Part no.
Other mounting accessories			
	Diameter 18 mm x 100 mm for W4S-3 Inox hygiene. Hygienic integration without holes and brackets. Cable run inside tube	BEF-MR18G-NA	4065853
Plug connectors and cables			
	Head A: female connector, M8, 4-pin, straight, A-coded Head B: Flying leads Cable: Sensor/actuator cable, PVC, unshielded, 5 m	YF8U14-050VA3XLEAX	2095889
	Head A: male connector, M8, 4-pin, straight Head B: - Cable: unshielded	STE-0804-G	6037323

## SICK AT A GLANCE

SICK is one of the leading manufacturers of intelligent sensors and sensor solutions for industrial applications. A unique range of products and services creates the perfect basis for controlling processes securely and efficiently, protecting individuals from accidents and preventing damage to the environment.

We have extensive experience in a wide range of industries and understand their processes and requirements. With intelligent sensors, we can deliver exactly what our customers need. In application centers in Europe, Asia and North America, system solutions are tested and optimized in accordance with customer specifications. All this makes us a reliable supplier and development partner.

Comprehensive services complete our offering: SICK LifeTime Services provide support throughout the machine life cycle and ensure safety and productivity.

For us, that is “Sensor Intelligence.”

## WORLDWIDE PRESENCE:

Contacts and other locations –[www.sick.com](http://www.sick.com)