



UP56-213128

UP56

LEVEL SENSORS

SICK
Sensor Intelligence.



Illustration may differ



Ordering information

Type	Part no.
UP56-213128	6048702

Other models and accessories → www.sick.com/UP56

Detailed technical data

Features

Medium	Fluids, bulk solids
Measurement	Switch, Continuous
Measuring range in tank	200 mm ... 1,300 mm
Measuring range immersion tube	200 mm ... 5,000 mm
Process pressure	0 bar ... 6 bar
Process temperature	-25 °C ... +70 °C

Performance

Accuracy of sensor element	≤ 2 % ¹⁾
Reproducibility	± 0.15 % ¹⁾
Resolution	≤ 0.18 mm
Response time	≤ 180 ms ²⁾
MTTF	< 100 years

¹⁾ From the full scale value.

²⁾ Recovery time 32 ms ... 180 ms according to EMC EN 60947-5-7.

Electronics

Supply voltage	9 V DC ... 30 V DC ¹⁾
Residual ripple	± 10 %
Power consumption	≤ 80 mA ²⁾
Connection type	Round connector M12 x 1, 5-pin
Output signal	³⁾ 1 x PNP + 4 mA ... 20 mA / 0 V ... 10 V
Hysteresis	20 mm
Signal voltage HIGH	U _v - 3 V

¹⁾ Reverse-polarity protected.

²⁾ At 24 V DC without output load.

³⁾ Automatic switching between voltage and current outputs dependet on load 4 mA ... 20 mA: RL ≤ 100 / at 9 V ≤ U_B ≤ 20 V; RL ≤ 500/ at U_B ≥ 20 V; 0 V ... 10 V: RL ≥ 100 k/ at U_B ≥ 15 V, short-circuit protected.

Time delay before availability	≤ 300 ms
Enclosure rating	IP67
Ultrasonic frequency	180 kHz
Ultrasonic transducer	PTFE coating, FFKM

1) Reverse-polarity protected.

2) At 24 V DC without output load.

3) Automatic switching between voltage and current outputs dependet on load 4 mA ... 20 mA: RL ≤ 100 / at 9 V ≤ U_B ≤ 20 V; RL ≤ 500/ at U_B ≥ 20 V; 0 V ... 10 V: RL ≥ 100 k / at U_B ≥ 15 V, short-circuit protected.

Mechanics

Process connection	G 1 A
Housing material	Stainless steel 1.4571
Weight	350 g

Ambient data

Ambient operating temperature	-25 °C ... +70 °C ¹⁾
Ambient storage temperature	-40 °C ... +85 °C

1) Temperature compensation at -25 °C ... +50 °C, can be switched off.

Classifications

ECl@ss 5.0	27200506
ECl@ss 5.1.4	27200506
ECl@ss 6.0	27200506
ECl@ss 6.2	27200506
ECl@ss 7.0	27200506
ECl@ss 8.0	27200506
ECl@ss 8.1	27200506
ECl@ss 9.0	27200506
ECl@ss 10.0	27200506
ECl@ss 11.0	27200506
ETIM 5.0	EC001447
ETIM 6.0	EC001447
ETIM 7.0	EC001447
UNSPSC 16.0901	41111950

Type code

Type code

Coverage

1	30 mm ... 250 mm
2	85 mm ... 350 mm
3	200 mm ... 1,300 mm
4	350 mm ... 3,400 mm

Connectivity

1	M12 round connector x 1, 5-pin
2	M12 round connector x 1, 4-pin

Process connection / Housing

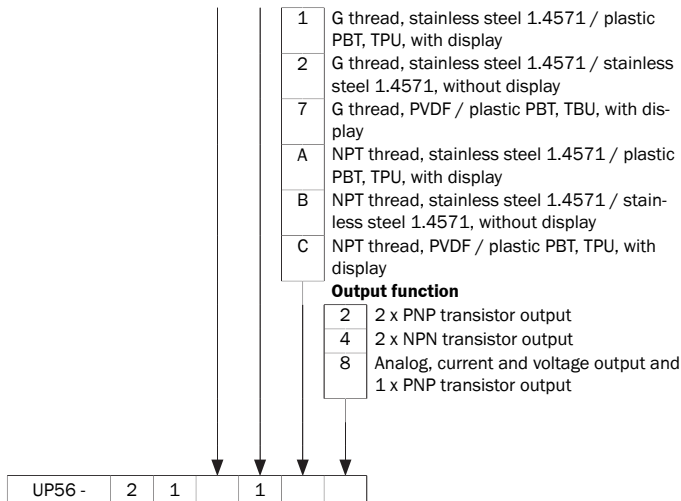

Not all variants of the type code can be combined!

[Dimensional drawing](#) (Dimensions in mm (inch))

UP56-211/ 212/ 213 all-metal

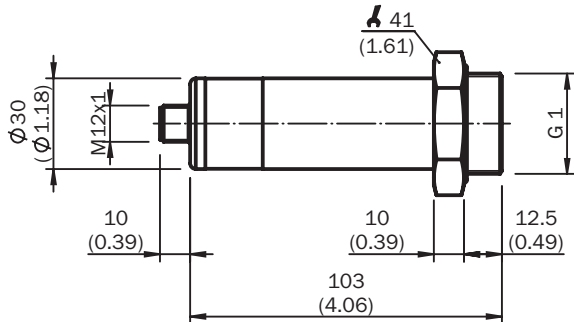

Connection diagram

1 x PNP + 4 mA ... 20 mA / 0 V ... 10 V

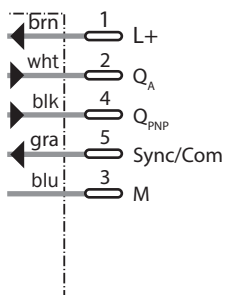

Connection type

Male connector M12, 5-pin



Scanning range

Detection range UP56-213118

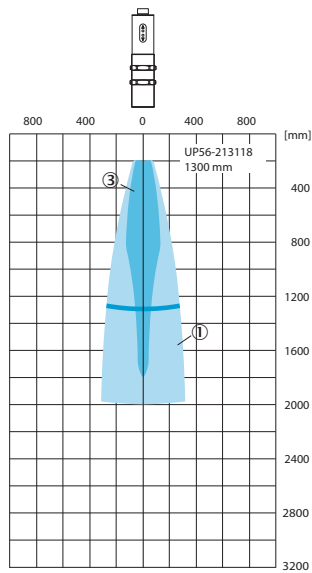















If the points named above are located in the radiation cone, reliable detection is guaranteed

- ① Example object: aligned plate 500 mm x 500 mm
- ③ Pipe diameter 27 mm

Recommended accessories

Other models and accessories → www.sick.com/UP56

	Brief description	Type	Part no.
Flanges			
	Welded flange, process connection G 1, Stainless steel 1.4404	BEF-FL-316G10-UP56	4064295
	Welded flange/welded connector, process connection G 2, Stainless steel 1.4404	BEF-FL-316G20-UP56	4063263
Plug connectors and cables			
	Head A: female connector, M12, 5-pin, straight, A-coded Head B: Flying leads Cable: Sensor/actuator cable, PUR, halogen-free, unshielded, 2 m	YF2A15-020UB5XLEAX	2095617
	Head A: female connector, M12, 5-pin, straight, A-coded Head B: Flying leads Cable: Sensor/actuator cable, PVC, unshielded, 2 m	YF2A15-020VB5XLEAX	2096239
	Head A: female connector, M12, 5-pin, straight, A-coded Head B: Flying leads Cable: Sensor/actuator cable, PUR, halogen-free, unshielded, 5 m	YF2A15-050UB5XLEAX	2095618
	Head A: female connector, M12, 5-pin, straight, A-coded Head B: Flying leads Cable: Sensor/actuator cable, PVC, unshielded, 5 m	YF2A15-050VB5XLEAX	2096240

	Brief description	Type	Part no.
	Head A: female connector, M12, 5-pin, straight, A-coded Head B: Flying leads Cable: Sensor/actuator cable, PUR, halogen-free, unshielded, 10 m	YF2A15-100UB5XLEAX	2095619
	Head A: female connector, M12, 5-pin, straight, A-coded Head B: Flying leads Cable: Sensor/actuator cable, PVC, unshielded, 10 m	YF2A15-100VB5XLEAX	2096241
	Head A: female connector, M12, 5-pin, angled, A-coded Head B: Flying leads Cable: Sensor/actuator cable, PUR, halogen-free, unshielded, 2 m	YG2A15-020UB5XLEAX	2095772
	Head A: female connector, M12, 5-pin, angled, A-coded Head B: Flying leads Cable: Sensor/actuator cable, PVC, unshielded, 2 m	YG2A15-020VB5XLEAX	2096215
	Head A: female connector, M12, 5-pin, angled, A-coded Head B: Flying leads Cable: Sensor/actuator cable, PUR, halogen-free, unshielded, 5 m	YG2A15-050UB5XLEAX	2095773
	Head A: female connector, M12, 5-pin, angled, A-coded Head B: Flying leads Cable: Sensor/actuator cable, PVC, unshielded, 5 m	YG2A15-050VB5XLEAX	2096216
	Head A: female connector, M12, 5-pin, angled, A-coded Head B: Flying leads Cable: Sensor/actuator cable, PUR, halogen-free, unshielded, 10 m	YG2A15-100UB5XLEAX	2095774
	Head A: female connector, M12, 5-pin, angled, A-coded Head B: Flying leads Cable: Sensor/actuator cable, PVC, unshielded, 10 m	YG2A15-100VB5XLEAX	2096217
Programming and configuration tools			
	Tool for visualization, configuration and cloning, 3-digit LED display, supply voltage: DV 9 V ... 30 V	Connect+ adapter (CPA)	6037782

SICK AT A GLANCE

SICK is one of the leading manufacturers of intelligent sensors and sensor solutions for industrial applications. A unique range of products and services creates the perfect basis for controlling processes securely and efficiently, protecting individuals from accidents and preventing damage to the environment.

We have extensive experience in a wide range of industries and understand their processes and requirements. With intelligent sensors, we can deliver exactly what our customers need. In application centers in Europe, Asia and North America, system solutions are tested and optimized in accordance with customer specifications. All this makes us a reliable supplier and development partner.

Comprehensive services complete our offering: SICK LifeTime Services provide support throughout the machine life cycle and ensure safety and productivity.

For us, that is “Sensor Intelligence.”

WORLDWIDE PRESENCE:

Contacts and other locations –www.sick.com