



AFM60A-BBIB018x12

AFS/AFM60 Ethernet

ABSOLUTE ENCODERS

SICK
Sensor Intelligence.



Illustration may differ



Ordering information

| Type | Part no. |
|-------------------|----------|
| AFM60A-BBIB018x12 | 1077495 |

Other models and accessories → www.sick.com/AFS_AFM60_Ethernet

Detailed technical data

Performance

| | |
|---|-----------------------------------|
| Number of steps per revolution (max. resolution) | 262,144 (18 bit) |
| Number of revolutions | 4,096 (12 bit) |
| Max. resolution (number of steps per revolution x number of revolutions) | 18 bit x 12 bit (262,144 x 4,096) |
| Error limits G | 0.03° ¹⁾ |
| Repeatability standard deviation σ_r | 0.002° ²⁾ |

¹⁾ In accordance with DIN ISO 1319-1, position of the upper and lower error limit depends on the installation situation, specified value refers to a symmetrical position, i.e. deviation in upper and lower direction is the same.

²⁾ In accordance with DIN ISO 55350-13; 68.3% of the measured values are inside the specified area.

Interfaces

| | |
|---|--|
| Communication interface | EtherNet/IP™ |
| Encoder profile | 0 x 22 |
| Data transmission rate (baud rate) | 10 Mbit/s 100 Mbit/s |
| Transmission medium | CAT-5e cable |
| Initialization time | Approx. 10 s |
| RPI (requested packet interval) | 5 ms ... 750 ms |
| Parameterising data | Number of steps per revolution Number of revolutions PRESET Counting direction Sampling rate for speed calculation Unit for output of speed, acceleration and temperature value Output of scalable limit values such as: position ranges, speed, acceleration, start-up of the CW/CCW directions of rotation, change of direction of rotation, operating hours and hours of shaft movement (motion) Round axis functionality Heartbeat |
| Available diagnostics data | Minimum and maximum temperature Maximum speed Power-on counter Operating hours counter power-on/motion Counter of direction changes/number of movements cw/number of movements ccw Number of changes of direction Minimum and maximum operating voltage |

| | |
|--------------------------------|--|
| | Signal monitoring for singleturn and multiturn |
| DLR (Device Level Ring) | ✓ |

Electrical data

| | |
|--|--|
| Connection type | Male connector, 1x, M12, 4-pin, axial ¹⁾ Female connector, 2x, M12, 4-pin, axial ²⁾ |
| Supply voltage | 10 ... 30 V |
| Power consumption | ≤ 3 W (without load) |
| Reverse polarity protection | ✓ |
| MTTFd: mean time to dangerous failure | 80 years (EN ISO 13849-1) ³⁾ |

¹⁾ A-coded.

²⁾ D-coded.

³⁾ This product is a standard product and does not constitute a safety component as defined in the Machinery Directive. Calculation based on nominal load of components, average ambient temperature 40 °C, frequency of use 8760 h/a. All electronic failures are considered hazardous. For more information, see document no. 8015532.

Mechanical data

| | |
|---------------------------------------|---|
| Mechanical design | Blind hollow shaft |
| Shaft diameter | 8 mm |
| Weight | 0.2 kg |
| Shaft material | Stainless steel |
| Flange material | Aluminum |
| Housing material | Aluminum |
| Start up torque | 0.8 Ncm (+20 °C) |
| Operating torque | 0.6 Ncm (+20 °C) |
| Permissible movement static | ± 0.3 mm (radial) ± 0.5 mm (axial) |
| Permissible movement dynamic | ± 0.05 mm (radial) ± 0.1 mm (axial) |
| Operating speed | ≤ 6,000 min ⁻¹ ¹⁾ |
| Moment of inertia of the rotor | 40 gcm ² |
| Bearing lifetime | 3 x 10 ⁹ revolutions |
| Angular acceleration | ≤ 500,000 rad/s ² |

¹⁾ Allow for self-heating of 3.3 K per 1,000 rpm when designing the operating temperature range.

Ambient data

| | |
|--------------------------------------|--|
| EMC | According to EN 61000-6-2 and EN 61000-6-3 |
| Enclosure rating | IP65, shaft side (IEC 60529) IP67, housing side (IEC 60529) ¹⁾ |
| Permissible relative humidity | 90 % (Condensation not permitted) |
| Operating temperature range | -40 °C ... +85 °C |
| Storage temperature range | -40 °C ... +100 °C, without package |
| Resistance to shocks | 100 g, 6 ms (EN 60068-2-27) |
| Resistance to vibration | 30 g, 10 Hz ... 2,000 Hz (EN 60068-2-6) |

¹⁾ With mating connector fitted.

Classifications

| | |
|-----------------------|----------|
| eCl@ss 5.0 | 27270502 |
| eCl@ss 5.1.4 | 27270502 |
| eCl@ss 6.0 | 27270590 |
| eCl@ss 6.2 | 27270590 |
| eCl@ss 7.0 | 27270502 |
| eCl@ss 8.0 | 27270502 |
| eCl@ss 8.1 | 27270502 |
| eCl@ss 9.0 | 27270502 |
| eCl@ss 10.0 | 27270502 |
| eCl@ss 11.0 | 27270502 |
| eCl@ss 12.0 | 27270502 |
| ETIM 5.0 | EC001486 |
| ETIM 6.0 | EC001486 |
| ETIM 7.0 | EC001486 |
| ETIM 8.0 | EC001486 |
| UNSPSC 16.0901 | 41112113 |

Dimensional drawing (Dimensions in mm (inch))

Blind hollow shaft

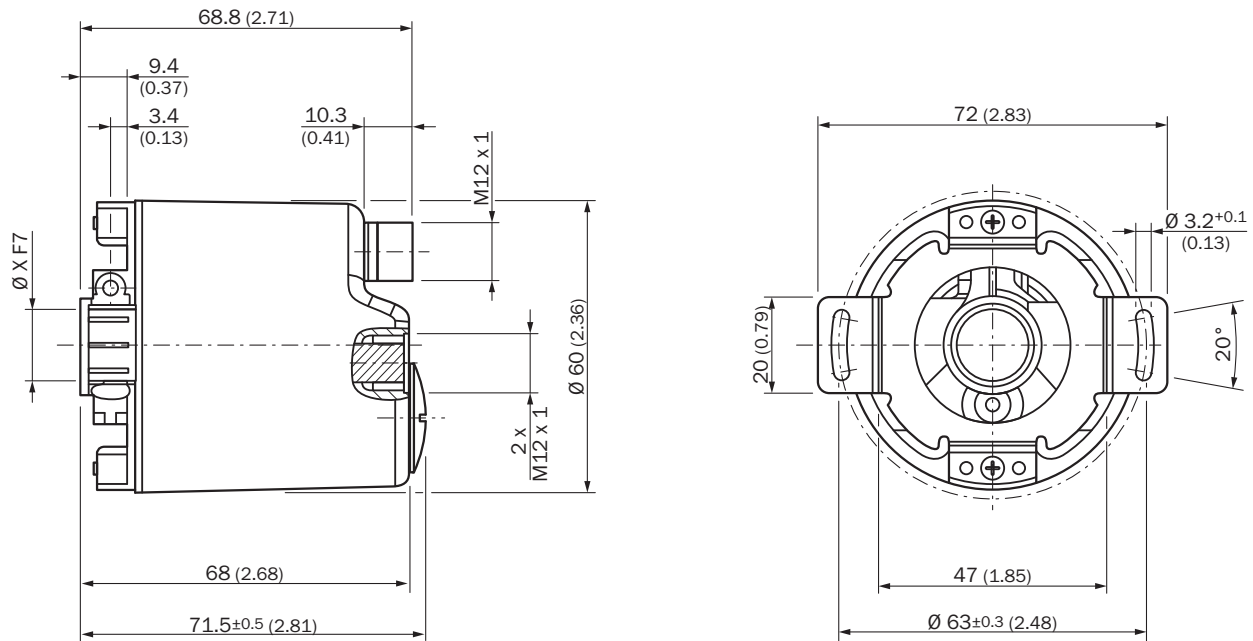

Diameter x f7 corresponds to the shaft diameter

Attachment specifications

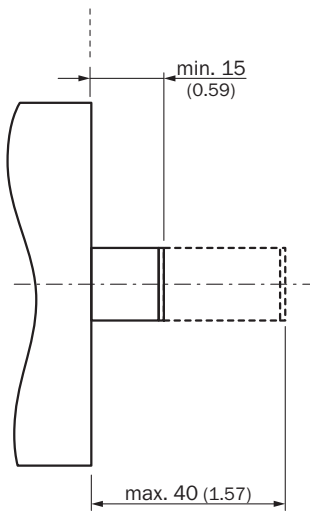

All dimensions in mm (inch)

PIN assignment

Male connector

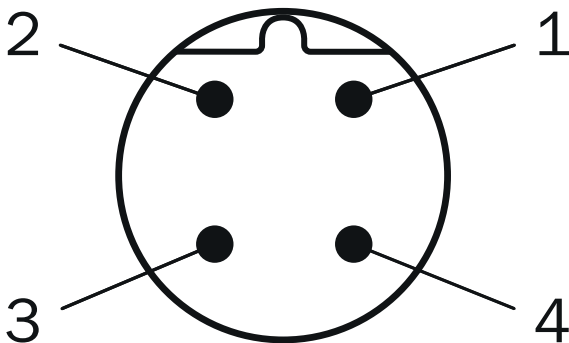

Supply voltage

| PIN | Signal |
|-----|---------------|
| 1 | 10 V ... 30 V |
| 2 | Not assigned |
| 3 | GND |
| 4 | Not assigned |

Female connector

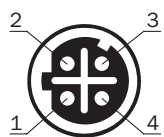

Port 1, Port 2

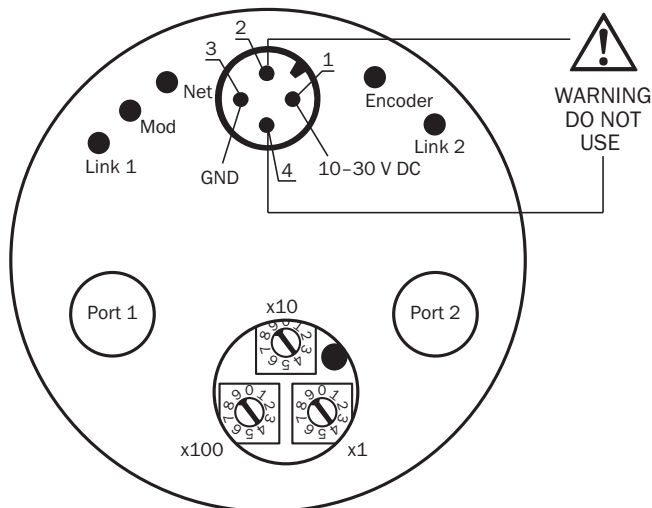

| PIN | Signal |
|-----|--------|
| 1 | T x D+ |
| 2 | R x D+ |
| 3 | T x D- |
| 4 | R x D- |

Connection diagram







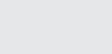

Recommended accessories

Other models and accessories → www.sick.com/AFS_AFM60_Ethernet

| | Brief description | Type | Part no. |
|---|---|------------------|----------|
| Flanges | | | |
|  | One-sided stator coupling, slot, slot radius 33 mm to 211.9 mm, slot width 5.1 mm | BEF-DS03DFS/VFS | 2047431 |
| Plug connectors and cables | | | |
|  | Head A: male connector, M12, 4-pin, straight, D-coded Head B: Flying leads Cable: Ethernet, PUR, halogen-free, shielded, 2 m | STL-1204-G02ME90 | 6045284 |
| | Head A: male connector, M12, 4-pin, straight, D-coded Head B: Flying leads Cable: Ethernet, PUR, halogen-free, shielded, 5 m | STL-1204-G05ME90 | 6045285 |
| | Head A: male connector, M12, 4-pin, straight, D-coded Head B: Flying leads Cable: Ethernet, PUR, halogen-free, shielded, 10 m | STL-1204-G10ME90 | 6045286 |
|  | Head A: male connector, M12, 4-pin, angled, D-coded Head B: Flying leads Cable: Ethernet, PUR, halogen-free, shielded, 2 m | STL-1204-W02ME90 | 6047912 |

| | Brief description | Type | Part no. |
|---|--|--------------------|----------|
|  | Head A: male connector, M12, 4-pin, angled, D-coded Head B: Flying leads Cable: Ethernet, PUR, halogen-free, shielded, 5 m | STL-1204-W05ME90 | 6047913 |
| | Head A: male connector, M12, 4-pin, angled, D-coded Head B: Flying leads Cable: Ethernet, PUR, halogen-free, shielded, 10 m | STL-1204-W10ME90 | 6047914 |
| | Head A: male connector, M12, 4-pin, angled, D-coded Head B: Flying leads Cable: Ethernet, PUR, halogen-free, shielded, 25 m | STL-1204-W25ME90 | 6047915 |
| | Head A: female connector, M12, 4-pin, straight, A-coded Head B: Flying leads Cable: Sensor/actuator cable, PUR, halogen-free, unshielded, 2 m | YF2A14-020UB3XLEAX | 2095607 |
| | Head A: female connector, M12, 4-pin, straight, A-coded Head B: Flying leads Cable: Sensor/actuator cable, PUR, halogen-free, unshielded, 5 m | YF2A14-050UB3XLEAX | 2095608 |
| | Head A: female connector, M12, 4-pin, straight, A-coded Head B: Flying leads Cable: Sensor/actuator cable, PUR, halogen-free, unshielded, 10 m | YF2A14-100UB3XLEAX | 2095609 |
| | Head A: female connector, M12, 4-pin, straight, A-coded Head B: Flying leads Cable: Sensor/actuator cable, PUR, halogen-free, unshielded, 25 m | YF2A14-250UB3XLEAX | 2095615 |
|  | Head A: female connector, M12, 4-pin, angled, A-coded Head B: Flying leads Cable: Sensor/actuator cable, PUR, halogen-free, unshielded, 2 m | YG2A14-020UB3XLEAX | 2095766 |
| | Head A: female connector, M12, 4-pin, angled, A-coded Head B: Flying leads Cable: Sensor/actuator cable, PUR, halogen-free, unshielded, 5 m | YG2A14-050UB3XLEAX | 2095767 |
| | Head A: female connector, M12, 4-pin, angled, A-coded Head B: Flying leads Cable: Sensor/actuator cable, PUR, halogen-free, unshielded, 10 m | YG2A14-100UB3XLEAX | 2095768 |
| | Head A: female connector, M12, 4-pin, angled, A-coded Head B: Flying leads Cable: Sensor/actuator cable, PUR, halogen-free, unshielded, 25 m | YG2A14-250UB3XLEAX | 2095771 |
|  | Head A: male connector, M12, 4-pin, straight, D-coded Head B: male connector, M12, 4-pin, straight, D-coded Cable: Ethernet, PUR, halogen-free, shielded, 2 m | SSL-1204-G02ME90 | 6045222 |
| | Head A: male connector, M12, 4-pin, straight, D-coded Head B: male connector, M12, 4-pin, straight, D-coded Cable: Ethernet, PUR, halogen-free, shielded, 5 m | SSL-1204-G05ME90 | 6045277 |
| | Head A: male connector, M12, 4-pin, straight, D-coded Head B: male connector, M12, 4-pin, straight, D-coded Cable: Ethernet, PUR, halogen-free, shielded, 10 m | SSL-1204-G10ME90 | 6045279 |
|  | Head A: male connector, M12, 4-pin, straight, D-coded Head B: male connector, RJ45, 8-pin, straight Cable: Ethernet, PUR, halogen-free, shielded, 2 m | SSL-2J04-G02ME60 | 6047916 |
| | Head A: male connector, M12, 4-pin, straight, D-coded Head B: male connector, RJ45, 8-pin, straight Cable: Ethernet, PUR, halogen-free, shielded, 5 m | SSL-2J04-G05ME60 | 6047917 |
| | Head A: male connector, M12, 4-pin, straight, D-coded Head B: male connector, RJ45, 8-pin, straight Cable: Ethernet, PUR, halogen-free, shielded, 10 m | SSL-2J04-G10ME60 | 6047918 |
|  | Head A: male connector, M12, 4-pin, angled, D-coded Head B: male connector, RJ45, 8-pin, straight Cable: Ethernet, PUR, halogen-free, shielded, 2 m | SSL-2J04-H02ME | 6047911 |

| | Brief description | Type | Part no. |
|--|--|---|----------|
| | Head A: male connector, M12, 4-pin, angled, D-coded Head B: male connector, RJ45, 8-pin, straight Cable: Ethernet, PUR, halogen-free, shielded, 5 m | SSL-2J04-H05ME | 6045287 |
| | Head A: male connector, M12, 4-pin, angled, D-coded Head B: male connector, RJ45, 8-pin, straight Cable: Ethernet, PUR, halogen-free, shielded, 10 m | SSL-2J04-H10ME | 6045288 |
|  | Head A: female connector, M12, 4-pin, straight, D-coded Cable: Ethernet, shielded | DOS-1204-GE | 6048153 |
|  | Head A: female connector, M12, 4-pin, angled Cable: unshielded | DOS-1204-W | 6007303 |
|  | Head A: female connector, M12, 4-pin, angled, D-coded Cable: Ethernet, shielded | DOS-1204-WE | 6048154 |
|  | Head A: male connector, RJ45, 8-pin, straight Cable: EtherNet/IP™, shielded | STE-0J08-GE | 6048150 |
|  | Head A: male connector, M12, 4-pin, straight, D-coded Cable: Ethernet, shielded | STE-1204-GE01 | 6048151 |
|  | Head A: male connector, M12, 4-pin, angled, D-coded Cable: Ethernet, shielded | STE-1204-WE | 6048152 |
|  | Head A: female connector, M12, 4-pin, D-coded Head B: female connector, RJ45, 8-pin Cable: Ethernet, shielded Cabinet through | Feedthrough female connector Ethernet RJ45 | 6048180 |

SICK AT A GLANCE

SICK is one of the leading manufacturers of intelligent sensors and sensor solutions for industrial applications. A unique range of products and services creates the perfect basis for controlling processes securely and efficiently, protecting individuals from accidents and preventing damage to the environment.

We have extensive experience in a wide range of industries and understand their processes and requirements. With intelligent sensors, we can deliver exactly what our customers need. In application centers in Europe, Asia and North America, system solutions are tested and optimized in accordance with customer specifications. All this makes us a reliable supplier and development partner.

Comprehensive services complete our offering: SICK LifeTime Services provide support throughout the machine life cycle and ensure safety and productivity.

For us, that is “Sensor Intelligence.”

WORLDWIDE PRESENCE:

Contacts and other locations –www.sick.com