

DOL-2312-G10MMA2

SICK
Sensor Intelligence.



Ordering information

Type	Part no.
DOL-2312-G10MMA2	2029209

Other models and accessories → www.sick.com/

Detailed technical data

Technical specifications

Accessory group	Plug connectors and cables
Accessory family	Connecting cables
Connection type head A	Female connector, M23, 12-pin, straight
Connection type head B	Flying leads
Locking nut material	Zinc die-cast, nickel-plated
Cable	10 m, 12-wire, PUR, halogen-free
Jacket material	PUR, halogen-free
Jacket color	Black
Cable diameter	7.8 mm
Conductor cross-section	4 x 2 x 0.25 mm ² + 2 x 0.5 mm ² + 2 x 0.14 mm ²
Shielding	Shielded
Bending radius	Stationary position > 5 x cable diameter Drag chain operation > 7.5 x cable diameter
Reference voltage	≤ 160 V
Current loading	7 A
Signal type	SSI
Enclosure rating	IP66/ IP67

Classifications

ECl@ss 5.0	19030312
ECl@ss 5.1.4	19030312
ECl@ss 6.0	27060304
ECl@ss 6.2	27060304
ECl@ss 7.0	27060304
ECl@ss 8.0	27060304
ECl@ss 8.1	27060304
ECl@ss 9.0	27060304
ECl@ss 10.0	27060304
ECl@ss 11.0	27060304
ECl@ss 12.0	27060304

ETIM 5.0	EC000830
ETIM 6.0	EC000830
ETIM 7.0	EC003249
ETIM 8.0	EC003249
UNSPSC 16.0901	26121604

Dimensional drawing (Dimensions in mm (inch))

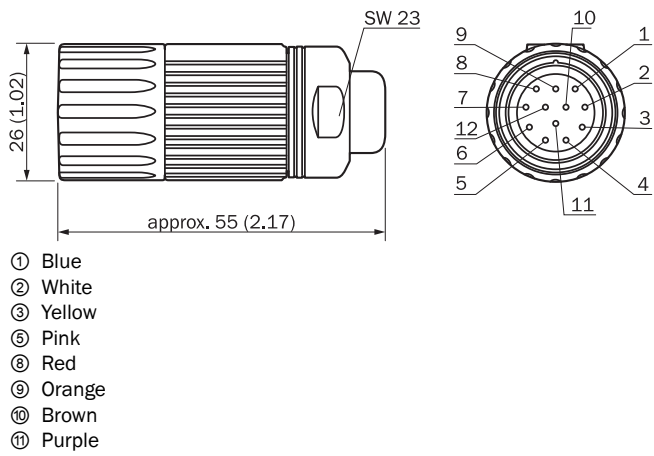

SICK AT A GLANCE

SICK is one of the leading manufacturers of intelligent sensors and sensor solutions for industrial applications. A unique range of products and services creates the perfect basis for controlling processes securely and efficiently, protecting individuals from accidents and preventing damage to the environment.

We have extensive experience in a wide range of industries and understand their processes and requirements. With intelligent sensors, we can deliver exactly what our customers need. In application centers in Europe, Asia and North America, system solutions are tested and optimized in accordance with customer specifications. All this makes us a reliable supplier and development partner.

Comprehensive services complete our offering: SICK LifeTime Services provide support throughout the machine life cycle and ensure safety and productivity.

For us, that is “Sensor Intelligence.”

WORLDWIDE PRESENCE:

Contacts and other locations –www.sick.com