



# GL6-CB011K00

FlexChain

SWITCHING AUTOMATION LIGHT GRIDS

**SICK**  
Sensor Intelligence.



Illustration may differ



### Ordering information

Type	Part no.
GL6-CB011K00	1091603

Only in conjunction with FlexChain host

[1091608](https://www.sick.com/1091608) | FC1A-AZ2A1A: Standard I/O

[1091609](https://www.sick.com/1091609) | FC1A-BZ2A1A: Advanced I/O

[1091610](https://www.sick.com/1091610) | FC1A-CZ2A1A: RS-485

[1091611](https://www.sick.com/1091611) | FC1A-DZ2A1A: CANopen

Other models and accessories → [www.sick.com/FlexChain](http://www.sick.com/FlexChain)

### Detailed technical data

#### Features

<b>Device version</b>	FlexChain Guest
<b>Sensor principle</b>	Photoelectric retro-reflective sensor Light grid system

#### Mechanics/electronics

<b>Light source</b>	PinPoint LED, visible red light
<b>Light spot size (distance)</b>	Ø 8 mm (350 mm)
<b>Wave length</b>	650 nm
<b>Supply voltage V<sub>s</sub></b>	12 V, via FlexChain (host)
<b>Adjustment</b>	Cable (Sensitivity) Via FlexChain (host)
<b>Dimensions (W x H x D)</b>	12 mm x 31.5 mm x 21 mm
<b>Connection type</b>	Male connector M8, 4-pin, Cable with female connector, M8, 4-pin, 1.5 m
<b>Housing material</b>	Plastic (ABS)
<b>Enclosure rating</b>	IP65, IP67
<b>Protection class</b>	III
<b>Weight</b>	Approx. 23 g

#### Performance

<b>Operating range</b>	6 m
------------------------	-----

#### Ambient data

<b>Shock resistance</b>	Single shocks 30 g, 11 ms 6 per axle Continuous shocks 25 g, 6 ms, 1,000 per axis
<b>Vibration resistance</b>	Sinusoidal oscillation 20-2,000 Hz 10 g, 3 h per axle

<sup>1)</sup> Sunlight.

<b>EMC</b>	EN 61000-6-2, EN 61000-6-3
<b>Ambient light immunity</b>	Direct: 22,000 lx <sup>1)</sup>
<b>Ambient operating temperature</b>	-25 °C ... +55 °C
<b>Ambient temperature, storage</b>	-25 °C ... +70 °C

<sup>1)</sup> Sunlight.

### Classifications

<b>eCl@ss 5.0</b>	27270910
<b>eCl@ss 5.1.4</b>	27270910
<b>eCl@ss 6.0</b>	27270910
<b>eCl@ss 6.2</b>	27270910
<b>eCl@ss 7.0</b>	27270910
<b>eCl@ss 8.0</b>	27270910
<b>eCl@ss 8.1</b>	27270910
<b>eCl@ss 9.0</b>	27270910
<b>eCl@ss 10.0</b>	27270910
<b>eCl@ss 11.0</b>	27270910
<b>eCl@ss 12.0</b>	27270910
<b>ETIM 5.0</b>	EC002549
<b>ETIM 6.0</b>	EC002549
<b>ETIM 7.0</b>	EC002549
<b>ETIM 8.0</b>	EC002549
<b>UNSPSC 16.0901</b>	39121528

### Dimensional drawing (Dimensions in mm (inch))

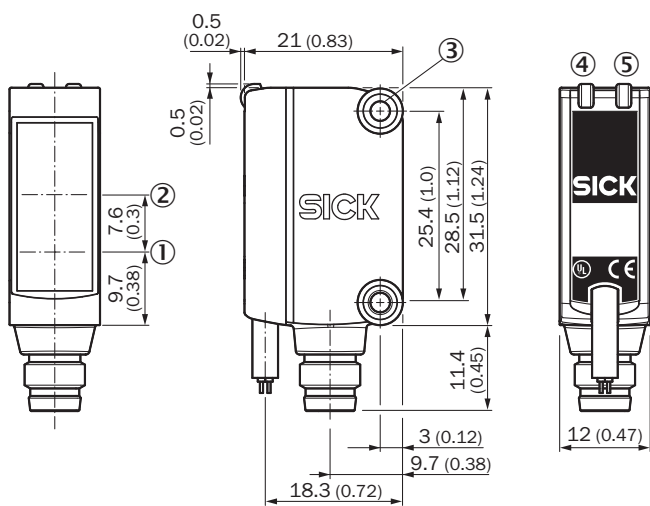

- ① Center of optical axis, sender
- ② Center of optical axis, receiver
- ③ Threaded mounting hole M3
- ④ LED indicator green
- ⑤ LED indicator yellow

Connection type and diagram

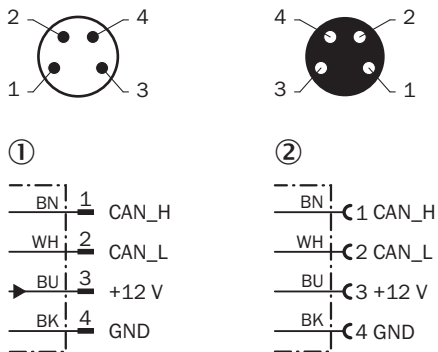

- ① Male connector M8, 4-pin
- ② Cable with female connector, M8, 4-pin

Operating reserve

GL6

Operating reserve

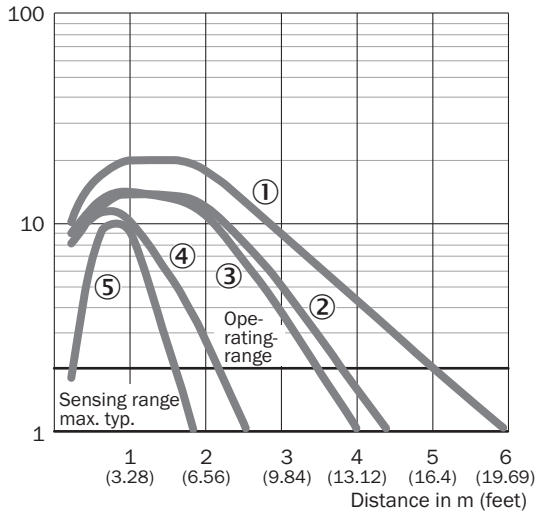

- ① Reflector PL80A
- ② Reflector PL40A
- ③ Reflector P250
- ④ Reflector PL20A
- ⑤ Reflective tape REF-IRF-56

Light spot size

GL6, GL6G

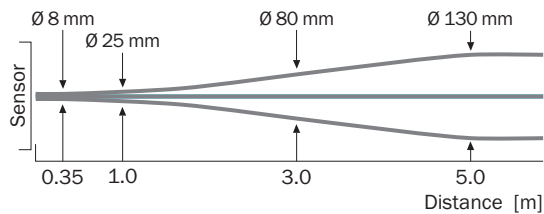

## Sensing range diagram

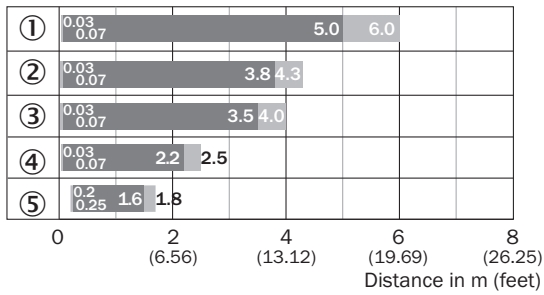

GL6, GL6G



- Sensing range
- Sensing range max.
- ① Reflector PL80A
- ② Reflector PL40A
- ③ Reflector P250
- ④ Reflector PL20A
- ⑤ Reflective tape REF-IRF-56

## Recommended accessories

Other models and accessories → [www.sick.com/FlexChain](http://www.sick.com/FlexChain)

	Brief description	Type	Part no.
<b>Mounting brackets and plates</b>			
	Stainless steel (1.4301)	BEF-WN-G6	2062909
<b>Reflectors</b>			
	Rectangular, screw connection, 51 mm x 61 mm, PMMA/ABS, Screw-on, 2 hole mounting	P250	5304812

## SICK AT A GLANCE

SICK is one of the leading manufacturers of intelligent sensors and sensor solutions for industrial applications. A unique range of products and services creates the perfect basis for controlling processes securely and efficiently, protecting individuals from accidents and preventing damage to the environment.

We have extensive experience in a wide range of industries and understand their processes and requirements. With intelligent sensors, we can deliver exactly what our customers need. In application centers in Europe, Asia and North America, system solutions are tested and optimized in accordance with customer specifications. All this makes us a reliable supplier and development partner.

Comprehensive services complete our offering: SICK LifeTime Services provide support throughout the machine life cycle and ensure safety and productivity.

For us, that is “Sensor Intelligence.”

## WORLDWIDE PRESENCE:

Contacts and other locations –[www.sick.com](http://www.sick.com)