



UC40-11311H

UC40

ULTRASONIC SENSORS

SICK
Sensor Intelligence.



Ordering information

Type	Part no.
UC40-11311H	6081949

Other models and accessories → www.sick.com/UC40



Detailed technical data

Mechanics/electronics

Supply voltage V_s	DC 9 V ... 30 V ^{1) 2)}
Power consumption	≤ 1.5 W ³⁾
Initialization time	< 300 ms
Design	Rectangular
Housing material	Plastic (PA 66) Ultrasonic transducer: polyurethane foam, glass epoxy resin
Connection type	Male connector, M12, 5-pin
Indication	4 x LED
Weight	120 g
Sending axis	Straight ⁴⁾
Dimensions (W x H x D)	40 mm x 40 mm x 66 mm
Enclosure rating	IP65 IP67
Protection class	III

¹⁾ Limit values, reverse-polarity protected Operation in short-circuit protected network: max. 8 A, class 2.

²⁾ 15 V ... 30 V when using the analog voltage output.

³⁾ Without load.

⁴⁾ Sensor head can be rotated 90°, additional 360° incremental alignment via mounting bracket.

Performance

Operating range, limiting range	200 mm ... 1,300 mm, 2,000 mm
Target	Natural objects
Resolution	≥ 1 mm
Repeatability	± 0.15 % ¹⁾
Accuracy	± 1 % ^{2) 3)}
Temperature compensation	✓

¹⁾ In relation to the current measured value, minimum value \geq resolution.

²⁾ Referring to current measurement value.

³⁾ Temperature compensation can be switched off, without temperature compensation: 0.17 % / K.

⁴⁾ Subsequent smoothing of the analog output, depending on the application, may increase the response time by up to 200 %.

Response time	96 ms ⁴⁾
Switching frequency	7 Hz
Output time	24 ms
Ultrasonic frequency (typical)	200 kHz
Detection area (typical)	See diagrams
Additional function	Adjustable operating modes: Switching point (Dt0) / Switching window/Background (ObSB) Teach-in of digital output Set levels of digital outputs Invertable digital output Set on delay digital output Teach-in of analog output Scaling of analog outputs Invertable analog output Automatic selection of analog current or voltage output Analog output switchable to second digital output Synchronization of up to 50 sensors Multiplexing: no cross talk of up to 50 sensors Adjustable measurement filters: Measured value filters/Filter strength/Foreground suppression/Detection area/Sensitivity and sound beam/False echo suppression Teach-in button(s) (can be deactivated) Reset to factory default

¹⁾ In relation to the current measured value, minimum value \geq resolution.

²⁾ Referring to current measurement value.

³⁾ Temperature compensation can be switched off, without temperature compensation: 0.17 % / K.

⁴⁾ Subsequent smoothing of the analog output, depending on the application, may increase the response time by up to 200 %.

Interfaces

IO-Link	✓, IO-Link V1.1
Function	Process data, parameterization, diagnosis, data storage
Digital output	
Number	1 ... 2 ¹⁾
Type	Push-pull: PNP/NPN
Function	Configurable Q2 output: analog output / digital output
Maximum output current I_A	≤ 100 mA
Analog output	
Number	1
Type	Current output / voltage output
Function	Automatic selection of analog current or voltage output dependent on load Configurable Q2 output: analog output / digital output
Current	4 mA ... 20 mA, $\leq 500 \Omega$ ²⁾
Voltage	0 V ... 10 V, $\geq 100,000 \Omega$
Resolution	12 bit
Multifunctional input (MF)	1 x MF
Hysteresis	20 mm

¹⁾ Push-pull: PNP/NPN HIGH = $U_V - (< 3$ V) / LOW < 3 V.

²⁾ For 4 mA ... 20 mA and $V_S \leq 20$ V max. load $\leq 100 \Omega$.

Ambient data

Ambient temperature, operation	-25 °C ... +70 °C
Ambient temperature, storage	-40 °C ... +85 °C

Classifications

eCl@ss 5.0	27270804
eCl@ss 5.1.4	27270804
eCl@ss 6.0	27270804
eCl@ss 6.2	27270804
eCl@ss 7.0	27270804
eCl@ss 8.0	27270804
eCl@ss 8.1	27270804
eCl@ss 9.0	27270804
eCl@ss 10.0	27270804
eCl@ss 11.0	27270804
eCl@ss 12.0	27272806
ETIM 5.0	EC001846
ETIM 6.0	EC001846
ETIM 7.0	EC001846
ETIM 8.0	EC001846
UNSPSC 16.0901	41111960

Dimensional drawing (Dimensions in mm (inch))

UC40-11311x

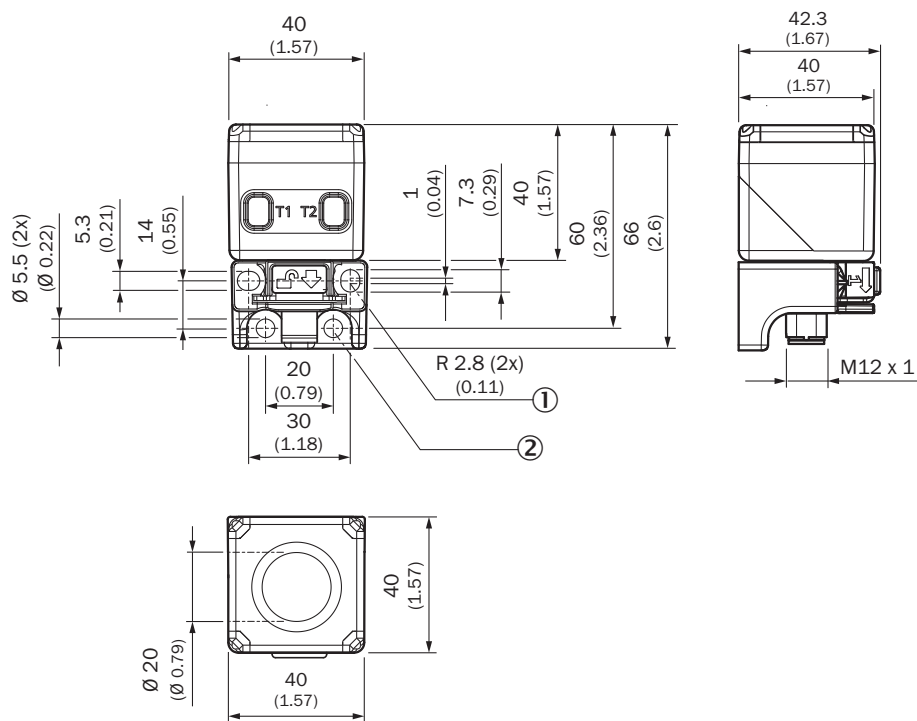

- ① 2 mounting holes, radius: 2.8 mm
- ② 2 mounting holes, diameter: 5.5 mm

Connection type

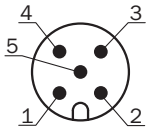

- ① L⁺: Supply voltage, brown
- ② N/C: Not assigned, white
- ③ M: Supply voltage 0 V, blue
- ④ Q/Q₁/C: Digital output, IO-Link communication, black
- ⑤ MF: Multifunction input, synchronization and multiplex operation, communication via Connect+ software, gray

Connection diagram

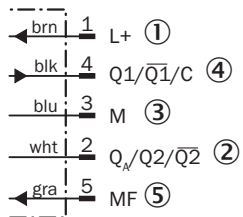

- ① Supply voltage
- ② Analog output or digital output 2
- ③ Supply voltage: 0 V
- ④ Digital output 1, IO-Link communication
- ⑤ Multifunction input (MF), synchronization and multiplex operation, communication via Connect+ software

Detection area



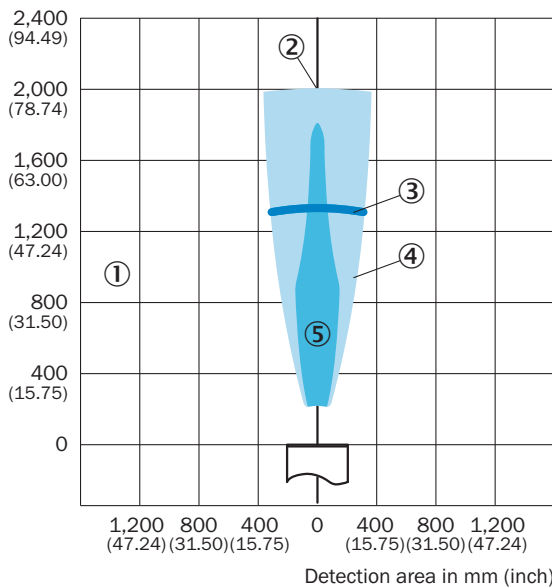

Detection area in mm (inch)



- ① Detection range dependent on reflection properties, size, and alignment of the object
- ② Limiting range
- ③ Operating range
- ④ Example object: aligned plate 500 mm x 500 mm
- ⑤ Example object: pipe with 27 mm diameter

Recommended accessories

Other models and accessories → www.sick.com/UC40

	Brief description	Type	Part no.
Connection modules			
	IO-Link V1.1 Class A port, USB2.0 port, optional external power supply 24V / 1A	IOLA2US-01101 (SiLink2 Master)	1061790
Plug connectors and cables			
	Head A: female connector, M12, 5-pin, straight, A-coded Head B: Flying leads Cable: Sensor/actuator cable, PVC, unshielded, 2 m	YF2A15- 020VB5XLEAX	2096239
Sensor Integration Gateway			
	<ul style="list-style-type: none"> • Further functions: USB connection for easy configuration of the SIG100 Sensor Integration Gateway with SOPAS ET, the engineering tool from SICK, logic editor is available for easy configuration of logic functions • I/O connection: 6 x M12, 5-pin female connector, A-coded • Connection CONFIG: 1 x M8, 4-pin female connector, USB 2.0 (USB-A) • Logic editor: yes • Communication interface: USB, IO-Link • Product category: IO-Link Hub 	SIG100-0A0111100	1089792
	<ul style="list-style-type: none"> • Logic editor: yes • Communication interface: PROFINET, REST API • Product category: IO-Link Master 	SIG200- 0A041220S01	1100615

SICK AT A GLANCE

SICK is one of the leading manufacturers of intelligent sensors and sensor solutions for industrial applications. A unique range of products and services creates the perfect basis for controlling processes securely and efficiently, protecting individuals from accidents and preventing damage to the environment.

We have extensive experience in a wide range of industries and understand their processes and requirements. With intelligent sensors, we can deliver exactly what our customers need. In application centers in Europe, Asia and North America, system solutions are tested and optimized in accordance with customer specifications. All this makes us a reliable supplier and development partner.

Comprehensive services complete our offering: SICK LifeTime Services provide support throughout the machine life cycle and ensure safety and productivity.

For us, that is “Sensor Intelligence.”

WORLDWIDE PRESENCE:

Contacts and other locations –www.sick.com