



# MZT8-2V8-N-KWDS03

MZT8 ATEX

SENSORS FOR T-SLOT CYLINDERS

**SICK**  
Sensor Intelligence.



### Ordering information

Type	Part no.
MZT8-2V8-N-KWDS03	1070464

Other models and accessories → [www.sick.com/MZT8\\_ATEX](http://www.sick.com/MZT8_ATEX)



### Detailed technical data

#### Features

<b>Cylinder type</b>	T-slot
<b>Cylinder types with adapter</b>	Profile cylinder Tie rod cylinder Round body cylinder Dovetail groove cylinder SMC rail CDQ2 SMC rail ECDQ2
<b>Housing length</b>	24 mm
<b>Switching output</b>	NAMUR
<b>Output characteristic</b>	Control current depending on switching state according to NAMUR EN 60947-5-6
<b>Switching frequency</b>	1,000 Hz
<b>Electrical wiring</b>	DC 2-wire
<b>Enclosure rating</b>	IP67 <sup>1)</sup>

<sup>1)</sup> According to EN 60529 (IP 67 / IP 68).

#### Mechanics/electronics

<b>Ex area category</b>	1G, 1D
<b>Device labeling</b>	II 1G Ex ia IIC T4 Ga, II 1D Ex ia IIIC T <sub>200</sub> 135 °C Da
<b>Response sensitivity, typ.</b>	2.8 mT
<b>Overrun distance, typ.</b>	9 mm
<b>Hysteresis, typ.</b>	≤ 0.5 mT
<b>Reproducibility</b>	≤ 0.1 mT <sup>1)</sup>
<b>Reverse polarity protection</b>	Yes
<b>Short-circuit protection</b>	Yes

<sup>1)</sup> Ub and Ta constant.

<sup>2)</sup> PVC-cable without UL-Certificate.

<sup>3)</sup> For connection to a separately certified intrinsically safe circuit only.

<b>Power-up pulse protection</b>	Yes
<b>Ambient operating temperature</b>	-25 °C ... +80 °C
<b>Shock and vibration resistance</b>	30 g, 11 ms / 10 ... 55 Hz, 1 mm
<b>EMC</b>	According to EN 60947-5-2
<b>Connection type</b>	Cable, 2-wire, 10 m
<b>Connection type Detail</b>	
Conductor cross section	0.12 mm <sup>2</sup>
Cable diameter	Ø 2.9 mm
Bending radius	With fixed installation > 3 x cable diameter For flexible use > 5 x cable diameter
Cable outlet	Axial
<b>Material</b>	
Housing	Plastic, PA12
Cable	PVC <sup>2)</sup>
<b>EC-Type examination certificate</b>	TÜV 14 ATEX 143125
<b>UK type examination certificate</b>	UL22UKEX2384
<b>Certificate (IECEX)</b>	IECEX TUN 14.0038
<b>Input voltage U<sub>i</sub> max.</b>	20 V <sup>3)</sup>
<b>Input power P<sub>i</sub> max.</b>	100 mW <sup>3)</sup>
<b>Input current I<sub>i</sub> max.</b>	60 mA <sup>3)</sup>
<b>Internal capacitance C<sub>i</sub> max.</b>	130 nF <sup>3)</sup>
<b>Internal inductance L<sub>i</sub> max.</b>	30 µH <sup>3)</sup>
<b>Nominal voltage</b>	8.2 V DC

<sup>1)</sup> U<sub>b</sub> and T<sub>a</sub> constant.

<sup>2)</sup> PVC-cable without UL-Certificate.

<sup>3)</sup> For connection to a separately certified intrinsically safe circuit only.

## Classifications

<b>eCl@ss 5.0</b>	27270104
<b>eCl@ss 5.1.4</b>	27270104
<b>eCl@ss 6.0</b>	27270104
<b>eCl@ss 6.2</b>	27270104
<b>eCl@ss 7.0</b>	27270104
<b>eCl@ss 8.0</b>	27270104
<b>eCl@ss 8.1</b>	27270104
<b>eCl@ss 9.0</b>	27270104
<b>eCl@ss 10.0</b>	27270104
<b>eCl@ss 11.0</b>	27270104
<b>eCl@ss 12.0</b>	27274301
<b>ETIM 5.0</b>	EC002544
<b>ETIM 6.0</b>	EC002544
<b>ETIM 7.0</b>	EC002544

<b>ETIM 8.0</b>	EC002544
<b>UNSPSC 16.0901</b>	39122230

### Installation note

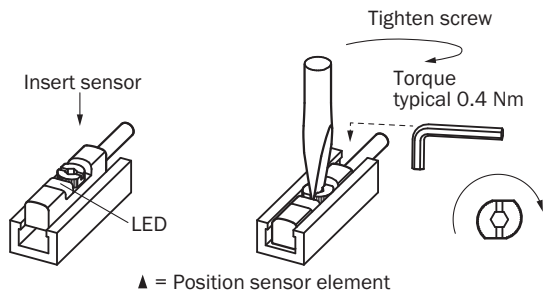

### Connection diagram

Cd-305

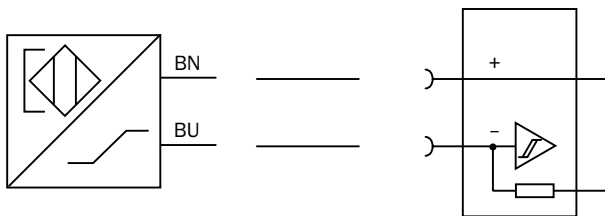

**Dimensional drawing** (Dimensions in mm (inch))

Cable

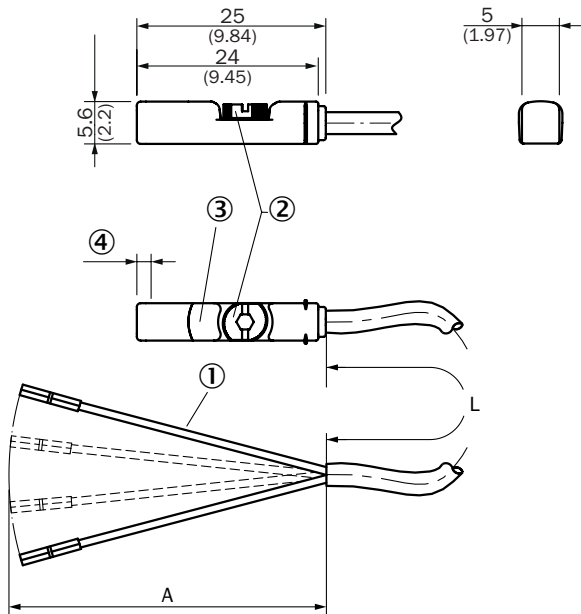









- ① Connection
- ② Fixing screw SW 2.0
- ③ Display LED
- ④ Sensor element position = long overrun distance (9 mm): 1.6 mm

Part no.	Type	L	A	Number of cores
1069424	MZT8-2V8-N-KW0	2 m	42 mm	2
1070456	MZT8-2V8-N-KWA	3 m	42 mm	2
1070461	MZT8-2V8-N-KWB	5 m	42 mm	2
1070462	MZT8-2V8-N-KWDS01	6 m	42 mm	2
1070463	MZT8-2V8-N-KWDS02	7 m	42 mm	2
1070464	MZT8-2V8-N-KWDS03	7 m	42 mm	2

**Recommended accessories**

Other models and accessories → [www.sick.com/MZT8\\_ATEX](http://www.sick.com/MZT8_ATEX)

	Brief description	Type	Part no.
<b>Power supply modules</b>			
	NAMUR isolating amplifier, Cable fault detection, Switching outputs: 2 NO relay (1 per channel), Supply voltage: 24 V ... 230 V, Voltage type: AC/DC	EN2-2EX1	6041096
	NAMUR isolating amplifier, Cable fault detection, Switching outputs: 2 NO relay (1 per channel), Supply voltage: 19,2 V ... 30 V, Voltage type: DC	EN2-2EX3	6041095

	Brief description	Type	Part no.
<b>Brackets for cylinder sensors</b>			
	Mounting bracket for cylinder with dovetail slot, Aluminum, without mounting hardware	BEF-KHZ-ST1	2022703
	Mounting bracket for integrated profile cylinder/tie-rod cylinder, zinc diecast, mounting hardware included	BEF-KHZ-PT1	2022702
	1 piece, Mounting bracket on round body cylinder with piston diameter of 12 mm, ambient temperature min 0 °C max 50 °C, plastic, Aluminum	BEF-KHZ-RT-12	2077681
	1 piece, Mounting bracket on round body cylinder with piston diameter of 16 mm, ambient temperature min 0 °C max 50 °C, plastic, Aluminum	BEF-KHZ-RT-16	2077680
	1 piece, Mounting bracket on round body cylinder with piston diameter of 20 mm, ambient temperature min 0 °C max 50 °C, plastic, Aluminum	BEF-KHZ-RT-20	2077679
	1 piece, Mounting bracket on round body cylinder with piston diameter of 25 mm, ambient temperature min 0 °C max 50 °C, plastic, Aluminum	BEF-KHZ-RT-25	2077678
	1 piece, Mounting bracket on round body cylinder with piston diameter of 32 mm, ambient temperature min 0 °C max 50 °C, plastic, Aluminum	BEF-KHZ-RT-32	2077677
	1 piece, Mounting bracket on round body cylinder with piston diameter of 40 mm, ambient temperature min 0 °C max 50 °C, plastic, Aluminum	BEF-KHZ-RT-40	2077676
	1 piece, Mounting bracket on round body cylinder with piston diameter of 50 mm, ambient temperature min 0 °C max 50 °C, plastic, Aluminum	BEF-KHZ-RT-50	2077675
	1 piece, Mounting bracket on round body cylinder with piston diameter of 63 mm, ambient temperature min 0 °C max 50 °C, plastic, Aluminum	BEF-KHZ-RT-63	2077674
	1 piece, Mounting bracket on round body cylinder with piston diameter of 8 mm ... 130 mm, ambient temperature min -30 °C max 80 °C, stainless steel, Zinc cast	BEF-KHZ-RT1-130	2077684
	1 piece, Mounting bracket on round body cylinder with piston diameter of 8 mm ... 25 mm, ambient temperature min -30 °C max 80 °C, stainless steel, Zinc cast	BEF-KHZ-RT1-25	2077682
	1 piece, Mounting bracket on round body cylinder with piston diameter of 8 mm ... 63 mm, ambient temperature min -30 °C max 80 °C, stainless steel, Zinc cast	BEF-KHZ-RT1-63	2077683
 	Mounting bracket for mounting on SMC rails CDQ2 (T-slot), Aluminum, without mounting hardware	BEF-KHZ-TT2	2046440
	Mounting bracket for mounting on SMC rails ECDQ2 (T-slot), Aluminum, without mounting hardware	BEF-KHZ-TT1	2046439
<b>Device protection (mechanical)</b>			
	Protective adapter, die-cast zinc, mounting hardware included	BEF-SG-MRZT	2077201

## SICK AT A GLANCE

SICK is one of the leading manufacturers of intelligent sensors and sensor solutions for industrial applications. A unique range of products and services creates the perfect basis for controlling processes securely and efficiently, protecting individuals from accidents and preventing damage to the environment.

We have extensive experience in a wide range of industries and understand their processes and requirements. With intelligent sensors, we can deliver exactly what our customers need. In application centers in Europe, Asia and North America, system solutions are tested and optimized in accordance with customer specifications. All this makes us a reliable supplier and development partner.

Comprehensive services complete our offering: SICK LifeTime Services provide support throughout the machine life cycle and ensure safety and productivity.

For us, that is “Sensor Intelligence.”

## WORLDWIDE PRESENCE:

Contacts and other locations –[www.sick.com](http://www.sick.com)