



# OD2-P120W60I0

OD Value

DISPLACEMENT MEASUREMENT SENSORS

**SICK**  
Sensor Intelligence.



Illustration may differ



## Ordering information

Type	Part no.
OD2-P120W60IO	6036629

Other models and accessories → [www.sick.com/OD\\_Value](http://www.sick.com/OD_Value)

## Detailed technical data

### Mechanics/electronics

<b>Supply voltage <math>V_s</math></b>	DC 12 V ... 24 V
<b>Power consumption</b>	$\leq 2.88 \text{ W}^{1)}$
<b>Warm-up time</b>	$\leq 30 \text{ min}$
<b>Housing material</b>	Plastic (PBT)
<b>Window material</b>	Plastic (PMMA)
<b>Connection type</b>	Male connector, M12, 8-pin, swivel connector unit
<b>Indication</b>	Distance bar graph, up to 8 status LEDs
<b>Weight</b>	70 g
<b>Dimensions (W x H x D)</b>	20.4 mm x 60 mm x 50 mm
<b>Enclosure rating</b>	IP67
<b>Protection class</b>	III

<sup>1)</sup> Without load, with current output.

### Performance

<b>Measuring range</b>	60 mm ... 180 mm <sup>1)</sup>
<b>Target</b>	Natural objects
<b>Repeatability</b>	$30 \mu\text{m}^{2) 3) 4)}$
<b>Linearity</b>	$\pm 120 \mu\text{m}^{2) 3) 5)}$
<b>Response time</b>	$\geq 1 \text{ ms}$

<sup>1)</sup> 6 % ... 90 % remission.

<sup>2)</sup> Measurement on 90 % remission (ceramic, white).

<sup>3)</sup> At averaging function medium.

<sup>4)</sup> Constant ambient conditions.

<sup>5)</sup> When calibrated in the application regularly.

<sup>6)</sup> Wavelength: 655 nm, max. output: 1 mW.

<b>Measuring frequency</b>	≤ 2 kHz <sup>1)</sup>
<b>Output time</b>	≥ 0.5 ms
<b>Light source</b>	Laser, red visible red light
<b>Laser class</b>	2 (IEC 60825-1:2014, EN 60825-1:2014) <sup>6)</sup>
<b>Typ. light spot size (distance)</b>	1 mm x 1.5 mm (120 mm)
<b>Additional function</b>	Mean-value setting 1 ... 64x, automatic sensitivity adjustment, Analog outputs can be taught in, Invertable analog output, Teach-in of digital output, Invertable switching output, multifunctional input: laser-off / external teach-in / trigger, switching mode: distance to object (DtO), switching mode: window (Wnd)

<sup>1)</sup> 6 % ... 90 % remission.

<sup>2)</sup> Measurement on 90 % remission (ceramic, white).

<sup>3)</sup> At averaging function medium.

<sup>4)</sup> Constant ambient conditions.

<sup>5)</sup> When calibrated in the application regularly.

<sup>6)</sup> Wavelength: 655 nm, max. output: 1 mW.

## Interfaces

<b>Digital output</b>	Number	2 <sup>1)</sup>
	Type	PNP
	Maximum output current I <sub>A</sub>	≤ 100 mA
<b>Analog output</b>	Number	1
	Type	Current output
	Current	4 mA ... 20 mA, ≤ 300 Ω
	Resolution	16 bit
<b>Multifunctional input (MF)</b>		1 x MF <sup>2)</sup>

<sup>1)</sup> PNP: HIGH = V<sub>S</sub> - (< 2 V) / LOW = < 2 V; NPN: HIGH = < 2 V / LOW = V<sub>S</sub>.

<sup>2)</sup> MF can be used as laser-off, trigger, external teach-in, or deactivated; response time ≤ 3 ms.

## Ambient data

<b>Ambient temperature, operation</b>	-10 °C ... +40 °C
<b>Ambient temperature, storage</b>	-20 °C ... +60 °C
<b>Relative air humidity (non-condensing)</b>	35 % ... 95 %
<b>Temperature drift</b>	± 0.08 % FS/K (FS = Full Scale = Measuring range of sensor)
<b>Typ. Ambient light immunity</b>	Artificial light: ≤ 3,000 lx Sunlight: ≤ 10,000 lx
<b>Vibration resistance</b>	10 Hz ... 55 Hz (amplitude 1.5 mm, x-, y-, z-axis 2 hours each)
<b>Shock resistance</b>	50 G (x, y, z axis 3 times each)

## Classifications

<b>eCl@ss 5.0</b>	27270801
<b>eCl@ss 5.1.4</b>	27270801
<b>eCl@ss 6.0</b>	27270801
<b>eCl@ss 6.2</b>	27270801
<b>eCl@ss 7.0</b>	27270801

# OD2-P120W60IO | OD Value

## DISPLACEMENT MEASUREMENT SENSORS

<b>eCl@ss 8.0</b>	27270801
<b>eCl@ss 8.1</b>	27270801
<b>eCl@ss 9.0</b>	27270801
<b>eCl@ss 10.0</b>	27270801
<b>eCl@ss 11.0</b>	27270801
<b>eCl@ss 12.0</b>	27270916
<b>ETIM 5.0</b>	EC001825
<b>ETIM 6.0</b>	EC001825
<b>ETIM 7.0</b>	EC001825
<b>ETIM 8.0</b>	EC001825
<b>UNSPSC 16.0901</b>	41111613

### Dimensional drawing (Dimensions in mm (inch))

OD2-x120W60xx

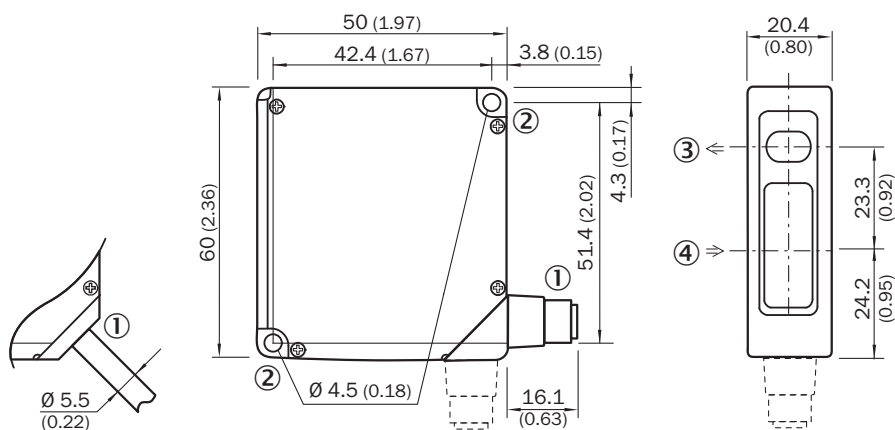

- ① 2 m cable or M12 connector; 90° rotatable
- ② Mounting hole, Ø 4.5 mm
- ③ Optical axis, sender
- ④ Optical axis, receiver

### Connection type

OD2-xxxxxA0 OD2-xxxxxC0 OD2-xxxxxI0 OD2-xxxxxU0 connector M12, 8-pin

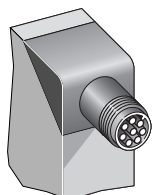

### Connection diagram

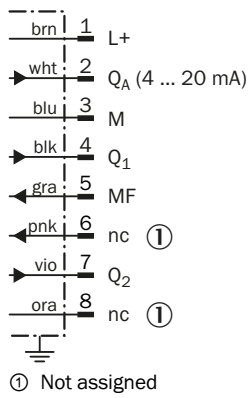

### Adjustment possible

OD2-xxxxxxIx

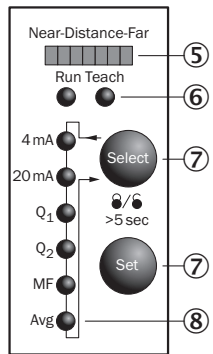

- ⑤ Distance indicator
- ⑥ Mode indicator (Run/Teach)
- ⑦ Control elements
- ⑧ Status indicator in- and outputs (Run-mode)/menu indicator (Teach-mode)

### Light spot size

OD2-x120W60xx

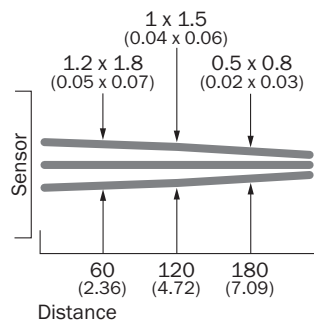

All dimensions in mm (inch)

## Linearity

OD2-x120xxxx

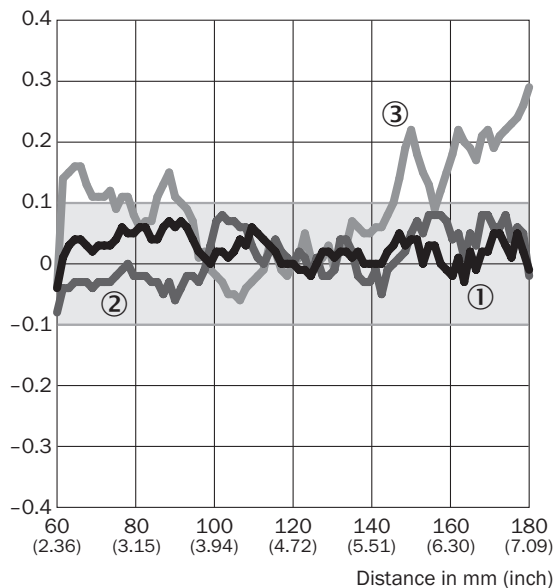

Linearity [%FS]



- ① White ceramic
- ② Black paper
- ③ Stainless steel

## Recommended accessories

Other models and accessories → [www.sick.com/OD\\_Value](http://www.sick.com/OD_Value)

	Brief description	Type	Part no.
<b>Mounting brackets and plates</b>			
	Stainless-steel mounting bracket, stainless steel	BEF-WN-OD1000	4089813
<b>Plug connectors and cables</b>			
	Head A: female connector, M12, 8-pin, straight Head B: Flying leads Cable: Sensor/actuator cable, special color code, PVC, shielded, 2 m	DOL-1208-G02MF	6020663

## Recommended services

Additional services → [www.sick.com/OD\\_Value](http://www.sick.com/OD_Value)

	Type	Part no.
Warranty extensions		
<ul style="list-style-type: none"> <li>• <b>Product area:</b> Identification solutions, machine vision, Distance sensors, Detection and ranging solutions</li> <li>• <b>Range of services:</b> The services correspond to the scope of the statutory manufacturer warranty (SICK general terms and conditions of purchase)</li> <li>• <b>Duration:</b> Five-year warranty from delivery date.</li> </ul>	Extended warranty for a total of five years from delivery date	1680671
Commissioning		
<ul style="list-style-type: none"> <li>• <b>Product area:</b> Displacement measurement sensors</li> <li>• <b>Range of services:</b> Inspection of connection and mounting, optimization of parameters of SICK product as well as tests, set-up of previously defined functions of the scaling of the analog measuring range, switching point position, hysteresis, measuring frequency, measured value filter, signal quality, evaluation function, or communication interface</li> <li>• <b>Travel expenses:</b> The prices do not include travel costs such as hotel, flight, travel time and expenses.</li> <li>• <b>Duration:</b> Additional work will be invoiced separately</li> </ul>	DT20 Hi/OD/OL commissioning	1612241

## SICK AT A GLANCE

SICK is one of the leading manufacturers of intelligent sensors and sensor solutions for industrial applications. A unique range of products and services creates the perfect basis for controlling processes securely and efficiently, protecting individuals from accidents and preventing damage to the environment.

We have extensive experience in a wide range of industries and understand their processes and requirements. With intelligent sensors, we can deliver exactly what our customers need. In application centers in Europe, Asia and North America, system solutions are tested and optimized in accordance with customer specifications. All this makes us a reliable supplier and development partner.

Comprehensive services complete our offering: SICK LifeTime Services provide support throughout the machine life cycle and ensure safety and productivity.

For us, that is “Sensor Intelligence.”

## WORLDWIDE PRESENCE:

Contacts and other locations –[www.sick.com](http://www.sick.com)