



MICS3-AAAZ55AZ1P01

microScan3

SAFETY LASER SCANNERS

SICK
Sensor Intelligence.



Illustration may differ

Ordering information

| Integration in the control system | Sub product family | Protective field range | Number of fields | Number of monitoring cases | Connection type | Type | Part no. |
|-----------------------------------|---------------------|------------------------|------------------|----------------------------|-----------------|--------------------|----------|
| Local inputs and outputs (I/O) | microScan3 Core I/O | 5.5 m | 8 | 2 | M12 | MICS3-AAAZ55AZ1P01 | 1075843 |

Other models and accessories → www.sick.com/microScan3



Detailed technical data

Features

| | |
|--|--|
| Model | Sensor including system plug |
| Application | Indoor |
| Protective field range | 5.5 m |
| Warning field range | 40 m |
| Number of simultaneously monitored fields | ≤ 4 ^{1) 2)} |
| Number of fields | 8 ³⁾ |
| Number of monitoring cases | 2 |
| Scanning angle | 275° |
| Resolution (can be configured) | 30 mm 40 mm 50 mm 70 mm 150 mm 200 mm |
| Angular resolution | 0.39° |
| Response time | ≥ 70 ms |
| Protective field supplement | 65 mm |

¹⁾ Protection, warning or contour detection fields.

²⁾ Please note the number of available OSSD pairs.

³⁾ Please note the number of available inputs and OSSD pairs.

Safety-related parameters

| | |
|-------------------------------|---------------------------|
| Type | Type 3 (IEC 61496) |
| Safety integrity level | SIL2 (IEC 61508) |
| Category | Category 3 (EN ISO 13849) |
| Performance level | PL d (EN ISO 13849) |

| | |
|---|--|
| PFH_D (mean probability of a dangerous failure per hour) | 8.0 x 10 ⁻⁸ |
| T_M (mission time) | 20 years (EN ISO 13849) |
| Safe state in the event of a fault | At least one OSSD is in the OFF state. |

Functions

| | |
|--|------|
| Restart interlock | ✓ |
| External device monitoring (EDM) | ✓ |
| Multiple sampling | ✓ |
| Monitoring case switching | ✓ |
| Simultaneous monitoring | ✓ |
| Static protective field switching | ✓ |
| Safe contour detection | ✓ |
| Contour as a reference | ✓ |
| Integrated configuration memory | ✓ |
| Measured data output | None |

Interfaces

| | |
|--|---|
| Connection type | Male connector, M12, 8 pin, A-coded (common male connector for power supply and inputs and outputs) |
| Universal I/Os | 3 |
| Outputs | 1 |
| OSSD pairs | |
| Configuration method | PC with Safety Designer (Configuration and Diagnostic Software) |
| Configuration and diagnostics interface | USB 2.0, Mini-USB |
| Display elements | Graphic color display, LEDs |

Electrical data

| | |
|-------------------------------------|---------------------------------|
| Protection class | III (EN 61140) |
| Supply voltage V_s | 24 V DC (16.8 V DC ... 30 V DC) |
| Power consumption typical | 7 W (without output load) |

Mechanical data

| | |
|------------------------------------|--|
| Dimensions (W x H x D) | 112 mm x 135.1 mm x 111.1 mm |
| Weight | 1.15 kg |
| Housing material | Aluminum |
| Housing color | RAL 1021 (yellow), RAL 9005 (black) |
| Optics cover material | Polycarbonate |
| Optics cover surface finish | Outside with scratch-resistant coating |

Ambient data

| | |
|--------------------------------------|--------------------------|
| Enclosure rating | IP65 (IEC 60529) |
| Ambient light immunity | ≤ 3,000 lx (IEC 61496-3) |
| Ambient operating temperature | -10 °C ... +50 °C |
| Storage temperature | -25 °C ... +70 °C |

| | | |
|-----------------------------|------------------|--|
| Vibration resistance | | IEC 60068-2-6, IEC 60068-2-64, IEC 60721-3-5, IEC TR 60721-4-3, IEC 61496-1, IEC 61496-3 |
| | Class | 5M1 (IEC 60721-3-5) 3M4 (IEC TR 60721-4-3) |
| Shock resistance | | IEC 60068-2-27, IEC 60721-3-5, IEC TR 60721-4-3, IEC 61496-1, IEC 61496-3 |
| | Class | 5M1 (IEC 60721-3-5) 3M4 (IEC TR 60721-4-3) |
| | Continuous shock | 100 m/s ² , 16 ms 150 m/s ² , 6 ms |
| EMC | | IEC 61496-1 IEC 61000-6-2 IEC 61000-6-4 |

Other information

| | |
|------------------------------------|--|
| Type of light | Pulsed laser diode |
| Wave length | 845 nm |
| Detectable remission factor | 1.8% to several 1000% |
| Laser class | 1M (21 CFR 1040.10 and 1040.11, IEC 60825-1) |

Classifications

| | |
|-----------------------|----------|
| eCl@ss 5.0 | 27272705 |
| eCl@ss 5.1.4 | 27272705 |
| eCl@ss 6.0 | 27272705 |
| eCl@ss 6.2 | 27272705 |
| eCl@ss 7.0 | 27272705 |
| eCl@ss 8.0 | 27272705 |
| eCl@ss 8.1 | 27272705 |
| eCl@ss 9.0 | 27272705 |
| eCl@ss 10.0 | 27272705 |
| eCl@ss 11.0 | 27272705 |
| eCl@ss 12.0 | 27272705 |
| ETIM 5.0 | EC002550 |
| ETIM 6.0 | EC002550 |
| ETIM 7.0 | EC002550 |
| ETIM 8.0 | EC002550 |
| UNSPSC 16.0901 | 39121528 |

Dimensional drawing (Dimensions in mm (inch))

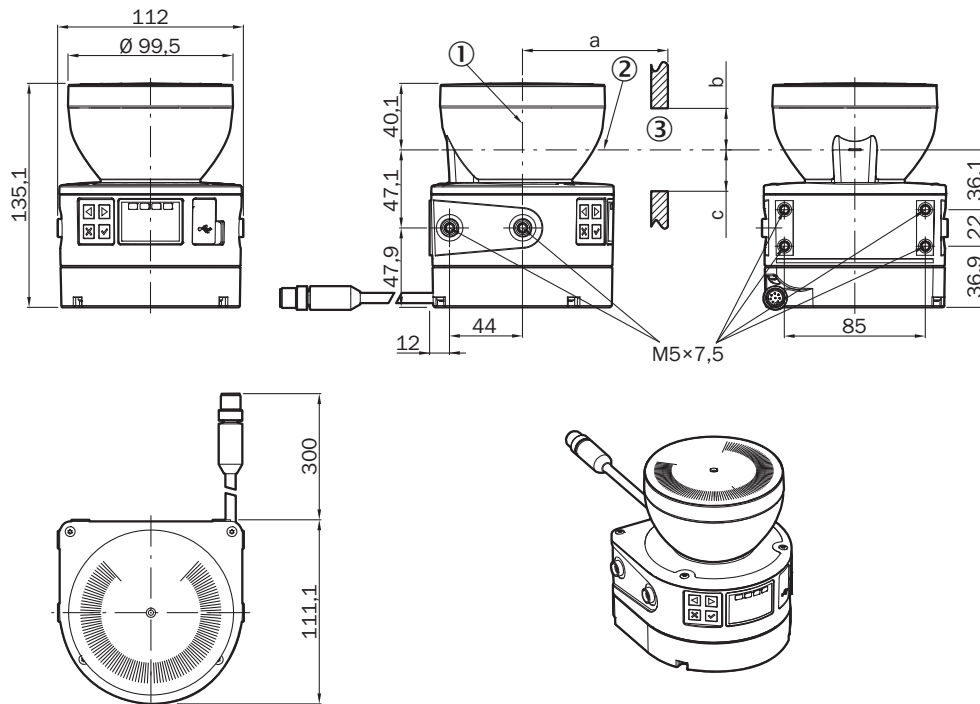

- ① Mirror axis of rotation
- ② Scan plane
- ③ Required viewing slit (a: length of the viewing slit, b: minimum height above the scan plane, c: minimum height below the scan plane. See the operating instructions for details.)

Pin assignment

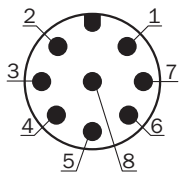

| Pin | Designation | Description |
|-----|-------------|-------------------------------|
| 1 | +24 V DC | Supply voltage +24 V DC |
| 2 | OSSD 1.A | OSSD pair 1, OSSD A |
| 3 | 0 V DC | Supply voltage 0 V DC |
| 4 | OSSD 1.B | OSSD pair 1, OSSD B |
| 5 | Uni-I/O 1 | Universal I/O 1, configurable |
| 6 | Uni-I/O 2 | Universal I/O 2, configurable |
| 7 | Uni-I/O 3 | Universal I/O 3, configurable |
| 8 | FE | Functional earth/shielding |

For details see operating instructions

Connection diagram

microScan3 Core I/O with restart interlock and external device monitoring at RLY3-OSSD1 safety relay

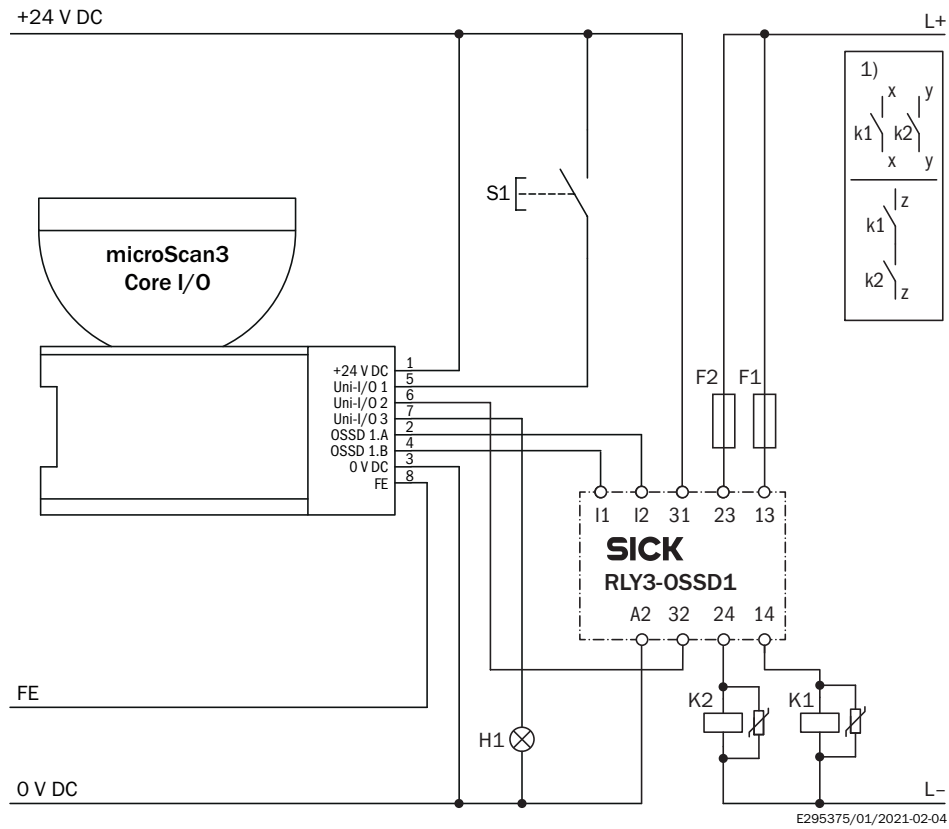

① Output circuits: These contacts must be incorporated into the control such that the dangerous state is brought to an end if the output circuit is open. For categories 4 and 3, they must be incorporated on dual-channels (x, y paths). Single-channel incorporation into the control (z path) is only possible with a single-channel control and taking the risk analysis into account.

Uni-I/O 1: configured as input reset

Uni-I/O 2: configured as input external device monitoring (EDM)

Uni-I/O 3: configured as output reset required

microScan3 Core I/O with restart interlock and external device monitoring

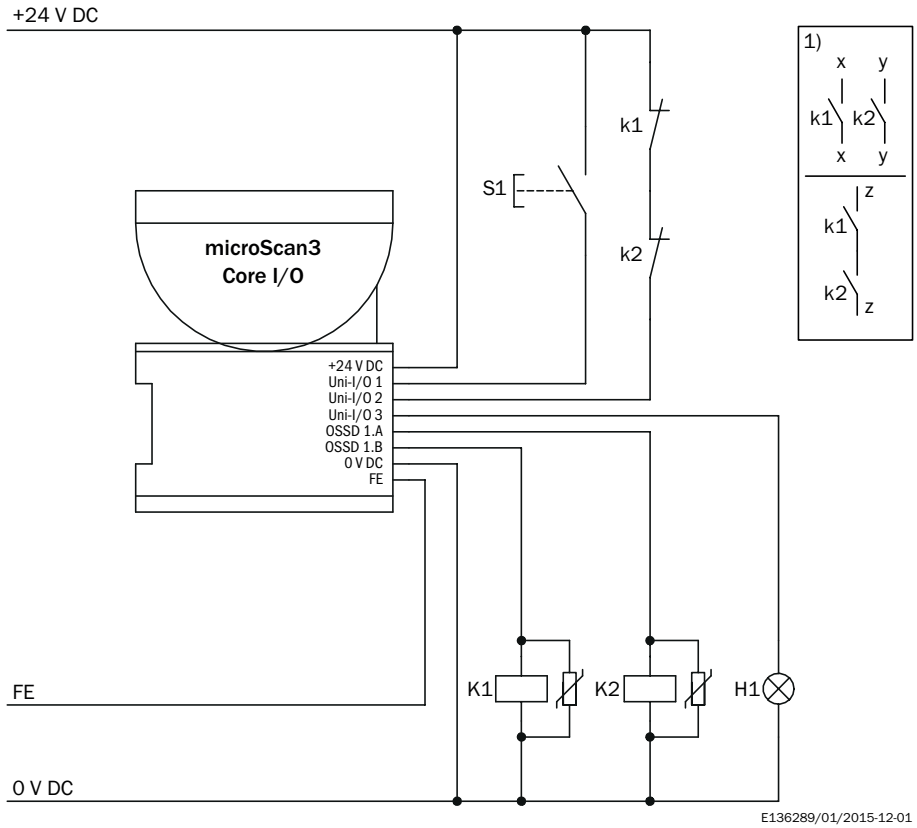



E136289/01/2015-12-01







① Output circuits: These contacts must be incorporated into the control such that the dangerous state is brought to an end if the output circuit is open. For categories 4 and 3, they must be incorporated on dual-channels (x, y paths). Single-channel incorporation into the control (z path) is only possible with a single-channel control and taking the risk analysis into account.

- Uni-I/O 1: configured as input reset
- Uni-I/O 2: configured as input external device monitoring (EDM)
- Uni-I/O 3: configured as output reset required

Recommended accessories

Other models and accessories → www.sick.com/microScan3

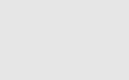
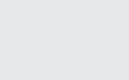
| | Brief description | Type | Part no. |
|---|---|--|----------|
| Mounting brackets and plates | | | |
|  | 1 piece, mounting bracket, heavy-duty version, with protection cover, for floor mounting, height adjustment possible from 90 ... 310 mm, scanner tilt angle: ± 5°. Additional mounting brackets are not required. ¹⁾ steel, painted (RAL 1021) | Heavy-duty mounting kit for floor mounting | 2102289 |
|  | 1 piece, mounting bracket 150 mm for floor mounting of microScan3, stainless steel, Bracket and 4 x M5 screws for attaching the microScan3 | Mounting bracket 150 mm for floor mounting of microScan3 | 2112950 |
|  | 1 piece, mounting bracket 300 mm for floor mounting of microScan3, stainless steel, Bracket and 4 x M5 screws for attaching the microScan3 | Mounting bracket 300 mm for floor mounting of microScan3 | 2112951 |

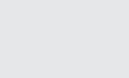
| | Brief description | Type | Part no. |
|---|--|---|----------|
|  | 1 piece, mounting bracket, Stainless steel V2A (1.4301), powder-coated IGP-DURA face 5803A | Mounting kit 1a | 2073851 |
|  | 1 piece, mounting bracket with protection of optics hood, Stainless steel V2A (1.4301), powder-coated IGP-DURA face 5803A | Mounting kit 1b | 2074242 |
|  | 1 piece, alignment bracket, alignment with cross-wise axis and depth axis possible, distance between mounting surface and device: 22.3 mm, only in conjunction with mounting kit 1a (2073851) or 1b (2074242), Stainless steel V2A (1.4301), powder-coated IGP-DURA face 5803A | Mounting kit 2a | 2073852 |
| Plug connectors and cables | | | |
|  | Head A: female connector, M12, 8-pin, straight, A-coded Head B: Flying leads Cable: Sensor/actuator cable, PUR, halogen-free, unshielded, 2 m | DOL-1208G02MD25KM1 | 2079314 |
|  | Head A: female connector, M12, 8-pin, straight, A-coded Head B: Flying leads Cable: Sensor/actuator cable, PUR, halogen-free, unshielded, 5 m | DOL-1208G05MD25KM1 | 2079315 |
|  | Head A: female connector, M12, 8-pin, straight, A-coded Head B: Flying leads Cable: Sensor/actuator cable, PUR, halogen-free, unshielded, 10 m | DOL-1208G10MD25KM1 | 2079316 |
|  | Head A: female connector, M12, 8-pin, straight, A-coded Head B: Flying leads Cable: Sensor/actuator cable, PUR, halogen-free, unshielded, 20 m | DOL-1208G20MD25KM1 | 2092105 |
|  | Head A: female connector, M12, 8-pin, straight, A-coded Head B: Flying leads Cable: Sensor/actuator cable, PUR, halogen-free, unshielded, 30 m | DOL-1208G30MD25KM1 | 2092106 |
|  | Head A: male connector, USB-A, straight Head B: male connector, Mini-USB, straight Cable: USB, shielded, 3 m For connecting the configuration connection to the USB interface on the PC | Connection cable (male connector- male connector) | 6042517 |
|  | Head A: male connector, USB-A, straight Head B: male connector, Mini-USB, straight Cable: USB, shielded, 5 m For connecting the configuration connection to the USB interface on the PC | | 6053566 |

SICK AT A GLANCE

SICK is one of the leading manufacturers of intelligent sensors and sensor solutions for industrial applications. A unique range of products and services creates the perfect basis for controlling processes securely and efficiently, protecting individuals from accidents and preventing damage to the environment.

We have extensive experience in a wide range of industries and understand their processes and requirements. With intelligent sensors, we can deliver exactly what our customers need. In application centers in Europe, Asia and North America, system solutions are tested and optimized in accordance with customer specifications. All this makes us a reliable supplier and development partner.

Comprehensive services complete our offering: SICK LifeTime Services provide support throughout the machine life cycle and ensure safety and productivity.

For us, that is “Sensor Intelligence.”

WORLDWIDE PRESENCE:

Contacts and other locations –www.sick.com