



# GL10-F4631S11

G10

SMALL PHOTOELECTRIC SENSORS

**SICK**  
Sensor Intelligence.



### Ordering information

| Type          | Part no. |
|---------------|----------|
| GL10-F4631S11 | 1102890  |

Other models and accessories → [www.sick.com/G10](http://www.sick.com/G10)

Illustration may differ



### Detailed technical data

#### Features

|  |  |
|--|--|
| <b>Device type</b>                     | Photoelectric sensors  |
| <b>Sensor/ detection principle</b>     | Photoelectric retro-reflective sensor, Dual lens                 |
| <b>Dimensions (W x H x D)</b>          | 20 mm x 50 mm x 39 mm  |
| <b>Housing design (light emission)</b> | Rectangular  |
| <b>Sensing range max.</b>              | 0.15 m ... 17 m <sup>1)</sup><br>0.15 m ... 12.5 m <sup>2)</sup> |
| <b>Sensing range</b>                   | 0.15 m ... 14 m <sup>1)</sup><br>0.15 m ... 10.5 m <sup>2)</sup> |
| <b>Type of light</b>                   | Visible red light  |
| <b>Light source</b>                    | PinPoint LED <sup>3)</sup>                                       |
| <b>Light spot size (distance)</b>      | Ø 58 mm (5 m)  |
| <b>Wave length</b>                     | 625 nm   |
| <b>Adjustment</b>                      | Potentiometer, 270°  |

<sup>1)</sup> Reflector PL80A.

<sup>2)</sup> Reflector P250.

<sup>3)</sup> Average service life: 100,000 h at T<sub>J</sub> = +25 °C.

## Mechanics/electronics

|  |  |
|--|--|
| <b>Supply voltage</b>                      | 10 V DC ... 30 V DC <sup>1)</sup>  |
| <b>Ripple</b>                              | < 5 V <sub>pp</sub> <sup>2)</sup>  |
| <b>Current consumption</b>                 | 20 mA  |
| <b>Switching output</b>                    | PNP  |
| <b>Output function</b>                     | Complementary  |
| <b>Switching mode</b>                      | Light switching  |
| <b>Output current I<sub>max.</sub></b>     | ≤ 100 mA   |
| <b>Response time</b>                       | ≤ 1,250 μs <sup>3)</sup>   |
| <b>Switching frequency</b>                 | 400 Hz <sup>4)</sup>   |
| <b>Connection type</b>                     | Male connector M12, 4-pin  |
| <b>Circuit protection</b>                  | A <sup>5)</sup><br>B <sup>6)</sup><br>C <sup>7)</sup><br>D <sup>8)</sup> |
| <b>Protection class</b>                    | III  |
| <b>Weight</b>                              | 35 g   |
| <b>Polarisation filter</b>                 | ✓  |
| <b>Housing material</b>                    | Plastic, ABS/PMMA  |
| <b>Enclosure rating</b>                    | IP67   |
| <b>Electromagnetic compatibility (EMC)</b> | EN 60947-5-2   |
| <b>Ambient operating temperature</b>       | -30 °C ... +60 °C  |
| <b>Ambient temperature, storage</b>        | -40 °C ... +70 °C  |
| <b>UL File No.</b>                         | NRKH.E348498 & NRKH7.E348498   |
| <b>More standards</b>                      | UL325 <sup>9)</sup>  |

<sup>1)</sup> Limit values when operated in short-circuit protected network: max. 8 A.

<sup>2)</sup> May not exceed or fall below U<sub>v</sub> tolerances.

<sup>3)</sup> Signal transit time with resistive load.

<sup>4)</sup> With light/dark ratio 1:1.

<sup>5)</sup> A = V<sub>S</sub> connections reverse-polarity protected.

<sup>6)</sup> B = inputs and output reverse-polarity protected.

<sup>7)</sup> C = interference suppression.

<sup>8)</sup> D = outputs overcurrent and short-circuit protected.

<sup>9)</sup> Complies with the UL325 standard when used with sturdy protection hood (e.g. BEF-G10WSG, 2071960).

## Classifications

|                     |          |
|---------------------|----------|
| <b>ECl@ss 5.0</b>   | 27270902 |
| <b>ECl@ss 5.1.4</b> | 27270902 |
| <b>ECl@ss 6.0</b>   | 27270902 |
| <b>ECl@ss 6.2</b>   | 27270902 |
| <b>ECl@ss 7.0</b>   | 27270902 |
| <b>ECl@ss 8.0</b>   | 27270902 |
| <b>ECl@ss 8.1</b>   | 27270902 |
| <b>ECl@ss 9.0</b>   | 27270902 |

|                       |          |
|-----------------------|----------|
| <b>ECI@ss 10.0</b>    | 27270902 |
| <b>ECI@ss 11.0</b>    | 27270902 |
| <b>ETIM 5.0</b>       | EC002717 |
| <b>ETIM 6.0</b>       | EC002717 |
| <b>ETIM 7.0</b>       | EC002717 |
| <b>ETIM 8.0</b>       | EC002717 |
| <b>UNSPSC 16.0901</b> | 39121528 |

### Connection diagram

Cd-083

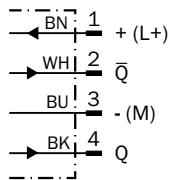

### Characteristic curve

Operating reserve

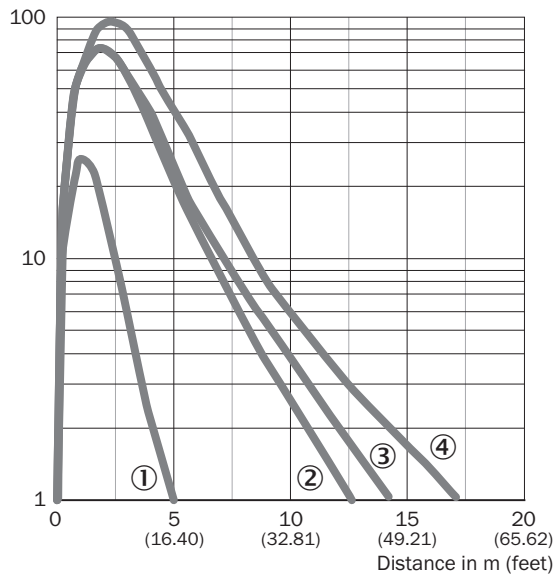

- ① Reflective tape REF-IRF-56
- ② Reflector P250
- ③ Reflector PL40A
- ④ Reflector PL80A

## Light spot size

Light spot size

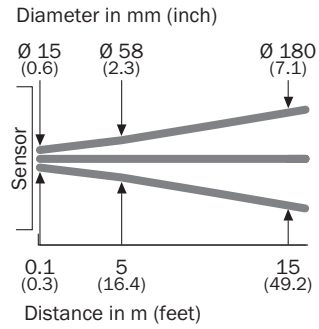

## Sensing range diagram

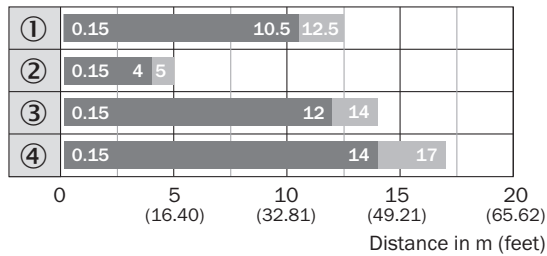

■ Sensing range      ■ Sensing range max.

- ① Reflector P250
- ② Reflective tape REF-IRF-56
- ③ Reflector PL40A
- ④ Reflector PL80A

## Adjustments

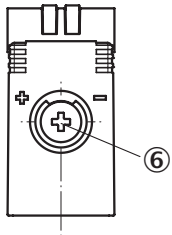

⑥ Adjustment of sensing range

### Dimensional drawing (Dimensions in mm (inch))



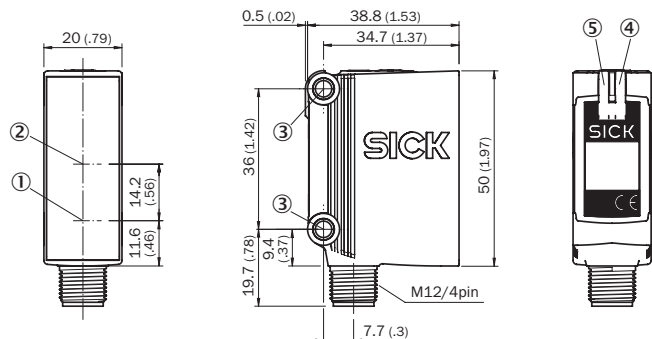

GTE10, GL10, GL10G, DC, connector



- ① Center of optical axis, sender
- ② Center of optical axis, receiver
- ③ Mounting hole, Ø 4.2 mm
- ④ LED indicator yellow: Status of received light beam
- ⑤ LED indicator green: power on

### Recommended accessories

Other models and accessories → [www.sick.com/G10](http://www.sick.com/G10)

|   | Brief description   | Type               | Part no. |
|---|---|--------------------|----------|
| <b>Universal bar clamp systems</b>  |   |                    |          |
|  | Q-Lock, bar clamp system for G10 and reflector P250, Die-cast zinc, steel, zinc coated  | BEF-KHSQ12R01      | 2071260  |
| <b>Mounting brackets and plates</b>   |   |                    |          |
|  | Universal mounting bracket for reflectors, steel, zinc coated   | BEF-WN-REFX        | 2064574  |
| <b>Plug connectors and cables</b>   |   |                    |          |
|  | Head A: female connector, M12, 4-pin, straight, A-coded<br>Head B: Flying leads<br>Cable: Sensor/actuator cable, PVC, unshielded, 5 m | YF2A14-050VB3XLEAX | 2096235  |
|  | Head A: male connector, M12, 4-pin, straight<br>Head B: -<br>Cable: unshielded  | STE-1204-G         | 6009932  |
| <b>Reflectors</b>   |   |                    |          |
|  | Rectangular, screw connection, 51 mm x 61 mm, PMMA/ABS, Screw-on, 2 hole mounting   | P250               | 5304812  |

## SICK AT A GLANCE

SICK is one of the leading manufacturers of intelligent sensors and sensor solutions for industrial applications. A unique range of products and services creates the perfect basis for controlling processes securely and efficiently, protecting individuals from accidents and preventing damage to the environment.

We have extensive experience in a wide range of industries and understand their processes and requirements. With intelligent sensors, we can deliver exactly what our customers need. In application centers in Europe, Asia and North America, system solutions are tested and optimized in accordance with customer specifications. All this makes us a reliable supplier and development partner.

Comprehensive services complete our offering: SICK LifeTime Services provide support throughout the machine life cycle and ensure safety and productivity.

For us, that is “Sensor Intelligence.”

## WORLDWIDE PRESENCE:

Contacts and other locations –[www.sick.com](http://www.sick.com)