



RFH630-1000001

RFH6xx

RFID

**SICK**  
Sensor Intelligence.



### Ordering information

Type	Part no.
RFH630-1000001	1054747

Other models and accessories → [www.sick.com/RFH6xx](http://www.sick.com/RFH6xx)



### Detailed technical data

#### Features

<b>Version</b>	Mid Range
<b>Product category</b>	RFID read/write device with integrated antenna
<b>Radio approval</b>	Global
<b>Frequency band</b>	HF (13.56 MHz)
<b>Carrier frequency</b>	13.56 MHz
<b>Output power</b>	1 W
<b>RFID standard</b>	ISO/IEC 15693, ISO/IEC 18000-3 "Mode 1"
<b>Connection type</b>	Cable
<b>Read range</b>	≤ 240 mm <sup>1)</sup>
<b>Antenna</b>	Integrated
<b>Transmitting power</b>	1 W
<b>Typical access times</b>	UID read (64 bits/8 bytes): 18 ms Read 1 block (32 bit/4 Byte): 13 ms Write 1 block (32 bit/4 Byte): 16 ms Read 28 blocks (896 bit/112 Byte): 64 ms Write 28 blocks (896 bit/112 Byte): 442 ms
<b>Air interface data transmission rate</b>	26 kbit/s (default)

<sup>1)</sup> With RFID ISO card transponder in plane parallel alignment to read/write device antenna; depending on dimensions and quality of transponder.

#### Mechanics/electronics

<b>Connection type</b>	1 x cable, 15-pin D-Sub HD male connector
<b>Supply voltage</b>	10 V DC ... 30 V DC
<b>Power consumption</b>	Typ. 8 W
<b>Housing</b>	Aluminum die cast Plastic (PPS)

<b>Housing color</b>	Blue, black
<b>Enclosure rating</b>	IP67
<b>Protection class</b>	III
<b>Weight</b>	+ 760 g, with connecting cable
<b>Dimensions (L x W x H)</b>	147 mm x 88 mm x 39 mm
<b>MTBF</b>	> 100 years

## Interfaces

<b>PROFINET</b>	✓
Type of fieldbus integration	Optional over external fieldbus module CDF600-2
Function	PROFINET Single Port, PROFINET Dual Port, Host
<b>EtherCAT</b>	✓
Type of fieldbus integration	Optional over external fieldbus module CDF600
Function	Host
<b>Serial</b>	✓, RS-232, RS-422, RS-485
Remark	RS-422/RS-485 only via 4-wire
Function	Host, AUX
Data transmission rate	0.3 kBaud ... 115.2 kBaud, AUX: 57.6 kBaud
<b>CAN</b>	✓
Remark	CSN (SICK CAN Sensor Network)
Function	Host
Data transmission rate	20 kbit/s ... 1,000 kbit/s
<b>CANopen</b>	✓
Function	Host
Data transmission rate	20 kbit/s ... 1,000 kbit/s
<b>PROFIBUS DP</b>	✓
Type of fieldbus integration	Optional over external fieldbus module CDF600-2
Function	Host
<b>Digital inputs</b>	2 (physical, 2 additional logical inputs via optional CMC600 parameter memory in CD-B620 / CDM420)
<b>Digital outputs</b>	2 (physical, 2 additional logical outputs via optional CMC600 parameter memory in CD-B620 / CDM420)
<b>Optical indicators</b>	6 LEDs, multi-color (device status) 1 RGB LED (Process feedback)
<b>Acoustic indicators</b>	1 beeper (Feedback)
<b>Configuration software</b>	SOPAS ET <sup>1)</sup>
<b>Memory card</b>	microSD memory card (parameter cloning)

<sup>1)</sup> Another alternative is to generate your own configuration tools based on the SICK command language CoLa (e.g. in your own software or on PLC function blocks).

## Ambient data

<b>Electromagnetic compatibility (EMC)</b>	EN 301489-3
<b>Vibration resistance</b>	EN 60068-2-64:2008-02
<b>Shock resistance</b>	EN 60068-2-27:2009-05
<b>Ambient operating temperature</b>	-20 °C ... +50 °C

<b>Storage temperature</b>	-25 °C ... +70 °C
<b>Permissible relative humidity</b>	95 %, Non-condensing

## Classifications

<b>eCl@ss 5.0</b>	27280401
<b>eCl@ss 5.1.4</b>	27280401
<b>eCl@ss 6.0</b>	27280401
<b>eCl@ss 6.2</b>	27280401
<b>eCl@ss 7.0</b>	27280401
<b>eCl@ss 8.0</b>	27280401
<b>eCl@ss 8.1</b>	27280401
<b>eCl@ss 9.0</b>	27280401
<b>eCl@ss 10.0</b>	27280401
<b>eCl@ss 11.0</b>	27280401
<b>eCl@ss 12.0</b>	27280401
<b>ETIM 6.0</b>	EC002998
<b>ETIM 7.0</b>	EC002998
<b>ETIM 8.0</b>	EC002998
<b>UNSPSC 16.0901</b>	52161523

## Dimensional drawing (Dimensions in mm (inch))

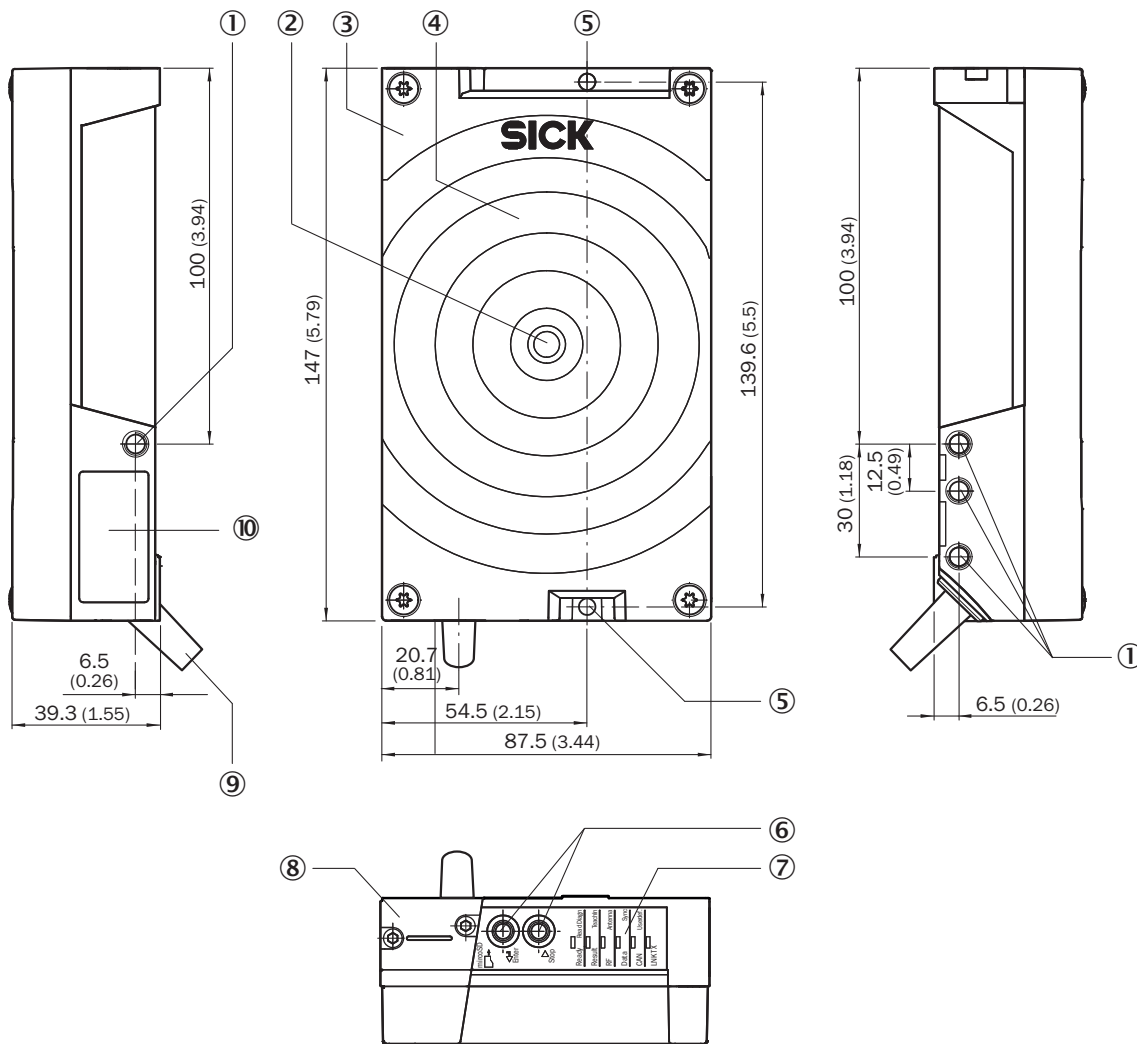

- ① 4 x M6 blind tapped holes, 6.5 mm deep for mounting the device
- ② 1 x RGB LED, multi-colored (process feedback)
- ③ Cover with integrated antenna
- ④ Position of the beeper under the antenna cover
- ⑤ 2 x mounting hole  $\varnothing$  4.5 mm, for alternative mounting of the device
- ⑥ Function button (2 x)
- ⑦ 6 x RGB LED, multi-colored (status indicators)
- ⑧ Slot for microSD memory card
- ⑨ Cable (0.9 m) permanently attached to device with male connector, D-Sub-HD, 15-pin (connection "Power/Serial Data/CAN/I/O")
- ⑩ Type label

### Reading field diagram

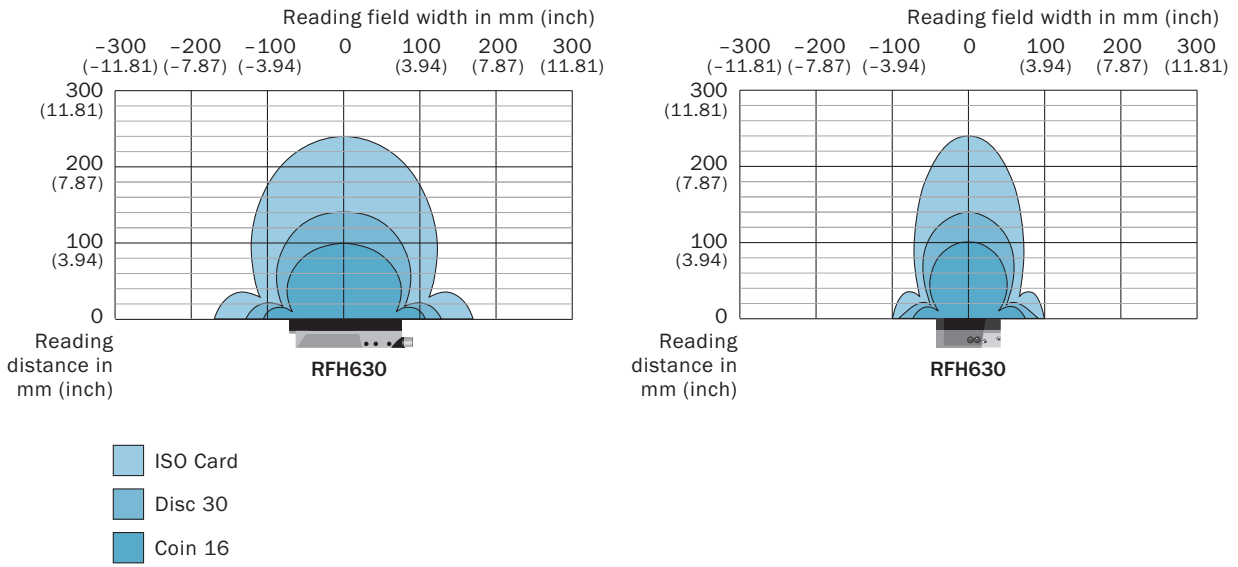

### Assembly note

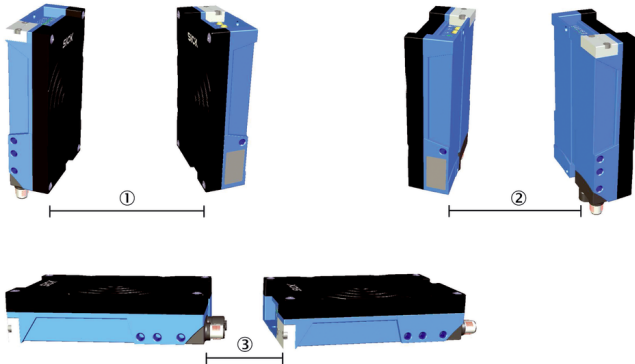

Distances required to prevent mutual interference with mounting of two devices.

Product type	1	2	3
RFH620 Short Range	340 mm	140 mm	150 mm
RFH630 Mid Range	1,700 mm	1,200 mm	1,300 mm

## Connection diagram

### PROFINET IO/RT

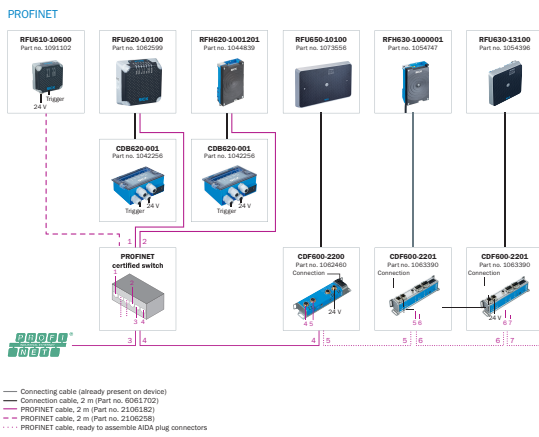

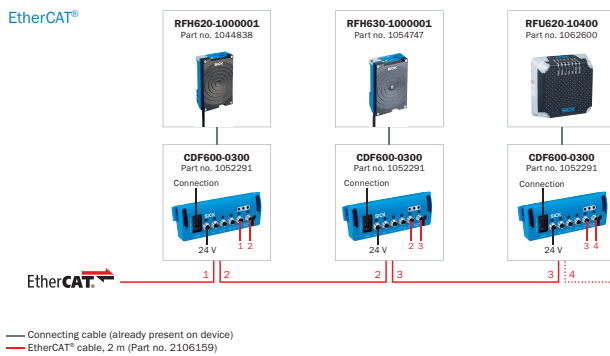

### EtherCAT®



## Recommended accessories

Other models and accessories → [www.sick.com/RFH6xx](http://www.sick.com/RFH6xx)

	Brief description	Type	Part no.
<b>Mounting brackets and plates</b>			
	Mounting bracket, mounting hardware included	Mounting bracket	2048551
<b>Others</b>			
	<ul style="list-style-type: none"> <li>• <b>Carrier frequency:</b> 13.56 MHz</li> <li>• <b>Memory capacity (UII / user memory):</b> 896 Bit (28 x 4 Byte)</li> <li>• <b>Dimensions (L x W x H):</b> 49 mm x 81 mm x 0.42 mm</li> </ul>	HF transponder, paper label	6037763

	Brief description	Type	Part no.
Modules			
	<ul style="list-style-type: none"> <li>• <b>Sub product family:</b> CDB620</li> <li>• <b>Supported products:</b> CLV61x - CLV65x, Lector62x, RFH6xx, RFU62x</li> <li>• <b>Brief description:</b> Small connection module for one sensor, 4 cable glands, base for CMC600</li> </ul>	CDB620-001	1042256

## Recommended services

Additional services → [www.sick.com/RFH6xx](http://www.sick.com/RFH6xx)

	Type	Part no.
Maintenance		
<ul style="list-style-type: none"> <li>• <b>Product area:</b> RFID</li> <li>• <b>Range of services:</b> Inspection, analysis and restoring of defined functions, Checking and adjustment of reading configuration, data processing, network, interfaces and inputs and outputs as well as operating data</li> <li>• <b>Duration:</b> Additional work will be invoiced separately</li> <li>• <b>Travel expenses:</b> The prices do not include travel costs such as hotel, flight, travel time and expenses.</li> </ul>	Maintenance RFU/RFH	1611424
Commissioning		
<ul style="list-style-type: none"> <li>• <b>Product area:</b> RFID</li> <li>• <b>Range of services:</b> Inspection of connection, alignment, optimization of parameters of the RFU/RFH as well as tests, Setup of previously defined functions of reading configuration, data processing and network, interfaces and inputs and outputs</li> <li>• <b>Travel expenses:</b> The prices do not include travel costs such as hotel, flight, travel time and expenses.</li> <li>• <b>Duration:</b> Additional work will be invoiced separately</li> </ul>	Commissioning RFU/RFH	1610018
Extended warranty		
<ul style="list-style-type: none"> <li>• <b>Product area:</b> Identification solutions, machine vision, Distance sensors, Detection and ranging solutions</li> <li>• <b>Range of services:</b> The services correspond to the scope of the statutory manufacturer warranty (SICK general terms of delivery).</li> <li>• <b>Duration:</b> Five-year warranty from delivery date.</li> </ul>	Extended warranty for a total of five years from delivery date	1680671

## SICK AT A GLANCE

SICK is one of the leading manufacturers of intelligent sensors and sensor solutions for industrial applications. A unique range of products and services creates the perfect basis for controlling processes securely and efficiently, protecting individuals from accidents and preventing damage to the environment.

We have extensive experience in a wide range of industries and understand their processes and requirements. With intelligent sensors, we can deliver exactly what our customers need. In application centers in Europe, Asia and North America, system solutions are tested and optimized in accordance with customer specifications. All this makes us a reliable supplier and development partner.

Comprehensive services complete our offering: SICK LifeTime Services provide support throughout the machine life cycle and ensure safety and productivity.

For us, that is “Sensor Intelligence.”

## WORLDWIDE PRESENCE:

Contacts and other locations –[www.sick.com](http://www.sick.com)