



# WTB12L-24162120A00

## W12

SMALL PHOTOELECTRIC SENSORS

**SICK**  
Sensor Intelligence.



Illustration may differ



### Ordering information

Type	Part no.
WTF12L-24162120A00	1125923

Other models and accessories → [www.sick.com/W12](http://www.sick.com/W12)

### Detailed technical data

#### Features

<b>Functional principle</b>	Photoelectric proximity sensor
<b>Functional principle detail</b>	Foreground suppression
<b>Sensing range</b>	
Sensing range min.	80 mm
Sensing range max.	350 mm
Adjustable switching threshold for background suppression	100 mm ... 350 mm
Reference object	Object with 90% remission factor (complies with standard white according to DIN 5033)
Minimum object height at set sensing range in front of black background (6% remission factor)	2.2 mm, at a distance of 150 mm
Recommended sensing range for the best performance	100 mm ... 200 mm
<b>Emitted beam</b>	
Light source	Laser
Type of light	Visible red light
Shape of light spot	Ellipse shape
Light spot size (distance)	2.6 mm x 1.2 mm (150 mm)
Maximum dispersion of the emitted beam around the standardized transmission axis (squint angle)	< +/- 1.0° (at Ta = +23 °C)
<b>Key laser figures</b>	
Normative reference	EN 60825-1:2014, IEC 60825-1:2014

Laser class	1
Wave length	655 nm
Pulse duration	4 $\mu$ s
Maximum pulse power	< 6.74 mW
Average service life	50,000 h at $T_U = +25$ °C
<b>Smallest detectable object (MDO) typ.</b>	2.5 mm (at a distance of 200 mm) Object with 90% remission factor (complies with standard white according to DIN 5033)
<b>Adjustment</b>	
Teach-Turn adjustment	BluePilot: For setting the sensing range
IO-Link	For configuring the sensor parameters and Smart Task functions
<b>Indication</b>	
LED blue	BluePilot: sensing range indicator
LED green	Operating indicator Static on: power on Flashing: IO-Link mode
LED yellow	Status of received light beam Static on: object present Static off: object not present
<b>Special applications</b>	Detecting small objects, Detection of objects moving at high speeds, Detecting flat objects, Detecting perforated objects

### Safety-related parameters

<b>MTTF<sub>D</sub></b>	280 years
<b>DC<sub>avg</sub></b>	0 %
<b>T<sub>M</sub> (mission time)</b>	10 years (EN ISO 13849) Rate of use: 60 %

### Communication interface

<b>Communication interface</b>	IO-Link V1.1
<b>Communication Interface detail</b>	COM2 (38,4 kBaud)
<b>Cycle time</b>	2.3 ms
<b>Process data length</b>	16 Bit
<b>Process data structure</b>	Bit 0 = switching signal Q <sub>L1</sub> Bit 1 = switching signal Q <sub>L2</sub> Bit 2 ... 15 = Current receiver level (live)
<b>VendorID</b>	26
<b>DeviceID HEX</b>	0x8002CE
<b>DeviceID DEC</b>	8389326
<b>Compatible master port type</b>	A
<b>SIO mode support</b>	Yes

### Electrical data

<b>Supply voltage U<sub>B</sub></b>	10 V DC ... 30 V DC <sup>1)</sup>
-------------------------------------	-----------------------------------

<sup>1)</sup> Limit values.

<sup>2)</sup> Signal transit time with resistive load in switching mode.

<sup>3)</sup> With light/dark ratio 1:1.

<b>Ripple</b>	≤ 5 V
<b>Usage category</b>	DC-12 (According to EN 60947-5-2) DC-13 (According to EN 60947-5-2)
<b>Current consumption</b>	≤ 14 mA, without load. At $U_B = 24\text{ V}$
<b>Protection class</b>	III
<b>Digital output</b>	
Number	2 (Complementary)
Type	Push-pull: PNP/NPN
Signal voltage PNP HIGH/LOW	Approx. $U_B - 2.5\text{ V} / 0\text{ V}$
Signal voltage NPN HIGH/LOW	Approx. $U_B / < 2.5\text{ V}$
Output current $I_{\text{max}}$	≤ 100 mA
Circuit protection outputs	Reverse polarity protected Overcurrent protected Short-circuit protected
Response time	≤ 500 $\mu\text{s}$ <sup>2)</sup>
Repeatability (response time)	150 $\mu\text{s}$ <sup>2)</sup>
Switching frequency	1,000 Hz <sup>3)</sup>
<b>Pin/Wire assignment</b>	
BN 1	+ (L+)
WH 2	$\bar{Q}_{L1}$ /MF Digital output, dark switching, object present → output $\bar{Q}_{L1}$ HIGH The pin 2 function of the sensor can be configured Additional possible settings via IO-Link
BU 3	- (M)
BK 4	QL1/C Digital output, light switching, object present → output $Q_{L1}$ LOW The pin 4 function of the sensor can be configured Additional possible settings via IO-Link

<sup>1)</sup> Limit values.

<sup>2)</sup> Signal transit time with resistive load in switching mode.

<sup>3)</sup> With light/dark ratio 1:1.

## Mechanical data

<b>Housing</b>	Rectangular
<b>Dimensions (W x H x D)</b>	15.6 mm x 49.5 mm x 43.1 mm
<b>Connection</b>	Male connector M12, 4-pin
<b>Material</b>	
Housing	Metal, zinc diecast
Front screen	Plastic, PMMA
Male connector	Plastic, VISTAL®
<b>Weight</b>	Approx. 77 g
<b>Maximum tightening torque of the fixing screws</b>	1.4 Nm

## Ambient data

<b>Enclosure rating</b>	IP66 (EN 60529) IP67 (EN 60529)
-------------------------	------------------------------------

	IP69 (EN 60529)
<b>Ambient operating temperature</b>	-20 °C ... +55 °C
<b>Ambient temperature, storage</b>	-40 °C ... +70 °C
<b>Warm-up time</b>	< 15 min, Where $T_u$ is under -10 °C
<b>Typ. Ambient light immunity</b>	Artificial light: $\leq 50,000$ lx Sunlight: $\leq 50,000$ lx
<b>Shock resistance</b>	50 g, 11 ms (25 positive and 25 negative shocks along X, Y, Z axes, 150 total shocks (EN60068-2-27))
<b>Vibration resistance</b>	10 Hz ... 2,000 Hz (Amplitude 0.5 mm / 10 g, 20 sweeps per axis, for X, Y, Z axes, 1 octave/min, (EN60068-2-6))
<b>Air humidity</b>	35 % ... 95 %, Relative humidity (no condensation)
<b>Electromagnetic compatibility (EMC)</b>	EN 60947-5-2
<b>Resistance to cleaning agent</b>	ECOLAB
<b>UL File No.</b>	NRKH.E181493 & NRKH7.E181493

### Smart Task

<b>Smart Task name</b>	Base logics
<b>Logic function</b>	Direct AND OR
<b>Timer function</b>	Deactivated On delay Off delay ON and OFF delay Impulse (one shot)
<b>Inverter</b>	Yes
<b>Switching frequency</b>	SIO Logic: 900 Hz <sup>1)</sup> IOL: 800 Hz <sup>2)</sup>
<b>Response time</b>	IOL: 600 $\mu$ s <sup>2)</sup>
<b>Repeatability</b>	SIO Logic: 200 $\mu$ s <sup>1)</sup> IOL: 250 $\mu$ s <sup>2)</sup>
<b>Switching signal</b>	
Switching signal $Q_{L1}$	Switching output
Switching signal $\bar{Q}_{L1}$	Switching output

<sup>1)</sup> Use of Smart Task functions without IO-Link communication (SIO mode).

<sup>2)</sup> Use of Smart Task functions with IO-Link communication function.

### Diagnosis

<b>Device temperature</b>	
Measuring range	Very cold, cold, moderate, warm, hot
<b>Device status</b>	Yes
<b>Detailed device status</b>	Yes
<b>Operating hour counter</b>	Yes
<b>Operating hours counter with reset function</b>	Yes
<b>Quality of teach</b>	Yes

### Classifications

<b>eCl@ss 5.0</b>	27270904
-------------------	----------

<b>eCl@ss 5.1.4</b>	27270904
<b>eCl@ss 6.0</b>	27270904
<b>eCl@ss 6.2</b>	27270904
<b>eCl@ss 7.0</b>	27270904
<b>eCl@ss 8.0</b>	27270904
<b>eCl@ss 8.1</b>	27270904
<b>eCl@ss 9.0</b>	27270904
<b>eCl@ss 10.0</b>	27270904
<b>eCl@ss 11.0</b>	27270904
<b>eCl@ss 12.0</b>	27270903
<b>ETIM 5.0</b>	EC002719
<b>ETIM 6.0</b>	EC002719
<b>ETIM 7.0</b>	EC002719
<b>ETIM 8.0</b>	EC002719
<b>UNSPSC 16.0901</b>	39121528

### Connection type

M12 male connector, 4-pin

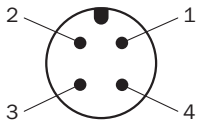

### Truth table

Push-pull: PNP/NPN - light switching Q

	Light switching Q (normally closed (upper switch), normally open (lower switch))	
	Object not present → Output HIGH	Object present → Output LOW
Light receive	☑	☒
Light receive indicator	☑	☒
Load resistance to L+	☒	⚠
Load resistance to M	⚠	☒

PNP Load Connection

NPN Load Connection

Push-pull: PNP/NPN – dark switching  $\bar{Q}$

	Dark switching $\bar{Q}$ (normally open (upper switch), normally closed (lower switch))	
	Object not present → Output LOW	Object present → Output HIGH
Light receive	✓	✗
Light receive indicator	☀️	✗
Load resistance to L+	⚠️	✗
Load resistance to M	✗	⚠️

  

Characteristic curve

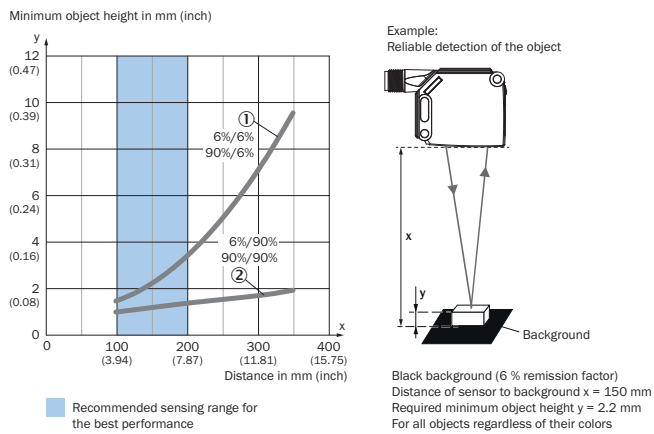

- ① Black background, 6% remission factor
- ② White background, 90% remission factor

Light spot size

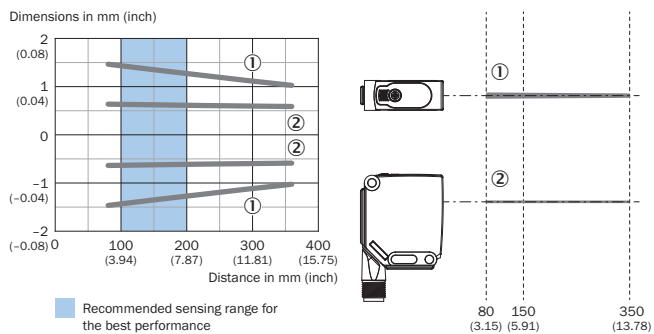

- ① Light spot horizontal
- ② Light spot vertical

### Sensing range diagram

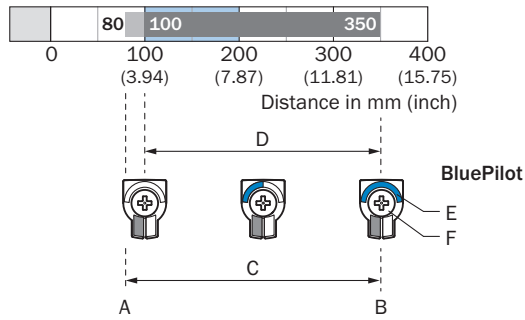

Recommended sensing range for the best performance

A	Sensing range min. in mm
B	Sensing range max. in mm
C	Field of view
D	Adjustable switching threshold for background suppression
E	Sensing range indicator
F	Teach-Turn adjustment

### Adjustments

Display and adjustment elements

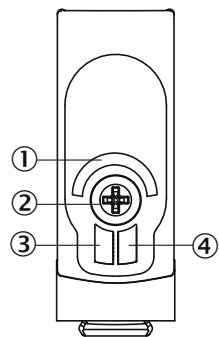

- ① LED blue
- ② Teach-Turn adjustment
- ③ LED green
- ④ LED yellow



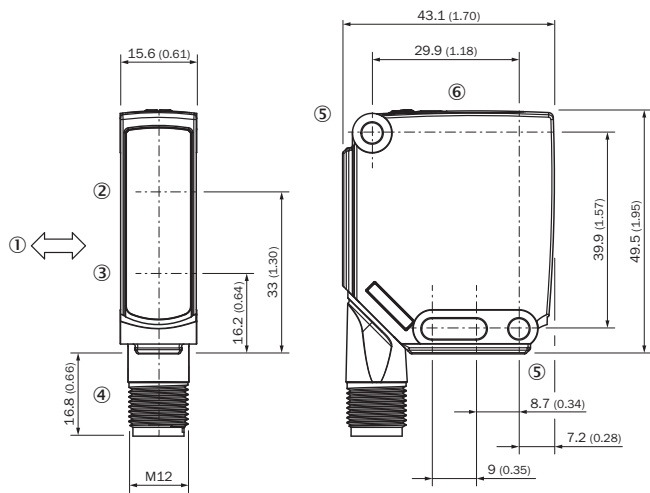

**Dimensional drawing** (Dimensions in mm (inch))





- ① Standard direction of the material being detected
- ② Center of optical axis, receiver
- ③ Center of optical axis, sender
- ④ Connection
- ⑤ Mounting hole,  $\varnothing$  4.2 mm
- ⑥ Display and adjustment elements

**Recommended accessories**

Other models and accessories → [www.sick.com/W12](http://www.sick.com/W12)

	<b>Brief description</b>	<b>Type</b>	<b>Part no.</b>
<b>Universal bar clamp systems</b>			
	Plate N03 for universal clamp bracket, zinc coated, Zinc plated steel (sheet), Zinc die cast (clamping bracket), Universal clamp (5322626), mounting hardware	BEF-KHS-N03	2051609
	Mounting bar, straight, 300 mm, steel, steel, zinc coated, without mounting hardware	BEF-MS12G-B	4056055
	Bar clamp for bar diameter of 12 mm (fixing the mounting rod), Aluminum, 2 screws M6 x 30, 2 spring discs	BEF-RMC-D12	5321878
<b>Mounting brackets and plates</b>			
	Mounting bracket, large, stainless steel, mounting hardware included	BEF-WG-W12	2013942
	BEF-AP-W12	BEF-AP-W12	2127742
<b>Plug connectors and cables</b>			
	Head A: female connector, M12, 4-pin, straight, A-coded Head B: Flying leads Cable: Sensor/actuator cable, PVC, unshielded, 5 m	YF2A14-050VB3XLEAX	2096235

	Brief description	Type	Part no.
Terminal and alignment brackets			
	Clamping block for dovetail mounting, Aluminum (anodised), mounting hardware included	BEF-KH-W12	2013285
Sensor Integration Gateway			
	<ul style="list-style-type: none"> <li>• <b>Further functions:</b> Web server integrated, IIoT interface available (dual talk)</li> <li>• <b>Logic editor:</b> no</li> <li>• <b>Communication interface:</b> IO-Link, Ethernet, PROFINET, REST API, MQTT, OPC UA</li> <li>• <b>Product category:</b> IO-Link Master</li> </ul>	SIG350-0004AP100	6076871

## SICK AT A GLANCE

SICK is one of the leading manufacturers of intelligent sensors and sensor solutions for industrial applications. A unique range of products and services creates the perfect basis for controlling processes securely and efficiently, protecting individuals from accidents and preventing damage to the environment.

We have extensive experience in a wide range of industries and understand their processes and requirements. With intelligent sensors, we can deliver exactly what our customers need. In application centers in Europe, Asia and North America, system solutions are tested and optimized in accordance with customer specifications. All this makes us a reliable supplier and development partner.

Comprehensive services complete our offering: SICK LifeTime Services provide support throughout the machine life cycle and ensure safety and productivity.

For us, that is “Sensor Intelligence.”

## WORLDWIDE PRESENCE:

Contacts and other locations –[www.sick.com](http://www.sick.com)