



# CLV632-6000

CLV63x

**FIXED MOUNT BARCODE SCANNERS**

**SICK**  
Sensor Intelligence.



### Ordering information

| Type        | Part no. |
|-------------|----------|
| CLV632-6000 | 1041996  |

Other models and accessories → [www.sick.com/CLV63x](http://www.sick.com/CLV63x)



### Detailed technical data

#### Features

|                                     |  |
|-------------------------------------|--|
| <b>Version</b>                      | Short Range  |
| <b>Connection type</b>              | Cable  |
| <b>Reading field</b>                | Oscillating mirror   |
| <b>Sensor type</b>                  | Line scanner   |
| <b>Optical focus</b>                | Fixed focus  |
| <b>Light source</b>                 | Light spot, laser, Visible, Red, 655 nm  |
| <b>Light spot</b>                   | Circular   |
| <b>Laser class</b>                  | 2 (IEC 60825-1:2014, EN 60825-1:2014)  |
| <b>Aperture angle</b>               | ≤ 50°  |
| <b>Reading distance</b>             | 45 mm ... 245 mm <sup>1)</sup>   |
| <b>Scanning frequency</b>           | 400 Hz ... 1,200 Hz  |
| <b>Code resolution</b>              | 0.2 mm ... 0.5 mm  |
| <b>Oscillating mirror functions</b> | Fixed (adjustable position), oscillating (variable or fixed amplitude), one shot |
| Oscillation frequency               | 0.5 Hz ... 6.25 Hz   |
| Angle of deflection                 | -20° ... 20°   |

<sup>1)</sup> For details see reading field diagram.

#### Mechanics/electronics

|                          |  |
|--------------------------|--|
| <b>Connection type</b>   | 1 x 15-pin D-Sub HD male connector (0.9 m) |
| <b>Supply voltage</b>    | 18 V DC ... 30 V DC                        |
| <b>Power consumption</b> | 6 W  |
| <b>Housing</b>           | Aluminum die cast                          |
| <b>Housing color</b>     | Light blue (RAL 5012)                      |

<sup>1)</sup> At 25 °C.

|                               |                                      |
|-------------------------------|--------------------------------------|
| <b>Window material</b>        | Glass                                |
| <b>Enclosure rating</b>       | IP65 (EN 60529)                      |
| <b>Protection class</b>       | III (EN 61140)                       |
| <b>Weight</b>                 | 420 g, with connecting cable         |
| <b>Dimensions (L x W x H)</b> | 95 mm x 107 mm x 41 mm               |
| <b>MTBF</b>                   | 100,000 h                            |
| <b>MTTF</b>                   | 40,000 h (Laser diode) <sup>1)</sup> |

<sup>1)</sup> At 25 °C.

### Performance

|   |   |
|---|---|
| <b>Readable code structures</b>               | 1D codes  |
| <b>Bar code types</b>                         | All current code types, Code 39, Code 128, Code 93, Codabar, GS1-128 / EAN 128, UPC / GTIN / EAN, Interleaved 2 of 5, Pharmacode, GS1 DataBar, Telepen, MSI/Plessey |
| <b>Code printing process</b>                  | Label (printed codes)   |
| <b>Print ratio</b>                            | 2:1 ... 3:1   |
| <b>No. of codes per scan</b>                  | 1 ... 20 (Standard decoder)<br>1 ... 6 (SMART decoder)  |
| <b>No. of codes per reading interval</b>      | 1 ... 50 (auto-discriminating)  |
| <b>No. of characters per reading interval</b> | 5,000<br>500 (for multiplexer function in CAN operation)  |
| <b>No. of multiple readings</b>               | 1 ... 99  |

### Interfaces

|                              |  |
|------------------------------|--|
| <b>PROFINET</b>              | ✓  |
| Type of fieldbus integration | Optional over external fieldbus module CDF600-2  |
| Function                     | PROFINET Single Port, PROFINET Dual Port   |
| <b>EtherCAT</b>              | ✓  |
| Type of fieldbus integration | Optional over external fieldbus module CDF600  |
| <b>Serial</b>                | ✓, RS-232, RS-422, RS-485  |
| Function                     | Host, AUX  |
| Data transmission rate       | 2,400 Baud ... 115.2 kBaud, AUX: 57.6 kBaud (RS-232)   |
| <b>CAN</b>                   | ✓  |
| Function                     | SICK CAN sensor network CSN (CAN controller/CAN device, multiplexer/server)                  |
| Data transmission rate       | 20 kbit/s ... 1 Mbit/s   |
| <b>CANopen</b>               | ✓  |
| Data transmission rate       | 20 kbit/s ... 1 Mbit/s   |
| <b>PROFIBUS DP</b>           | ✓  |
| Type of fieldbus integration | Optional over external fieldbus module CDF600-2  |
| <b>Digital inputs</b>        | 4 ("Sensor 1", "Sensor 2", 2 inputs via optional parameter storage CMC600 in CDB620/CDM420)  |
| <b>Digital outputs</b>       | 4 ("Result 1", "Result 2", 2 outputs via optional parameter storage CMC600 in CDB620/CDM420) |
| <b>Reading pulse</b>         | Digital inputs, non-powered, serial interface, auto pulse, CAN                               |
| <b>Optical indicators</b>    | 6 LEDs (Ready)<br>, Result<br>, laser<br>, Data  |

|                               |   |
|-------------------------------|---|
|                               | , CAN<br>, LNK TX<br>, Bar graph for displaying the reading rate percentage (10 LEDs) |
| <b>Acoustic indicators</b>    | Beeper/buzzer (can be switched off, can be allocated as a result indication function) |
| <b>Control elements</b>       | 2 buttons (choose and start/stop functions)   |
| <b>Configuration software</b> | SOPAS ET  |
| <b>Memory card</b>            | MicroSD memory card (flash card), optional  |

#### Ambient data

|  |  |
|--|--|
| <b>Electromagnetic compatibility (EMC)</b> | EN 61000-6-3 (2001-10) / EN 61000-6-2:2005 |
| <b>Vibration resistance</b>                | EN 60068-2-6 (1995)                        |
| <b>Shock resistance</b>                    | EN 60068-2-27 (1993)                       |
| <b>Ambient operating temperature</b>       | 0 °C ... +40 °C                            |
| <b>Storage temperature</b>                 | -20 °C ... +70 °C                          |
| <b>Permissible relative humidity</b>       | 90 %, Non-condensing                       |
| <b>Ambient light immunity</b>              | 2,000 lx, on barcode                       |
| <b>Bar code print contrast (PCS)</b>       | ≥ 60 %                                     |

#### General notes

|                    |  |
|--------------------|--|
| <b>Note on use</b> | For Ethernet connection please use an Ethernet version of CLV6xx |
|--------------------|--|

#### Classifications

|                       |          |
|-----------------------|----------|
| <b>eCl@ss 5.0</b>     | 27280102 |
| <b>eCl@ss 5.1.4</b>   | 27280102 |
| <b>eCl@ss 6.0</b>     | 27280102 |
| <b>eCl@ss 6.2</b>     | 27280102 |
| <b>eCl@ss 7.0</b>     | 27280102 |
| <b>eCl@ss 8.0</b>     | 27280102 |
| <b>eCl@ss 8.1</b>     | 27280102 |
| <b>eCl@ss 9.0</b>     | 27280102 |
| <b>eCl@ss 10.0</b>    | 27280102 |
| <b>eCl@ss 11.0</b>    | 27280102 |
| <b>eCl@ss 12.0</b>    | 27280102 |
| <b>ETIM 5.0</b>       | EC002550 |
| <b>ETIM 6.0</b>       | EC002550 |
| <b>ETIM 7.0</b>       | EC002550 |
| <b>ETIM 8.0</b>       | EC002550 |
| <b>UNSPSC 16.0901</b> | 43211701 |

Dimensional drawing (Dimensions in mm (inch))

CLV63x/64x/65x Standard, oscillating mirror

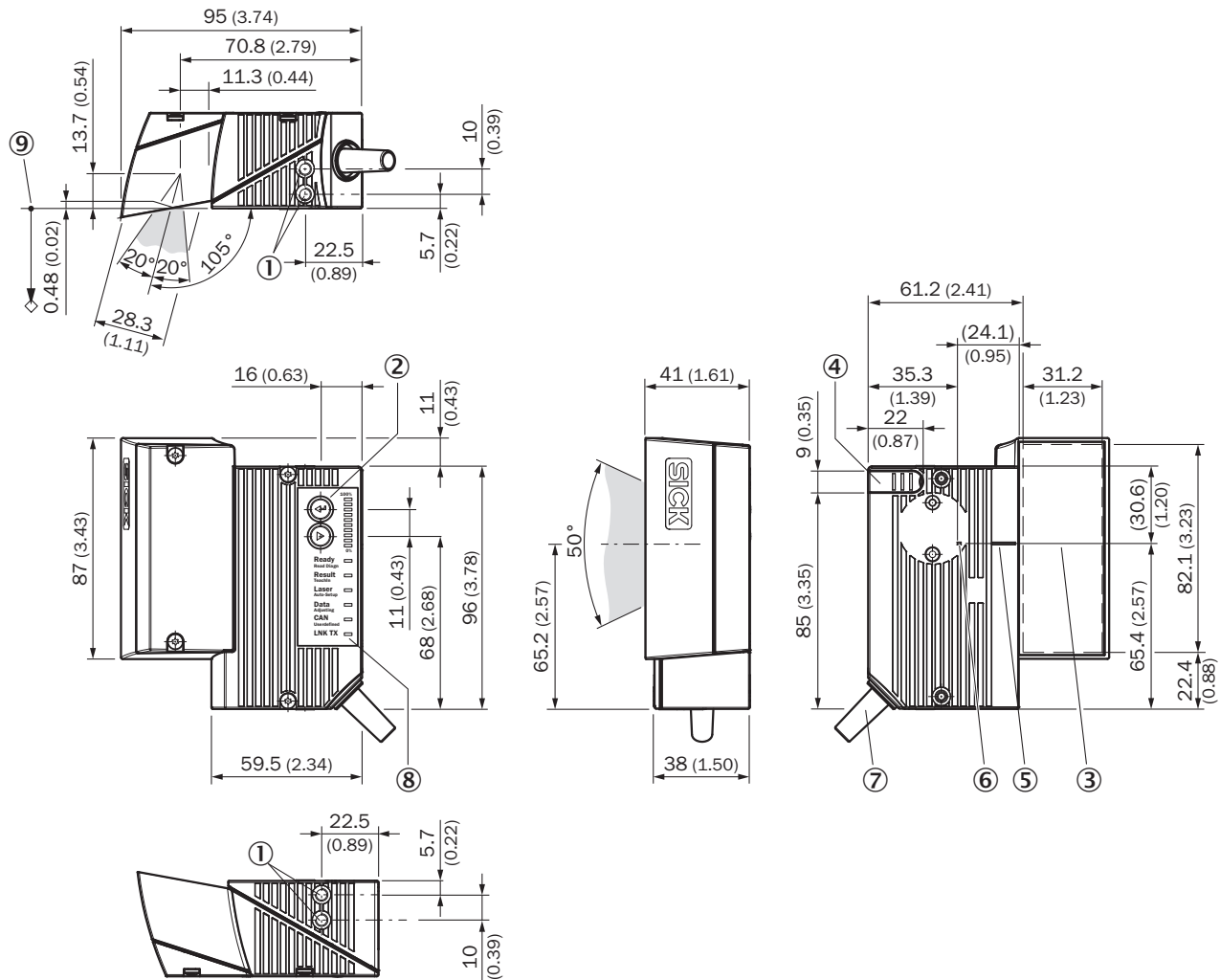

- ① Blind hole thread M5, 5 mm deep (2 x), for mounting
- ② Function button (2 x)
- ③ Reading field
- ④ Cover for the microSD memory card
- ⑤ Central position of the deflected laser beam in the V-shaped aperture angle
- ⑥ Internal impact point: rotation point of the variable direction laser beam
- ⑦ Cable with 15-pin D-sub HD male connector
- ⑧ LED status indicator (6x) and bar graph
- ⑨ Reference point for reading distance (from housing edge to object)

**Reading field diagram**

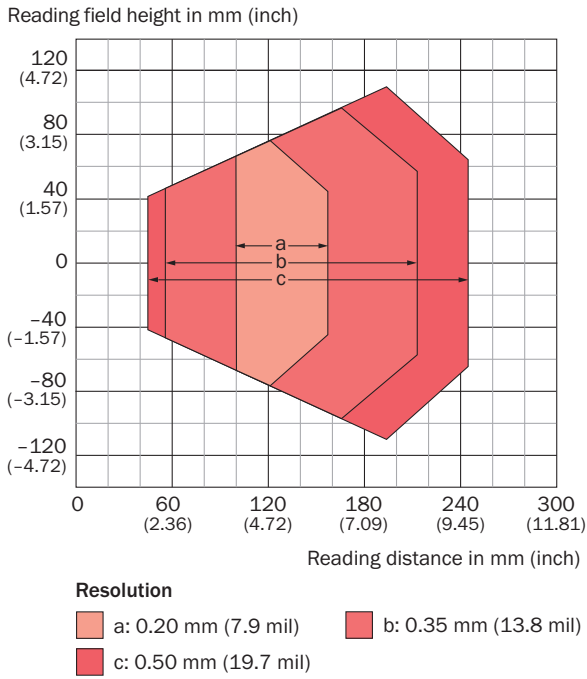



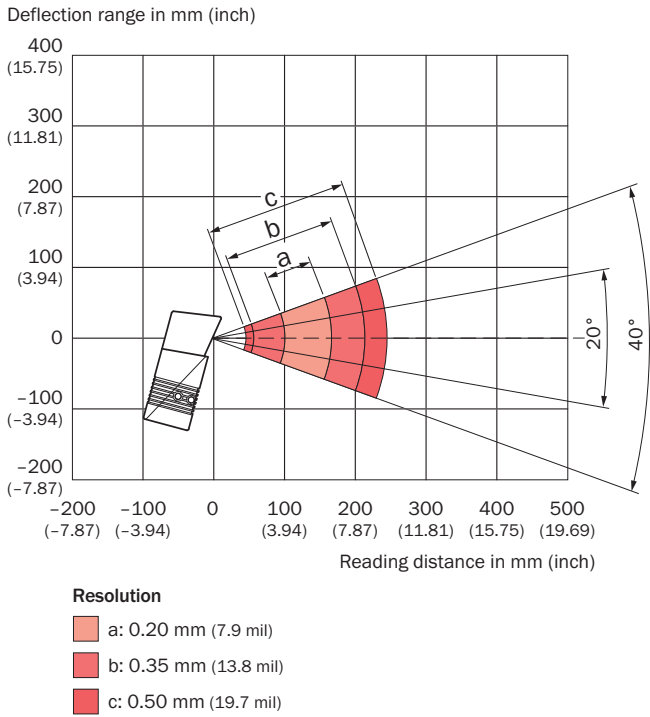

**Deflection width**



## Recommended accessories

Other models and accessories → [www.sick.com/CLV63x](http://www.sick.com/CLV63x)

|   | Brief description   | Type                | Part no. |
|---|---|---------------------|----------|
| <b>Cloning module</b>   |   |                     |          |
|  | External parameter memory for integration in CDB620/CDB650/CDM42x   | CMC600-101          | 1042259  |
| <b>Storage media</b>  |   |                     |          |
|  | microSD memory card with 1 GB for industrial use  | microSD memory card | 4051366  |
| <b>Mounting brackets and plates</b>   |   |                     |          |
|  | Hanger-shaped mounting bracket, mounting hardware included  | Mounting bracket    | 2042800  |
| <b>Modules</b>  |   |                     |          |
|  | <ul style="list-style-type: none"> <li>• <b>Sub product family:</b> CDB620</li> <li>• <b>Supported products:</b> CLV61x - CLV65x, Lector62x, RFH6xx, RFU62x</li> <li>• <b>Brief description:</b> Small connection module for one sensor, 4 cable glands, base for CMC600</li> </ul> | CDB620-001          | 1042256  |

## Recommended services

Additional services → [www.sick.com/CLV63x](http://www.sick.com/CLV63x)

|   | Type   | Part no. |
|---|--|----------|
| <b>Performance check</b>  |  |          |
| <ul style="list-style-type: none"> <li>• <b>Product area:</b> Fixed mount barcode scanners</li> <li>• <b>Range of services:</b> Inspection of defined functions, e.g., reading performance</li> <li>• <b>Travel expenses:</b> The prices do not include travel costs such as hotel, flight, travel time and expenses.</li> <li>• <b>Duration:</b> Additional work will be invoiced separately</li> </ul>  | Performance check<br>CLV4xx/CLV6xx                             | 1682028  |
| <b>Commissioning</b>  |  |          |
| <ul style="list-style-type: none"> <li>• <b>Product area:</b> Fixed mount barcode scanners</li> <li>• <b>Range of services:</b> Inspection of connection, fine adjustment, optimization of parameters of SICK product as well as tests, Setup of previously defined functions of reading configuration, code configuration, data processing and network, interfaces or inputs and outputs</li> <li>• <b>Travel expenses:</b> The prices do not include travel costs such as hotel, flight, travel time and expenses.</li> <li>• <b>Duration:</b> Additional work will be invoiced separately</li> </ul> | Commissioning<br>CLV61x ... CLV64x                             | 1681925  |
| <b>Extended warranty</b>  |  |          |
| <ul style="list-style-type: none"> <li>• <b>Product area:</b> Identification solutions, machine vision, Distance sensors, Detection and ranging solutions</li> <li>• <b>Range of services:</b> The services correspond to the scope of the statutory manufacturer warranty (SICK general terms of delivery).</li> <li>• <b>Duration:</b> Five-year warranty from delivery date.</li> </ul>  | Extended warranty for a total of five years from delivery date | 1680671  |

## SICK AT A GLANCE

SICK is one of the leading manufacturers of intelligent sensors and sensor solutions for industrial applications. A unique range of products and services creates the perfect basis for controlling processes securely and efficiently, protecting individuals from accidents and preventing damage to the environment.

We have extensive experience in a wide range of industries and understand their processes and requirements. With intelligent sensors, we can deliver exactly what our customers need. In application centers in Europe, Asia and North America, system solutions are tested and optimized in accordance with customer specifications. All this makes us a reliable supplier and development partner.

Comprehensive services complete our offering: SICK LifeTime Services provide support throughout the machine life cycle and ensure safety and productivity.

For us, that is “Sensor Intelligence.”

## WORLDWIDE PRESENCE:

Contacts and other locations –[www.sick.com](http://www.sick.com)