



YM2D24-020EB2MRJA4

SICK
Sensor Intelligence.



Illustration may differ



Ordering information

Type	Part no.
YM2D24-020EB2MRJA4	6050198

Other models and accessories → www.sick.com/

Detailed technical data

Technical specifications

Accessory group	Plug connectors and cables
Accessory family	Connection cables
Connection type head A	Male connector, M12, 4-pin, straight, D-coded
Connection type head B	Male connector, RJ45, 8-pin, straight
Cable	2 m, 4-wire, AWG26
Shielding	Shielded
Signal type	Ethernet
Transmission characteristics	CAT5
Data transmission rate	≤ 100 Mbit/s
Authorizations	Ecolab

Classifications

eCl@ss 5.0	19030312
eCl@ss 5.1.4	19030312
eCl@ss 6.0	27060304
eCl@ss 6.2	27060304
eCl@ss 7.0	27060304
eCl@ss 8.0	27060304
eCl@ss 8.1	27060304
eCl@ss 9.0	27060304
eCl@ss 10.0	27060304
eCl@ss 11.0	27060304
eCl@ss 12.0	27060304
ETIM 5.0	EC000830
ETIM 6.0	EC000830
ETIM 7.0	EC003249
ETIM 8.0	EC003249
UNSPSC 16.0901	26121604

Dimensional drawing (Dimensions in mm (inch))

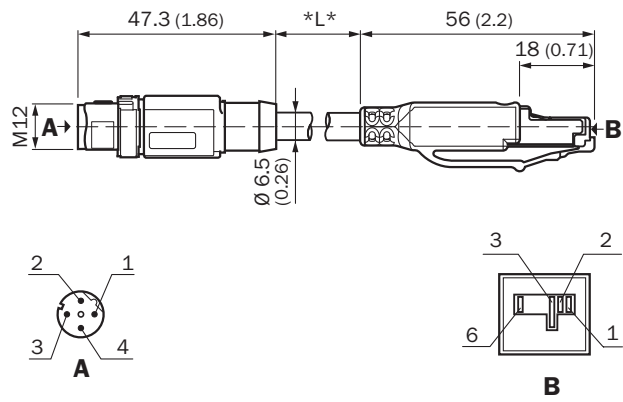

SICK AT A GLANCE

SICK is one of the leading manufacturers of intelligent sensors and sensor solutions for industrial applications. A unique range of products and services creates the perfect basis for controlling processes securely and efficiently, protecting individuals from accidents and preventing damage to the environment.

We have extensive experience in a wide range of industries and understand their processes and requirements. With intelligent sensors, we can deliver exactly what our customers need. In application centers in Europe, Asia and North America, system solutions are tested and optimized in accordance with customer specifications. All this makes us a reliable supplier and development partner.

Comprehensive services complete our offering: SICK LifeTime Services provide support throughout the machine life cycle and ensure safety and productivity.

For us, that is “Sensor Intelligence.”

WORLDWIDE PRESENCE:

Contacts and other locations –www.sick.com