



E100-B2A22S05A

E100

SAFETY COMMAND DEVICES

SICK
Sensor Intelligence.



Ordering information

Type	Part no.
E100-B2A22S05A	6022879

Other models and accessories → www.sick.com/E100



Detailed technical data

Features

Number of positive action N/C contacts	2
Number of N/O contacts	2
Actuation directions	1
Plus/minus button	✓

Safety-related parameters

B_{10d} parameter	5 x 10 ⁵ switching cycles (with small load)
Safe state in the event of a fault	The switch has no internal fault detection and is unable to assume a safe state in the event of a fault. Fault detection is performed by the connected safety-related logic unit.

Functions

Safe series connection	None, only individual wiring (with diagnostics)
-------------------------------	---

Interfaces

Type of connection cable	Straight
Connection type	Cable open end
Length of cable	5 m
Cable diameter	9.8 mm
Conductor cross section	8 x 0.5 mm ² , 8 x 0.14 mm ²
Bend radius (with fixed installation)	> 7.5 x cable diameter
Bend radius (with moving cable)	> 15 x cable diameter
Cable material	PUR
Conductor material	Copper

Electrical data

Switching principle	Slow action switching element
Number of positive action N/C contacts	2
Number of N/O contacts	2
Usage category	DC-13 (EN 60947-5-1)
Rated operating current (voltage)	2 A (24 V DC)

	100 mA (24 V DC)
Rated insulation voltage U_i	32 V
Rated impulse withstand voltage U_{imp}	800 V
Short-circuit protection	2 A gG / 0.1 A gG
Switching voltage	≥ 12 V DC
Switching current (switching voltage)	≥ 1 mA (24 V DC)

Mechanical data

Dimensions	64 mm x 132 mm
Weight	1.32 kg
Housing material	Plastic
Mechanical life	1×10^5 switching cycles

Ambient data

Enclosure rating	IP65 (EN 60529)
Ambient operating temperature	-5 °C ... +50 °C
Storage temperature	-5 °C ... +50 °C

Classifications

eCl@ss 5.0	27371238
eCl@ss 5.1.4	27371238
eCl@ss 6.0	27371238
eCl@ss 6.2	27371238
eCl@ss 7.0	27371238
eCl@ss 8.0	27371238
eCl@ss 8.1	27371238
eCl@ss 9.0	27371238
eCl@ss 10.0	27371238
eCl@ss 11.0	27371238
eCl@ss 12.0	27371238
ETIM 5.0	EC002571
ETIM 6.0	EC002571
ETIM 7.0	EC002571
ETIM 8.0	EC002571
UNSPSC 16.0901	39122205

Dimensional drawing (Dimensions in mm (inch))

E100-B

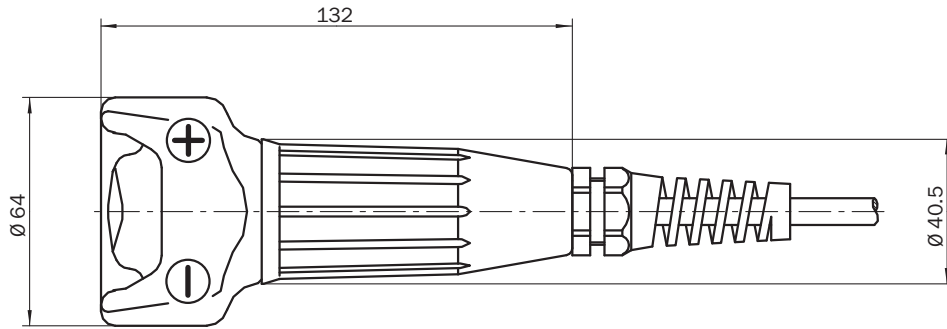

Actuator travel diagram

E100-B

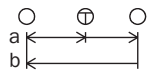
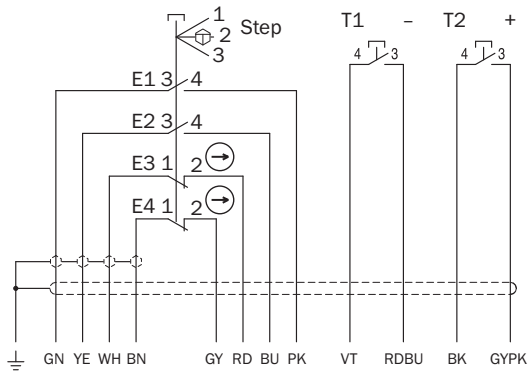

⊕ Trigger point

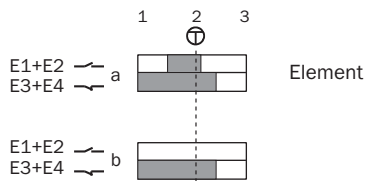

- Contacts open
- Contacts closed

SICK AT A GLANCE

SICK is one of the leading manufacturers of intelligent sensors and sensor solutions for industrial applications. A unique range of products and services creates the perfect basis for controlling processes securely and efficiently, protecting individuals from accidents and preventing damage to the environment.

We have extensive experience in a wide range of industries and understand their processes and requirements. With intelligent sensors, we can deliver exactly what our customers need. In application centers in Europe, Asia and North America, system solutions are tested and optimized in accordance with customer specifications. All this makes us a reliable supplier and development partner.

Comprehensive services complete our offering: SICK LifeTime Services provide support throughout the machine life cycle and ensure safety and productivity.

For us, that is “Sensor Intelligence.”

WORLDWIDE PRESENCE:

Contacts and other locations –www.sick.com