



# IMC12-08NPPVC0SB00

IMC

INDUCTIVE PROXIMITY SENSORS

**SICK**  
Sensor Intelligence.



Illustration may differ



### Ordering information

Type	Part no.
IMC12-08NPPVC0SB00	1093141

**Included in delivery:** BEF-MU-M12N (1)

Other models and accessories → [www.sick.com/IMC](http://www.sick.com/IMC)

### Detailed technical data

#### Features

<b>Housing</b>	Cylindrical thread design
<b>Thread size</b>	M12 x 1
<b>Diameter</b>	Ø 12 mm
<b>Sensing range <math>S_n</math></b>	0 mm ... 8 mm <sup>1)</sup>
<b>Safe sensing range <math>S_a</math></b>	6.48 mm
<b>Number of switching points</b>	Up to 4 adjustable switching points or windows
<b>Switching modes</b>	Single point, Window mode, Two point mode, Visual adjustment indicator
<b>Switching frequency Qint.1 / Qint.2 on Pin2</b>	1,000 Hz
<b>Installation type</b>	Non-flush
<b>Connection type</b>	Male connector M12, 4-pin <sup>2)</sup>
<b>Switching output</b>	PNP
<b>Output Q/C</b>	Switching output or IO-Link mode
<b>Output MFC</b>	Switching output or input
<b>Output function</b>	NC / NO
<b>Output characteristic</b>	Programmable
<b>Electrical wiring</b>	DC 4-wire
<b>Enclosure rating</b>	IP68 <sup>3)</sup> IP69K <sup>4)</sup>
<b>Special features</b>	Smart Task, Resistant against coolant lubricants, IO-Link
<b>Special applications</b>	Zones with coolants and lubricants, Difficult application conditions
<b>Special characteristic</b>	Resolution 16 digits

<sup>1)</sup> Adjustable.

<sup>2)</sup> With gold plated contact pins.

<sup>3)</sup> According to EN 60529.

<sup>4)</sup> According to ISO 20653:2013-03.

<b>Pin 2 configuration</b>	External input, Teach-in, switching signal
<b>Items supplied</b>	Mounting nut, V2A stainless steel, with locking teeth (2x)

- 1) Adjustable.  
 2) With gold plated contact pins.  
 3) According to EN 60529.  
 4) According to ISO 20653:2013-03.

## Mechanics/electronics

<b>Supply voltage</b>	10 V DC ... 30 V DC <sup>1)</sup>
<b>Ripple</b>	≤ 10 %
<b>Voltage drop</b>	≤ 2 V <sup>2)</sup>
<b>Hysteresis</b>	Programmable <sup>3)</sup>
<b>Reproducibility</b>	≤ 5 % <sup>4) 5)</sup>
<b>Temperature drift (of S<sub>r</sub>)</b>	± 10 %
<b>EMC</b>	According to EN 60947-5-2
<b>Continuous current I<sub>a</sub></b>	≤ 200 mA <sup>6)</sup>
<b>Short-circuit protection</b>	✓
<b>Reverse polarity protection</b>	✓
<b>Power-up pulse protection</b>	✓
<b>Shock and vibration resistance</b>	100 g / 2 ms / 500 cycles; 150 g / 1 Mio cycles; 10 Hz ... 55 Hz / 1 mm; 55 Hz ... 500 Hz / 60 g
<b>Ambient operating temperature</b>	-40 °C ... +75 °C
<b>Housing material</b>	Stainless steel V2A, DIN 1.4305 / AISI 303
<b>Sensing face material</b>	Plastic, LCP
<b>Housing length</b>	65 mm
<b>Thread length</b>	43 mm
<b>Tightening torque, max.</b>	Typ. 32 Nm <sup>7)</sup>
<b>UL File No.</b>	E181493
<b>Teach-in accuracy</b>	+/- 3% of S <sub>r</sub>
<b>Resolution, typical (range)</b>	20 μm (0 mm ... 4 mm) 50 μm (4 mm ... 6 mm) 100 μm (6 mm ... 8 mm)
<b>Resolution, maximum (area)</b>	40 μm (0 mm ... 4 mm) 100 μm (4 mm ... 6 mm) 200 μm (6 mm ... 8 mm)

- 1) IO-Link mode: 18 VDC ... 30 VDC.  
 2) At I<sub>a</sub> max.  
 3) To comply with EN 60947-5-2, a hysteresis of approx. 10% must be set.  
 4) U<sub>b</sub> and T<sub>a</sub> constant.  
 5) Of S<sub>r</sub>.  
 6) 200 mA total for both switching outputs.  
 7) Valid if toothed side of nut is used.

## Communication interface

<b>Communication interface</b>	IO-Link V1.1
<b>Communication Interface detail</b>	COM2 (38,4 kBaud)

<b>Cycle time</b>	5 ms
<b>Process data length</b>	32 Bit
<b>Process data structure</b>	Bit 0 = switching signal Q <sub>L1</sub> Bit 1 = switching signal Q <sub>L2</sub> Bit 2 = switching signal Q <sub>Int3</sub> Bit 3 = switching signal Q <sub>Int4</sub> Bit 16 ... 31 = distance value
<b>Factory setting</b>	Switching Point 1: reference value 1 Output: normally open Pin 2 configuration: input

### Reference values

<b>Note</b>	Reference value in Digits for switching point in mm stored in the sensor
<b>Reference value 1</b>	8 mm
<b>Reference value 2</b>	6 mm
<b>Reference value 3</b>	4 mm
<b>Reference value 4</b>	2 mm

### Reduction factors

<b>Stainless steel (V2A, 304)</b>	Approx. 0.7
<b>Aluminum (Al)</b>	Approx. 0.4
<b>Copper (Cu)</b>	Approx. 0.4
<b>Brass (Br)</b>	Approx. 0.4

### Installation note

<b>Remark</b>	Associated graphic see "Installation"
<b>A</b>	12 mm
<b>B</b>	24 mm
<b>C</b>	12 mm
<b>D</b>	24 mm
<b>E</b>	16 mm
<b>F</b>	64 mm

### Smart Task

<b>Smart Task name</b>	Base logics
<b>Logic function</b>	AND OR XOR Hysteresis
<b>Timer function</b>	On delay Off delay ON and OFF delay Impulse (one shot)
<b>Inverter</b>	Adjustable
<b>Switching frequency</b>	SIO Direct: 1000 Hz <sup>1)</sup> SIO Logic: 1000 Hz <sup>2)</sup>

<sup>1)</sup> SIO Direct: sensor operation in standard I/O mode without IO-Link communication and without using internal sensor logic or time parameters (set to "direct"/"deactivated").

<sup>2)</sup> SIO Logic: Sensor operation in standard I/O mode without IO-Link communication. Sensor-internal logic or timing parameters plus Automation Functions used.

<sup>3)</sup> IOL: Sensor operation with full IO-Link communication and usage of logic, timing and Automation Function parameters.

<b>Switching signal</b>		IOL: 1000 Hz <sup>3)</sup>
	Switching signal Q <sub>L1</sub>	Switching output
	Switching signal Q <sub>L2</sub>	Switching output

1) SIO Direct: sensor operation in standard I/O mode without IO-Link communication and without using internal sensor logic or time parameters (set to "direct"/"deactivated").

2) SIO Logic: Sensor operation in standard I/O mode without IO-Link communication. Sensor-internal logic or timing parameters plus Automation Functions used.

3) IOL: Sensor operation with full IO-Link communication and usage of logic, timing and Automation Function parameters.

### Classifications

<b>eCl@ss 5.0</b>	27270101
<b>eCl@ss 5.1.4</b>	27270101
<b>eCl@ss 6.0</b>	27270101
<b>eCl@ss 6.2</b>	27270101
<b>eCl@ss 7.0</b>	27270101
<b>eCl@ss 8.0</b>	27270101
<b>eCl@ss 8.1</b>	27270101
<b>eCl@ss 9.0</b>	27270101
<b>eCl@ss 10.0</b>	27270101
<b>eCl@ss 11.0</b>	27270101
<b>eCl@ss 12.0</b>	27274001
<b>ETIM 5.0</b>	EC002714
<b>ETIM 6.0</b>	EC002714
<b>ETIM 7.0</b>	EC002714
<b>ETIM 8.0</b>	EC002714
<b>UNSPSC 16.0901</b>	39122230

### Installation note

Non-flush installation

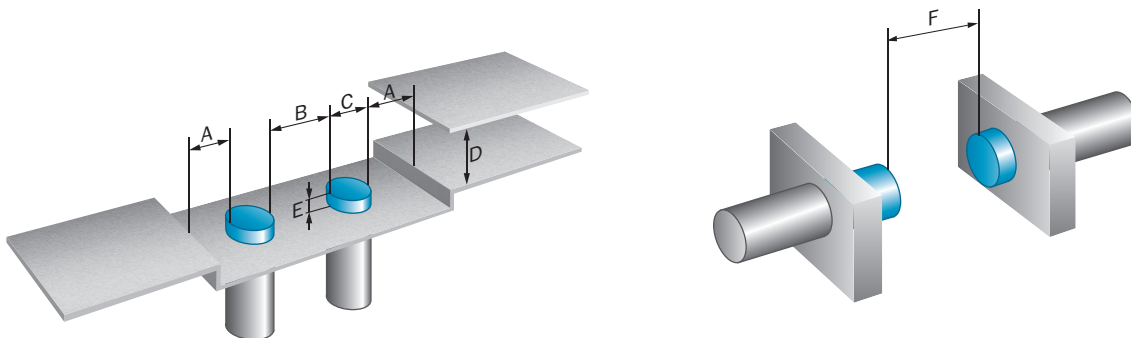

### Connection diagram

Cd-526

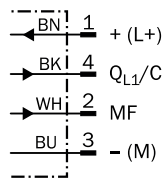

Q<sub>L1</sub>/C = Switching output,  
 IO-Link communication  
 MF = Multifunction

### Characteristic curve

Response diagram

Distance in mm (inch)

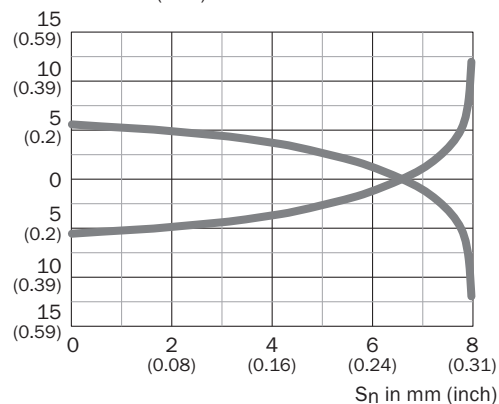





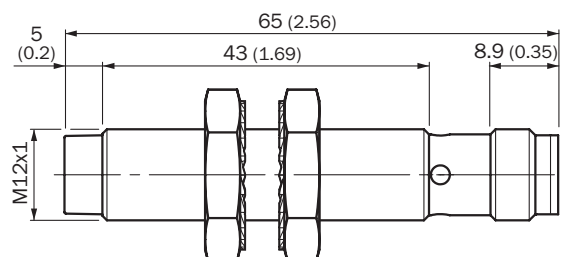



### Dimensional drawing (Dimensions in mm (inch))

IMC12 Standard, connector M12, non-flush



## Recommended accessories

Other models and accessories → [www.sick.com/IMC](http://www.sick.com/IMC)

	Brief description	Type	Part no.
<b>Connection modules</b>			
	IO-Link V1.1 Class A port, USB2.0 port, optional external power supply 24V / 1A	IOLA2US-01101 (SiLink2 Master)	1061790
	EtherCAT IO-Link Master, IO-Link V1.1, Port Class A, power supply via 7/8" cable 24 V / 8 A, fieldbus connection via M12 cable	IOLG2EC-03208R01 (IO-Link Master)	6053254
	EtherNet/IP IO-Link Master, IO-Link V1.1, Port Class A, power supply via 7/8" cable 24 V / 8 A, fieldbus connection via M12-cable	IOLG2EI-03208R01 (IO-Link Master)	6053255
	PROFINET IO-Link Master, IO-Link V1.1, Port Class A, power supply via 7/8" cable 24 V / 8 A, fieldbus connection via M12 cable	IOLG2PN-03208R01 (IO-Link Master)	6053253
<b>Universal bar clamp systems</b>			
	Plate N05N for universal clamp bracket, M12, Stainless steel 1.4571 (sheet), Stainless steel 1.4408 (clamp), Universal clamp (5322627), mounting hardware	BEF-KHS-N05N	2051621
	Plate N11N for universal clamp bracket, Stainless steel 1.4571 (sheet), Stainless steel 1.4408 (clamp), Universal clamp BEF-KHS-KH3 (5322626), mounting hardware	BEF-KHS-N11N	2071081
<b>Mounting brackets and plates</b>			
	Mounting plate for M12 sensors, stainless steel, without mounting hardware	BEF-WG-M12N	5320950
	Mounting bracket for M12 housing, stainless steel, without mounting hardware	BEF-WN-M12N	5320949
<b>Plug connectors and cables</b>			
	Head A: female connector, M12, 4-pin, straight Head B: Flying leads Cable: Sensor/actuator cable, PP, unshielded, 2 m This product is generally resistant to chemical cleaning agents (see ECOLAB) and other chemical compounds such as H2O2 and CH2O2. Before permanent installation is carried out, the material's resistance to the cleaning agent being used must be checked., Resistant against lactic acid & hydrogen peroxide (H2O2)	DOL-1204-G02MRN	6058291
	Head A: female connector, M12, 4-pin, straight Head B: Flying leads Cable: Sensor/actuator cable, PP, unshielded, 5 m This product is generally resistant to chemical cleaning agents (see ECOLAB) and other chemical compounds such as H2O2 and CH2O2. Before permanent installation is carried out, the material's resistance to the cleaning agent being used must be checked., Resistant against lactic acid & hydrogen peroxide (H2O2)	DOL-1204-G05MRN	6058476
	Head A: female connector, M12, 4-pin, angled Head B: Flying leads Cable: Sensor/actuator cable, PP, unshielded, 2 m This product is generally resistant to chemical cleaning agents (see ECOLAB) and other chemical compounds such as H2O2 and CH2O2. Before permanent installation is carried out, the material's resistance to the cleaning agent being used must be checked., Resistant against lactic acid & hydrogen peroxide (H2O2), only suitable for PNP sensors	DOL-1204-L02MRN	6058482

	Brief description	Type	Part no.
	<p>Head A: female connector, M12, 4-pin, angled                      Head B: Flying leads                      Cable: Sensor/actuator cable, PP, unshielded, 5 m                      This product is generally resistant to chemical cleaning agents (see ECOLAB) and other chemical compounds such as H2O2 and CH2O2. Before permanent installation is carried out, the material's resistance to the cleaning agent being used must be checked., Resistant against lactic acid &amp; hydrogen peroxide (H2O2), only suitable for PNP sensors</p>	DOL-1204-L05MRN	6058483
	<p>Head A: female connector, M12, 4-pin, angled                      Head B: Flying leads                      Cable: Sensor/actuator cable, PP, unshielded, 2 m                      This product is generally resistant to chemical cleaning agents (see ECOLAB) and other chemical compounds such as H2O2 and CH2O2. Before permanent installation is carried out, the material's resistance to the cleaning agent being used must be checked., Resistant against lactic acid &amp; hydrogen peroxide (H2O2)</p>	DOL-1204-W02MRN	6058474
	<p>Head A: female connector, M12, 4-pin, angled                      Head B: Flying leads                      Cable: Sensor/actuator cable, PP, unshielded, 5 m                      This product is generally resistant to chemical cleaning agents (see ECOLAB) and other chemical compounds such as H2O2 and CH2O2. Before permanent installation is carried out, the material's resistance to the cleaning agent being used must be checked., Resistant against lactic acid &amp; hydrogen peroxide (H2O2)</p>	DOL-1204-W05MRN	6058477
	<p>Head A: female connector, M12, 4-pin, angled                      Head B: male connector, M12, 4-pin, straight                      Cable: Sensor/actuator cable, PP, unshielded, 2 m                      This product is generally resistant to chemical cleaning agents (see ECOLAB) and other chemical compounds such as H2O2 and CH2O2. Before permanent installation is carried out, the material's resistance to the cleaning agent being used must be checked., Resistant against lactic acid &amp; hydrogen peroxide (H2O2)</p>	DSL-1204-B02MRN	6058502
	<p>Head A: female connector, M12, 4-pin, angled                      Head B: male connector, M12, 4-pin, straight                      Cable: Sensor/actuator cable, PP, unshielded, 5 m                      This product is generally resistant to chemical cleaning agents (see ECOLAB) and other chemical compounds such as H2O2 and CH2O2. Before permanent installation is carried out, the material's resistance to the cleaning agent being used must be checked., Resistant against lactic acid &amp; hydrogen peroxide (H2O2)</p>	DSL-1204-B05MRN	6058503
	<p>Head A: female connector, M12, 4-pin, straight                      Head B: male connector, M12, 4-pin, straight                      Cable: Sensor/actuator cable, PP, unshielded, 2 m                      This product is generally resistant to chemical cleaning agents (see ECOLAB) and other chemical compounds such as H2O2 and CH2O2. Before permanent installation is carried out, the material's resistance to the cleaning agent being used must be checked., Resistant against lactic acid &amp; hydrogen peroxide (H2O2)</p>	DSL-1204-G02MRN	6058499
	<p>Head A: female connector, M12, 4-pin, straight                      Head B: male connector, M12, 4-pin, straight                      Cable: Sensor/actuator cable, PP, unshielded, 5 m                      This product is generally resistant to chemical cleaning agents (see ECOLAB) and other chemical compounds such as H2O2 and CH2O2. Before permanent installation is carried out, the material's resistance to the cleaning agent being used must be checked., Resistant against lactic acid &amp; hydrogen peroxide (H2O2)</p>	DSL-1204-G05MRN	6058500

## Recommended services

Additional services → [www.sick.com/IMC](https://www.sick.com/IMC)

	Type	Part no.
Function Block Factory		
<ul style="list-style-type: none"><li><b>Description:</b> The Function Block Factory supports common programmable logic controllers (PLCs) from various manufacturers, such as Siemens, Beckhoff, Rockwell Automation and B&amp;R. More information on the FBF can be found <a _blank"="" href="https://fbf.cloud.sick.com target=">here</a>.</li></ul>	Function Block Factory	On request

## SICK AT A GLANCE

SICK is one of the leading manufacturers of intelligent sensors and sensor solutions for industrial applications. A unique range of products and services creates the perfect basis for controlling processes securely and efficiently, protecting individuals from accidents and preventing damage to the environment.

We have extensive experience in a wide range of industries and understand their processes and requirements. With intelligent sensors, we can deliver exactly what our customers need. In application centers in Europe, Asia and North America, system solutions are tested and optimized in accordance with customer specifications. All this makes us a reliable supplier and development partner.

Comprehensive services complete our offering: SICK LifeTime Services provide support throughout the machine life cycle and ensure safety and productivity.

For us, that is “Sensor Intelligence.”

## WORLDWIDE PRESENCE:

Contacts and other locations –[www.sick.com](http://www.sick.com)