



# CLV620-1120

CLV62x

**FIXED MOUNT BARCODE SCANNERS**

**SICK**  
Sensor Intelligence.



### Ordering information

Type	Part no.
CLV620-1120	1041549

Other models and accessories → [www.sick.com/CLV62x](http://www.sick.com/CLV62x)



### Detailed technical data

#### Features

<b>Version</b>	Mid Range
<b>Connection type</b>	Ethernet
<b>Reading field</b>	Front
<b>Sensor type</b>	Raster scanner
<b>Optical focus</b>	Fixed focus
<b>Light source</b>	Light spot, laser, Visible, Red, 655 nm
<b>Laser class</b>	2 (IEC 60825-1:2014, EN 60825-1:2014)
<b>Aperture angle</b>	≤ 50°
<b>Reading distance</b>	60 mm ... 365 mm <sup>1)</sup>
<b>Scanning frequency</b>	400 Hz ... 1,200 Hz
<b>Code resolution</b>	0.2 mm ... 1 mm
<b>Raster height, number of lines, at distance</b>	15 mm, 8, 200 mm

<sup>1)</sup> For details see reading field diagram.

#### Mechanics/electronics

<b>Connection type</b>	2 x M12 cylindrical connectors (12-pin male connector, 4-pin female connector) on swivel connector
<b>Supply voltage</b>	10 V DC ... 30 V DC
<b>Power consumption</b>	4.5 W
<b>Housing</b>	Aluminum die cast
<b>Housing color</b>	Light blue (RAL 5012)
<b>Window material</b>	Glass
<b>Enclosure rating</b>	IP65 (DIN 40 050)

<sup>1)</sup> Swivel connector is 15 mm longer.

<sup>2)</sup> At 25 °C.

<b>Protection class</b>	III (VDE 0106/IEC 1010-1)
<b>Weight</b>	205 g, without connecting cable
<b>Dimensions (L x W x H)</b>	61 mm x 66 mm x 38 mm <sup>1)</sup>
<b>MTBF</b>	100,000 h
<b>MTTF</b>	40,000 h (Laser diode) <sup>2)</sup>

<sup>1)</sup> Swivel connector is 15 mm longer.

<sup>2)</sup> At 25 °C.

## Performance

<b>Readable code structures</b>	1D codes
<b>Bar code types</b>	All current code types, Code 39, Code 128, Code 93, Codabar, GS1-128 / EAN 128, UPC / GTIN / EAN, Interleaved 2 of 5, Pharmacode, GS1 DataBar, Telepen, MSI/Plessey
<b>Code printing process</b>	Label (printed codes)
<b>Print ratio</b>	2:1 ... 3:1
<b>No. of codes per scan</b>	1 ... 20 (Standard decoder) 1 ... 6 (SMART620)
<b>No. of codes per reading interval</b>	1 ... 50 (auto-discriminating)
<b>No. of characters per reading interval</b>	1,500 500 (for multiplexer function in CAN operation)
<b>No. of multiple readings</b>	1 ... 99

## Interfaces

<b>Ethernet</b>	✓, TCP/IP
Function	Host, AUX
Data transmission rate	10/100 MBit/s
<b>PROFINET</b>	✓
Function	PROFINET Single Port, PROFINET Dual Port (optional via external connection module CDF600-2)
Data transmission rate	10/100 MBit/s
<b>EtherNet/IP™</b>	✓
Data transmission rate	10/100 MBit/s
<b>EtherCAT</b>	✓
Type of fieldbus integration	Optional over external fieldbus module CDF600
<b>Serial</b>	✓, RS-232, RS-422, RS-485
Function	Host, AUX
Data transmission rate	2,400 Baud ... 115.2 kBaud, AUX: 57.6 kBaud (RS-232)
<b>CAN</b>	✓
Function	SICK CAN sensor network CSN (CAN controller/CAN device, multiplexer/server)
Data transmission rate	20 kbit/s ... 1 Mbit/s
<b>CANopen</b>	✓
Data transmission rate	20 kbit/s ... 1 Mbit/s
<b>PROFIBUS DP</b>	✓
Type of fieldbus integration	Optional over external fieldbus module CDF600-2
<b>Digital inputs</b>	3 ("Sensor 1", 2 inputs via optional parameter storage CMC600 in CDB620/CDM420)
<b>Digital outputs</b>	2 (Via optional CMC600 parameter memory in CDB620/CDM420)

<b>Reading pulse</b>	Digital inputs, non-powered, serial interface, auto pulse, CAN
<b>Optical indicators</b>	6 LEDs (Ready) , Result , laser , Data , CAN , LNK TX
<b>Acoustic indicators</b>	Beeper/buzzer (can be switched off, can be allocated as a result indication function)
<b>Configuration software</b>	SOPAS ET

Ambient data

<b>Electromagnetic compatibility (EMC)</b>	EN 61000-6-3 (2001-10) / EN 61000-6-2:2005
<b>Vibration resistance</b>	EN 60068-2-6 (1995)
<b>Shock resistance</b>	EN 60068-2-27 (1993)
<b>Ambient operating temperature</b>	0 °C ... +40 °C
<b>Storage temperature</b>	-20 °C ... +70 °C
<b>Permissible relative humidity</b>	90 %, Non-condensing
<b>Ambient light immunity</b>	2,000 lx, on barcode
<b>Bar code print contrast (PCS)</b>	≥ 60 %

Classifications

<b>eCl@ss 5.0</b>	27280102
<b>eCl@ss 5.1.4</b>	27280102
<b>eCl@ss 6.0</b>	27280102
<b>eCl@ss 6.2</b>	27280102
<b>eCl@ss 7.0</b>	27280102
<b>eCl@ss 8.0</b>	27280102
<b>eCl@ss 8.1</b>	27280102
<b>eCl@ss 9.0</b>	27280102
<b>eCl@ss 10.0</b>	27280102
<b>eCl@ss 11.0</b>	27280102
<b>eCl@ss 12.0</b>	27280102
<b>ETIM 5.0</b>	EC002550
<b>ETIM 6.0</b>	EC002550
<b>ETIM 7.0</b>	EC002550
<b>ETIM 8.0</b>	EC002550
<b>UNSPSC 16.0901</b>	43211701

Dimensional drawing (Dimensions in mm (inch))

CLV62x Ethernet, front

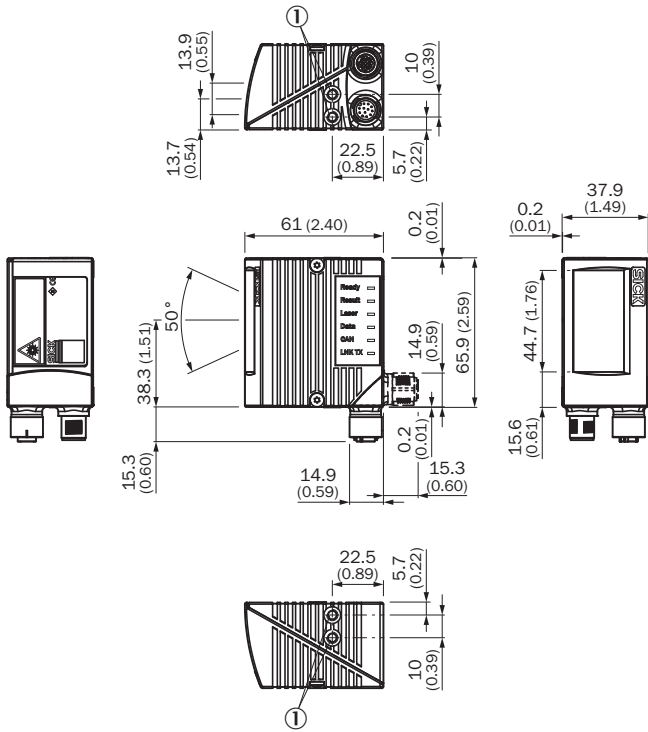

① M5

Reading field diagram

Reading field height in mm (inch)

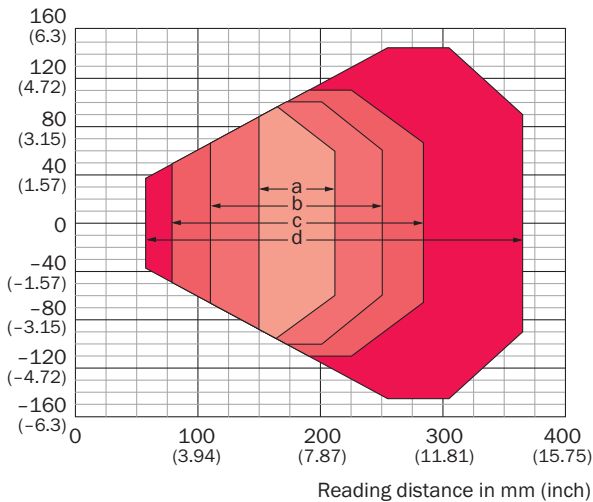







For devices with plastic reading window, the depth of field is reduced by approx. 10 %.

Resolution

- a: 0.2 mm (7.9 mil)
- b: 0.35 mm (13.8 mil)
- c: 0.50 mm (19.7 mil)
- d: 1.00 mm (39.4 mil)

### Recommended accessories

Other models and accessories → [www.sick.com/CLV62x](http://www.sick.com/CLV62x)

	Brief description	Type	Part no.
<b>Cloning module</b>			
	External parameter memory for integration in CDB620/CDB650/CDM42x	CMC600-101	1042259
<b>Mounting brackets and plates</b>			
	Bracket with adapter board	Mounting bracket	2042902
<b>Plug connectors and cables</b>			
	Head A: male connector, M12, 4-pin, straight, D-coded Head B: male connector, M12, 4-pin, straight, D-coded Cable: Ethernet, PROFINET, PUR, halogen-free, shielded, 2 m	YM2D24-020PN1M2D24	2106159
	Head A: male connector, M12, 4-pin, straight, D-coded Head B: male connector, RJ45, 4-pin, straight Cable: Ethernet, PROFINET, PUR, halogen-free, shielded, 2 m	YM2D24-020PN1MRJA4	2106182
	Head A: male connector, M12, 4-pin, straight, D-coded Head B: male connector, M12, 4-pin, straight, D-coded Cable: Ethernet, PROFINET, PUR, halogen-free, shielded, 3 m	YM2D24-030PN1M2D24	2113266
	Head A: male connector, M12, 4-pin, straight, D-coded Head B: male connector, M12, 4-pin, straight, D-coded Cable: Ethernet, PROFINET, PUR, halogen-free, shielded, 5 m	YM2D24-050PN1M2D24	2106160
	Head A: male connector, M12, 4-pin, straight, D-coded Head B: male connector, M12, 4-pin, straight, D-coded Cable: Ethernet, PROFINET, PUR, halogen-free, shielded, 10 m	YM2D24-100PN1M2D24	2106161
<b>Modules</b>			
	<ul style="list-style-type: none"> <li>• <b>Sub product family:</b> CDB620</li> <li>• <b>Supported products:</b> CLV61x - CLV65x, Lector62x, RFH6xx, RFU62x</li> <li>• <b>Brief description:</b> Small connection module for one sensor, 4 cable glands, base for CMC600</li> </ul>	CDB620-001	1042256

### Recommended services

Additional services → [www.sick.com/CLV62x](http://www.sick.com/CLV62x)

	Type	Part no.
<b>Performance check</b>		
<ul style="list-style-type: none"> <li>• <b>Product area:</b> Fixed mount barcode scanners</li> <li>• <b>Range of services:</b> Inspection of defined functions, e.g., reading performance</li> <li>• <b>Travel expenses:</b> The prices do not include travel costs such as hotel, flight, travel time and expenses.</li> <li>• <b>Duration:</b> Additional work will be invoiced separately</li> </ul>	Performance check CLV4xx/CLV6xx	1682028

	Type	Part no.
Commissioning		
<ul style="list-style-type: none"> <li>• <b>Product area:</b> Fixed mount barcode scanners</li> <li>• <b>Range of services:</b> Inspection of connection, fine adjustment, optimization of parameters of SICK product as well as tests, Setup of previously defined functions of reading configuration, code configuration, data processing and network, interfaces or inputs and outputs</li> <li>• <b>Travel expenses:</b> The prices do not include travel costs such as hotel, flight, travel time and expenses.</li> <li>• <b>Duration:</b> Additional work will be invoiced separately</li> </ul>	Commissioning CLV61x ... CLV64x	1681925
Extended warranty		
<ul style="list-style-type: none"> <li>• <b>Product area:</b> Identification solutions, machine vision, Distance sensors, Detection and ranging solutions</li> <li>• <b>Range of services:</b> The services correspond to the scope of the statutory manufacturer warranty (SICK general terms of delivery).</li> <li>• <b>Duration:</b> Five-year warranty from delivery date.</li> </ul>	Extended warranty for a total of five years from delivery date	1680671

## SICK AT A GLANCE

SICK is one of the leading manufacturers of intelligent sensors and sensor solutions for industrial applications. A unique range of products and services creates the perfect basis for controlling processes securely and efficiently, protecting individuals from accidents and preventing damage to the environment.

We have extensive experience in a wide range of industries and understand their processes and requirements. With intelligent sensors, we can deliver exactly what our customers need. In application centers in Europe, Asia and North America, system solutions are tested and optimized in accordance with customer specifications. All this makes us a reliable supplier and development partner.

Comprehensive services complete our offering: SICK LifeTime Services provide support throughout the machine life cycle and ensure safety and productivity.

For us, that is “Sensor Intelligence.”

## WORLDWIDE PRESENCE:

Contacts and other locations –[www.sick.com](http://www.sick.com)