



# WTT280L-2P2536

PowerProx

MULTITASK PHOTOELECTRIC SENSORS

**SICK**  
Sensor Intelligence.



Illustration may differ



### Ordering information

Type	Part no.
WTT280L-2P2536	6048062

**Included in delivery:** BEF-W280 (1)

Other models and accessories → [www.sick.com/PowerProx](http://www.sick.com/PowerProx)

### Detailed technical data

#### Features

<b>Device type</b>	Photoelectric sensors
<b>Sensor/ detection principle</b>	Photoelectric proximity sensor, Background suppression
<b>Dimensions (W x H x D)</b>	23.5 mm x 76 mm x 55.8 mm
<b>Housing design (light emission)</b>	Rectangular
<b>Sensing range max.</b>	200 mm ... 4,000 mm <sup>1)</sup> 200 mm ... 3,000 mm <sup>2)</sup>
<b>Sensing range</b>	200 mm ... 4,000 mm <sup>1) 3)</sup> 200 mm ... 3,000 mm <sup>2) 3)</sup>
<b>Type of light</b>	Visible red light
<b>Light source</b>	Laser <sup>4)</sup>
<b>Light spot size (distance)</b>	Ø 12 mm (3 m)
<b>Laser class</b>	1 (EN 60825-1:2014, IEC 60825-1:2014)
<b>Adjustment</b>	Potentiometer (2 x)
<b>Special applications</b>	Detecting small objects

<sup>1)</sup> Object with 90 % reflectance (referred to standard white, DIN 5033).

<sup>2)</sup> Objects to be sensed with 6 % reflectivity (based on black).

<sup>3)</sup> Einstellbar.

<sup>4)</sup> Average service life: 100,000 h at T<sub>J</sub> = +25 °C.

## Mechanics/electronics

<b>Supply voltage</b>	10 V DC ... 30 V DC <sup>1)</sup>
<b>Ripple</b>	< 3 V <sub>pp</sub>
<b>Current consumption</b>	70 mA <sup>2)</sup>
<b>Switching output</b>	PNP
<b>Number of switching outputs</b>	2 (Q <sub>1</sub> , Q <sub>2</sub> ) <sup>3)</sup>
<b>Switching mode</b>	Light/dark switching
<b>Switching mode selector</b>	Selectable via light/dark rotary switch
<b>Output current I<sub>max</sub></b>	≤ 100 mA
<b>Response time</b>	≤ 0.5 ms <sup>4)</sup>
<b>Switching frequency</b>	1,000 Hz <sup>5)</sup>
<b>Analog output</b>	-
<b>Input</b>	Sender off
<b>Connection type</b>	Male connector M12, 5-pin
<b>Circuit protection</b>	A <sup>6)</sup> B <sup>7)</sup> C <sup>8)</sup> D <sup>9)</sup>
<b>Protection class</b>	III
<b>Weight</b>	120 g
<b>Housing material</b>	Plastic, ABS
<b>Optics material</b>	Plastic, PMMA
<b>Enclosure rating</b>	IP67
<b>Items supplied</b>	Mounting bracket BEF-W280
<b>Electromagnetic compatibility (EMC)</b>	EN 60947-5-2
<b>Ambient operating temperature</b>	-10 °C ... +50 °C
<b>Ambient temperature, storage</b>	-40 °C ... +70 °C
<b>UL File No.</b>	NRKH2.E300503 & NRKH8.E300503

<sup>1)</sup> Limit values. Operated in short-circuit protected network: max. 8 A.

<sup>2)</sup> Without load.

<sup>3)</sup> Q<sub>1</sub>, Q<sub>2</sub> = 2 switching thresholds, light/dark switching selectable via light/dark selector.

<sup>4)</sup> Signal transit time with resistive load.

<sup>5)</sup> With light/dark ratio 1:1.

<sup>6)</sup> A = V<sub>S</sub> connections reverse-polarity protected.

<sup>7)</sup> B = output reverse-polarity protected.

<sup>8)</sup> C = interference suppression.

<sup>9)</sup> D = outputs overcurrent and short-circuit protected.

## Safety-related parameters

<b>MTTF<sub>D</sub></b>	193 years
<b>DC<sub>avg</sub></b>	0 %

## Classifications

<b>ECl@ss 5.0</b>	27270904
<b>ECl@ss 5.1.4</b>	27270904

<b>ECl@ss 6.0</b>	27270904
<b>ECl@ss 6.2</b>	27270904
<b>ECl@ss 7.0</b>	27270904
<b>ECl@ss 8.0</b>	27270904
<b>ECl@ss 8.1</b>	27270904
<b>ECl@ss 9.0</b>	27270904
<b>ECl@ss 10.0</b>	27270904
<b>ECl@ss 11.0</b>	27270904
<b>ETIM 5.0</b>	EC002719
<b>ETIM 6.0</b>	EC002719
<b>ETIM 7.0</b>	EC002719
<b>ETIM 8.0</b>	EC002719
<b>UNSPSC 16.0901</b>	39121528

Connection/pin assignment

<b>Connection type</b>	Male connector M12, 5-pin
------------------------	---------------------------

Connection type

WTT280L-2x25xx WLT280L-2x25xx

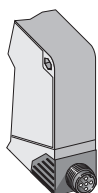

Connection diagram

Cd-211

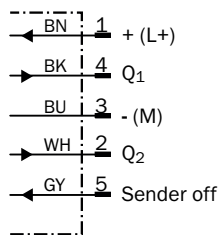

**Characteristic curve**

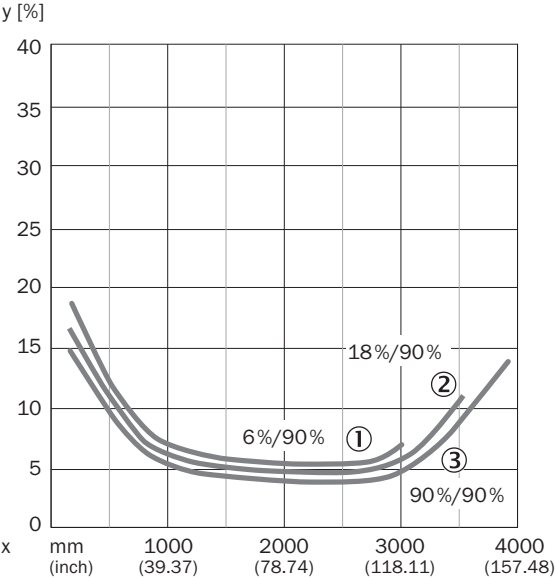

- ① Sensing range on black, 6% remission
- ② Sensing range on gray, 18 % remission
- ③ Sensing range on white, 90% remission

**Sensing range diagram**

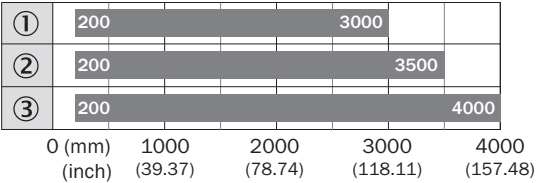

- Sensing range max.
- ① Sensing range on black, 6% remission
- ② Sensing range on gray, 18 % remission
- ③ Sensing range on white, 90% remission

## Adjustments

WxT280L-2xxxx6

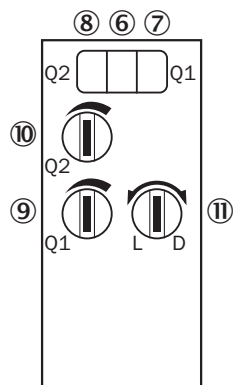

- ⑥ LED indicator green: Stability indicator
- ⑦ Status indicator LED, yellow: Status of received light beam (switching output 1)
- ⑧ Status indicator LED, yellow: Status of received light beam (switching output 2)
- ⑨ Sensing range adjustment: potentiometer for switching output 1
- ⑩ Sensing range adjustment: potentiometer for switching output 2
- ⑪ Light/dark selector

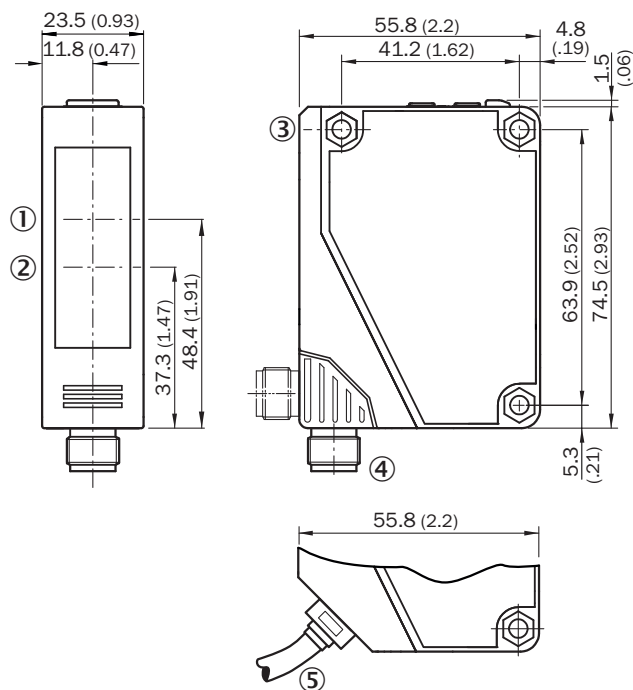

## Dimensional drawing (Dimensions in mm (inch))



- ① Center of optical axis, receiver
- ② Center of optical axis, sender
- ③ Mounting hole,  $\varnothing$  4.3 mm
- ④ M12 plug connector, 5-pin, can be rotated through 90°
- ⑤ Cable, 2 m, 5-wire,  $\varnothing$  3.8 mm

### Recommended accessories

Other models and accessories → [www.sick.com/PowerProx](http://www.sick.com/PowerProx)

	Brief description	Type	Part no.
<b>Mounting brackets and plates</b>			
	Mounting bracket, Stainless steel V2A (1.4301), 2 screws, 2 nuts, 2 circlips, 2 washers for mounting the sensor	BEF-W280	5313885
<b>Plug connectors and cables</b>			
	Head A: female connector, M12, 5-pin, straight, A-coded Head B: Flying leads Cable: Sensor/actuator cable, PVC, unshielded, 5 m	YF2A15-050VB5XLEAX	2096240
	Head A: male connector, M12, 5-pin, straight Cable: unshielded For field bus technology	STE-1205-G	6022083

## SICK AT A GLANCE

SICK is one of the leading manufacturers of intelligent sensors and sensor solutions for industrial applications. A unique range of products and services creates the perfect basis for controlling processes securely and efficiently, protecting individuals from accidents and preventing damage to the environment.

We have extensive experience in a wide range of industries and understand their processes and requirements. With intelligent sensors, we can deliver exactly what our customers need. In application centers in Europe, Asia and North America, system solutions are tested and optimized in accordance with customer specifications. All this makes us a reliable supplier and development partner.

Comprehensive services complete our offering: SICK LifeTime Services provide support throughout the machine life cycle and ensure safety and productivity.

For us, that is “Sensor Intelligence.”

## WORLDWIDE PRESENCE:

Contacts and other locations –[www.sick.com](http://www.sick.com)