



RT-M2117

ZoneControl

MULTITASK PHOTOELECTRIC SENSORS

SICK
Sensor Intelligence.



Illustration may differ



Ordering information

Type	Part no.
RT-M2117	1063197

Other models and accessories → www.sick.com/ZoneControl

Detailed technical data

Features

Device type	Photoelectric sensors
Sensor/ detection principle	Photoelectric proximity sensor, Background suppression
Dimensions (W x H x D)	20.6 mm x 99.2 mm x 48.9 mm
Sensing range max.	60 mm ... 900 mm
Sensing range	60 mm ... 900 mm
Focus	7°
Type of light	Infrared light
Light source	LED ¹⁾
Light spot size (distance)	Ø 20 mm (500 mm)
Angle of dispersion	7°
Adjustment	Potentiometer, 9 turns
Special applications	ZoneControl

¹⁾ Average service life: 100,000 h at T_J = +25 °C.

Mechanics/electronics

Supply voltage	21.6 V DC ... 250 V DC, 96 ... 250 V AC @ 60 Hz, 111 ... 250 V AC @ 50 Hz ^{1) 2) 3)}
-----------------------	---

¹⁾ Limit values.

²⁾ UL requires the Rx-Mxxxx sensor to be installed in a circuit protected by a listed fuse, a listed (DHWZ/7) molded-case circuit breaker, or a supplementary R/C protection device (QVNU2/8) with min. 250 V, max. 2 A rating or equivalent.

³⁾ The output load and sensor must use the same power source.

⁴⁾ May not exceed or fall below U_v tolerances.

⁵⁾ Without load and valve deenergized.

⁶⁾ Do not bend below 0 °C.

⁷⁾ A = V_S connections reverse-polarity protected.

⁸⁾ C = interference suppression.

⁹⁾ D = outputs overcurrent and short-circuit protected.

Ripple	< 5 V _{pp} ⁴⁾
Current consumption	10 mA ⁵⁾
Switching output	FET
Switching mode	Dark switching
Signal voltage NPN HIGH/LOW	Approx. VS / < 2.0 V
Output current I_{max.}	≤ 100 mA
Response time	2 ms
Switching frequency	250 Hz
Connection type	Cable, 4-wire, 2 m ⁶⁾
Circuit protection	A ⁷⁾ C ⁸⁾ D ⁹⁾
Protection class	II
Weight	175 g
Housing material	Plastic, ABS
Enclosure rating	IP67
Shock and vibration resistance	According to IEC 68
Ambient operating temperature	-40 °C ... +40 °C
Ambient temperature, storage	-40 °C ... +75 °C
UL File No.	NRKH.E189383 & NRKH7.E189383

1) Limit values.

2) UL requires the Rx-Mxxxx sensor to be installed in a circuit protected by a listed fuse, a listed (DHWZ/7) molded-case circuit breaker, or a supplementary R/C protection device (QVNU2/8) with min. 250 V, max. 2 A rating or equivalent.

3) The output load and sensor must use the same power source.

4) May not exceed or fall below U_v tolerances.

5) Without load and valve deenergized.

6) Do not bend below 0 °C.

7) A = V_S connections reverse-polarity protected.

8) C = interference suppression.

9) D = outputs overcurrent and short-circuit protected.

Safety-related parameters

MTTF_D	552 years
DC_{avg}	0 %

Classifications

ECl@ss 5.0	27270904
ECl@ss 5.1.4	27270904
ECl@ss 6.0	27270904
ECl@ss 6.2	27270904
ECl@ss 7.0	27270904
ECl@ss 8.0	27270904
ECl@ss 8.1	27270904
ECl@ss 9.0	27270904
ECl@ss 10.0	27270904

ECl@ss 11.0	27270904
ETIM 5.0	EC002719
ETIM 6.0	EC002719
ETIM 7.0	EC002719
ETIM 8.0	EC002719
UNSPSC 16.0901	39121528

Connection diagram

Cd-035

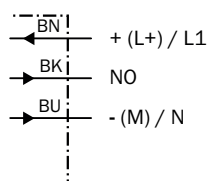

Characteristic curve

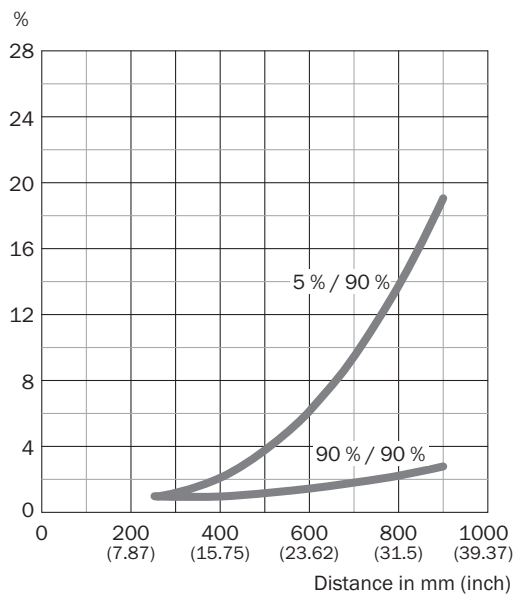

Light spot size

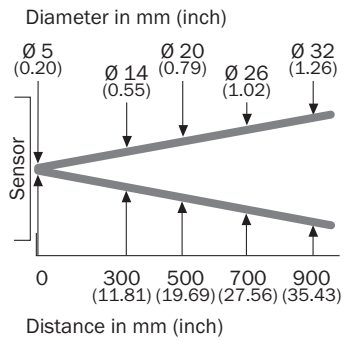

Dimensional drawing (Dimensions in mm (inch))

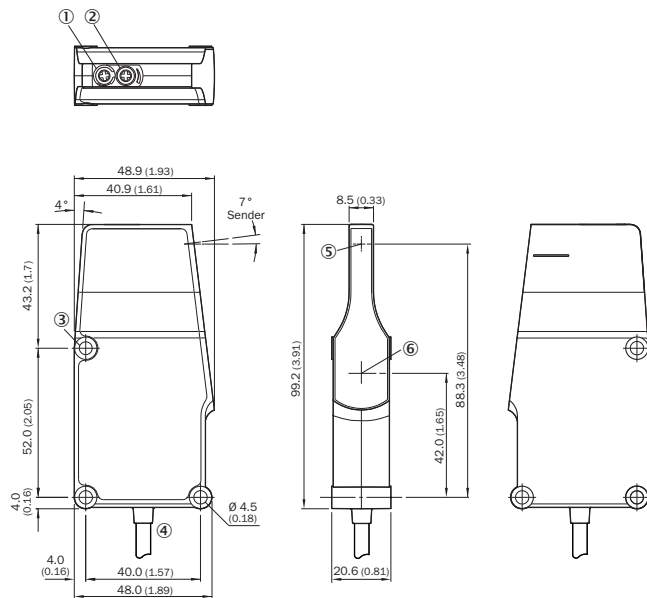

R cable



- ① LED
- ② Potentiometer
- ③ Fixing hole
- ④ Cable
- ⑤ Center of optical axis, sender
- ⑥ Center of optical axis, receiver

Recommended accessories

Other models and accessories → www.sick.com/ZoneControl

	Brief description	Type	Part no.
Mounting brackets and plates			
	Mounting bracket, steel, zinc coated, mounting hardware included	BEF-WK-WTR	2051786
		BEF-WN-RT/IRT	2074621
Plug connectors and cables			
	Head A: male connector, M12, 4-pin, straight Head B: - Cable: unshielded	STE-1204-G	6009932

SICK AT A GLANCE

SICK is one of the leading manufacturers of intelligent sensors and sensor solutions for industrial applications. A unique range of products and services creates the perfect basis for controlling processes securely and efficiently, protecting individuals from accidents and preventing damage to the environment.

We have extensive experience in a wide range of industries and understand their processes and requirements. With intelligent sensors, we can deliver exactly what our customers need. In application centers in Europe, Asia and North America, system solutions are tested and optimized in accordance with customer specifications. All this makes us a reliable supplier and development partner.

Comprehensive services complete our offering: SICK LifeTime Services provide support throughout the machine life cycle and ensure safety and productivity.

For us, that is “Sensor Intelligence.”

WORLDWIDE PRESENCE:

Contacts and other locations –www.sick.com