



# WTB4FT-1H161120A00

W4F

MINIATURE PHOTOELECTRIC SENSORS

**SICK**  
Sensor Intelligence.



Illustration may differ



## Ordering information

| Type               | Part no. |
|--------------------|----------|
| WTB4FT-1H161120A00 | 1113177  |

Other models and accessories → [www.sick.com/W4F](http://www.sick.com/W4F)

## Detailed technical data

### Features

|   |   |
|---|---|
| <b>Functional principle</b>   | Photoelectric proximity sensor  |
| <b>Functional principle detail</b>  | Background suppression, DoubleLine  |
| <b>Sensing range</b>  |   |
| Sensing range min.  | 7 mm  |
| Sensing range max.  | 120 mm  |
| Adjustable switching threshold for background suppression                                       | 15 mm ... 120 mm  |
| Reference object  | Object with 90% remission factor (complies with standard white according to DIN 5033) |
| Minimum distance between set sensing range and background (black 6% / white 90%)                | 1 mm, at a distance of 50 mm  |
| Recommended sensing range for the best performance  | 30 mm ... 80 mm   |
| <b>Emitted beam</b>   |   |
| Light source  | PinPoint LED  |
| Type of light   | Visible red light   |
| Shape of light spot   | Line-shaped, two parallel line-shaped light spots                                     |
| Light spot size (distance)  | 1.2 mm x 17 mm (50 mm)  |
| Maximum dispersion of the emitted beam around the standardized transmission axis (squint angle) | < +/- 1.5° (at Ta = +23 °C)   |

|  |  |  |
|--|--|--|
| <b>Key LED figures</b>                       |  |  |
| Normative reference                          | EN 62471:2008-09   IEC 62471:2006, modified  |  |
| LED risk group marking                       | Free group   |  |
| Wave length                                  | 635 nm   |  |
| Average service life                         | 100,000 h at T <sub>a</sub> = +25 °C   |  |
| <b>Smallest detectable object (MDO) typ.</b> |  | 1 mm (At 50 mm distance (object with 90% remission (complies with standard white according to DIN 5033)))                |
| <b>Adjustment</b>                            |  |  |
| Teach-Turn adjustment                        | BluePilot: For setting the sensing range   |  |
| IO-Link                                      | For configuring the sensor parameters and Smart Task functions                               |  |
| <b>Indication</b>                            |  |  |
| LED blue                                     | BluePilot: sensing range indicator   |  |
| LED green                                    | Operating indicator<br>Static on: power on<br>Flashing: IO-Link mode                         |  |
| LED yellow                                   | Status of received light beam<br>Static on: object present<br>Static off: object not present |  |
| <b>Special applications</b>                  |  | Detecting flat objects, Detecting objects wrapped in film, Detecting perforated objects, Detecting uneven, shiny objects |

#### Safety-related parameters

|                                     |  |
|-------------------------------------|--|
| <b>MTTF<sub>D</sub></b>             | 661 years                                    |
| <b>DC<sub>avg</sub></b>             | 0 %  |
| <b>T<sub>M</sub> (mission time)</b> | 20 years (EN ISO 13849)<br>Rate of use: 60 % |

#### Communication interface

|                             |  |
|-----------------------------|--|
| <b>IO-Link</b>              | ✓, IO-Link V1.1  |
| Data transmission rate      | COM2 (38,4 kBaud)  |
| Cycle time                  | 2.3 ms   |
| Process data length         | 16 Bit   |
| Process data structure      | Bit 0 = switching signal Q <sub>L1</sub><br>Bit 1 = switching signal Q <sub>L2</sub><br>Bit 2 ... 15 = Current receiver level (live) |
| VendorID                    | 26   |
| DeviceID HEX                | 0x80024D   |
| DeviceID DEC                | 8389197  |
| Compatible master port type | A  |
| SIO mode support            | Yes  |

#### Electrical data

|                                     |                                   |
|-------------------------------------|-----------------------------------|
| <b>Supply voltage U<sub>B</sub></b> | 10 V DC ... 30 V DC <sup>1)</sup> |
| <b>Ripple</b>                       | ≤ 5 V <sub>pp</sub>               |

<sup>1)</sup> Limit values.

<sup>2)</sup> Signal transit time with resistive load in switching mode.

<sup>3)</sup> With light/dark ratio 1:1.

|                                       |   |
|---------------------------------------|---|
| <b>Usage category</b>                 | DC-12 (According to EN 60947-5-2)<br>DC-13 (According to EN 60947-5-2)                          |
| <b>Current consumption</b>            | ≤ 25 mA, without load. At $U_B = 24\text{ V}$   |
| <b>Protection class</b>               | III   |
| <b>Digital output</b>                 |   |
| Number                                | 2 (Complementary)   |
| Type                                  | Push-pull: PNP/NPN  |
| Signal voltage PNP HIGH/LOW           | Approx. $U_B - 2.5\text{ V} / 0\text{ V}$   |
| Signal voltage NPN HIGH/LOW           | Approx. $U_B / < 2.5\text{ V}$  |
| Output current $I_{\max.}$            | ≤ 100 mA  |
| Circuit protection outputs            | Reverse polarity protected<br>Overcurrent protected<br>Short-circuit protected                  |
| Response time                         | ≤ 1,000 $\mu\text{s}$ <sup>2)</sup>   |
| Repeatability (response time)         | 240 $\mu\text{s}$   |
| Switching frequency                   | 500 Hz <sup>3)</sup>  |
| <b>Pin/Wire assignment</b>            |   |
| Function of pin 4/black (BK)          | Digital output, light switching, object present → output $Q_{L1}$ HIGH; IO-Link communication C |
| Function of pin 4/black (BK) – detail | The pin 4 function of the sensor can be configured, Additional possible settings via IO-Link    |
| Function of pin 2/white (WH)          | Digital output, dark switching, object present → output $\bar{Q}_{L1}$ LOW                      |
| Function of pin 2/white (WH) – detail | The pin 2 function of the sensor can be configured, Additional possible settings via IO-Link    |

<sup>1)</sup> Limit values.

<sup>2)</sup> Signal transit time with resistive load in switching mode.

<sup>3)</sup> With light/dark ratio 1:1.

### Mechanical data

|   |                           |
|---|---------------------------|
| <b>Housing</b>  | Rectangular               |
| <b>Dimensions (W x H x D)</b>                         | 16 mm x 40.1 mm x 12.1 mm |
| <b>Connection</b>                                     | Cable, 4-wire, 2 m        |
| <b>Connection detail</b>                              |                           |
| Deep-freeze property                                  | Do not bend below 0 °C    |
| Conductor size  | 0.14 mm <sup>2</sup>      |
| Cable diameter  | ∅ 3.4 mm                  |
| Length of cable (L)                                   | 2 m                       |
| <b>Material</b>                                       |                           |
| Housing   | Plastic, VISTAL®          |
| Front screen  | Plastic, PMMA             |
| Cable   | PVC                       |
| <b>Weight</b>   | Approx. 30 g              |
| <b>Maximum tightening torque of the fixing screws</b> | 0.4 Nm                    |

### Ambient data

|                                      |                                    |
|--------------------------------------|------------------------------------|
| <b>Enclosure rating</b>              | IP66 (EN 60529)<br>IP67 (EN 60529) |
| <b>Ambient operating temperature</b> | -40 °C ... +60 °C                  |

|  |   |
|--|---|
| <b>Ambient temperature, storage</b>        | -40 °C ... +75 °C   |
| <b>Typ. Ambient light immunity</b>         | Artificial light: ≤ 50,000 lx<br>Sunlight: ≤ 50,000 lx  |
| <b>Shock resistance</b>                    | 30 g, 11 ms (3 positive and 3 negative shocks along X, Y, Z axes, 18 total shocks (EN60068-2-27)) |
| <b>Vibration resistance</b>                | 10 Hz ... 1,000 Hz (Amplitude 1 mm, 3 x 30 min (EN60068-2-6))                                     |
| <b>Air humidity</b>                        | 35 % ... 95 %, Relative humidity (no condensation)  |
| <b>Electromagnetic compatibility (EMC)</b> | EN 60947-5-2  |
| <b>Resistance to cleaning agent</b>        | ECOLAB  |
| <b>UL File No.</b>                         | NRKH.E181493 & NRKH7.E181493  |

## Smart Task

|                                  |  |
|----------------------------------|--|
| <b>Smart Task name</b>           | Base logics  |
| <b>Logic function</b>            | Direct<br>AND<br>OR  |
| <b>Timer function</b>            | Deactivated<br>On delay<br>Off delay<br>ON and OFF delay<br>Impulse (one shot) |
| <b>Inverter</b>                  | Yes  |
| <b>Switching frequency</b>       | SIO Logic: 450 Hz <sup>1)</sup><br>IOL: 450 Hz <sup>2)</sup>                   |
| <b>Response time</b>             | SIO Logic: 1100 µs <sup>1)</sup><br>IOL: 1100 µs <sup>2)</sup>                 |
| <b>Repeatability</b>             | SIO Logic: 500 µs <sup>1)</sup><br>IOL: 550 µs <sup>2)</sup>                   |
| <b>Switching signal</b>          |  |
| Switching signal Q <sub>L1</sub> | Switching output   |
| Switching signal $\bar{Q}_{L1}$  | Switching output   |

<sup>1)</sup> Use of Smart Task functions without IO-Link communication (SIO mode).

<sup>2)</sup> Use of Smart Task functions with IO-Link communication function.

## Diagnosis

|  |                                      |
|--|--------------------------------------|
| <b>Device temperature</b>                          |                                      |
| Measuring range                                    | Very cold, cold, moderate, warm, hot |
| <b>Device status</b>                               | Yes                                  |
| <b>Detailed device status</b>                      | Yes                                  |
| <b>Operating hour counter</b>                      | Yes                                  |
| <b>Operating hours counter with reset function</b> | Yes                                  |
| <b>Quality of teach</b>                            | Yes                                  |

## Classifications

|                     |          |
|---------------------|----------|
| <b>eCl@ss 5.0</b>   | 27270904 |
| <b>eCl@ss 5.1.4</b> | 27270904 |
| <b>eCl@ss 6.0</b>   | 27270904 |

|                       |          |
|-----------------------|----------|
| <b>eCl@ss 6.2</b>     | 27270904 |
| <b>eCl@ss 7.0</b>     | 27270904 |
| <b>eCl@ss 8.0</b>     | 27270904 |
| <b>eCl@ss 8.1</b>     | 27270904 |
| <b>eCl@ss 9.0</b>     | 27270904 |
| <b>eCl@ss 10.0</b>    | 27270904 |
| <b>eCl@ss 11.0</b>    | 27270904 |
| <b>eCl@ss 12.0</b>    | 27270903 |
| <b>ETIM 5.0</b>       | EC002719 |
| <b>ETIM 6.0</b>       | EC002719 |
| <b>ETIM 7.0</b>       | EC002719 |
| <b>ETIM 8.0</b>       | EC002719 |
| <b>UNSPSC 16.0901</b> | 39121528 |

## Connection type

Cable, 4-wire

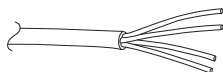

## Connection diagram

Cd-491

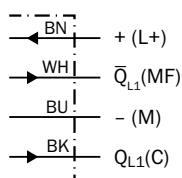

## Truth table

Push-pull: PNP/NPN – dark switching  $\bar{Q}$

|                         | Dark switching $\bar{Q}$ (normally closed (upper switch), normally open (lower switch)) |                             |
|-------------------------|---|-----------------------------|
|                         | Object not present → Output HIGH  | Object present → Output LOW |
| Light receive           | ⊗   | ☑                           |
| Light receive indicator | ⊗   | ☑                           |
| Load resistance to L+   | ⊗   | ☑                           |
| Load resistance to M    | ⚠   | ⊗                           |
|                         |   |                             |

Push-pull: PNP/NPN - light switching Q

|                         | Light switching Q (normally open (upper switch), normally closed (lower switch)) |                              |
|-------------------------|--|------------------------------|
|                         | Object not present → Output LOW  | Object present → Output HIGH |
| Light receive           | ⊗  | ⊙                            |
| Light receive indicator | ⊗  | ⊙                            |
| Load resistance to L+   | ⚠  | ⊗                            |
| Load resistance to M    | ⊗  | ⚠                            |

Characteristic curve

Minimum distance in mm (y) between the set sensing range and white background (90% remission)

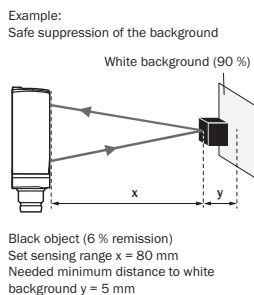
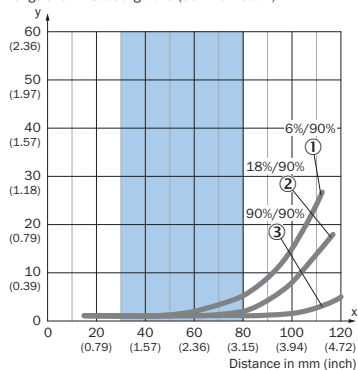

Recommended sensing range for the best performance

- ① Black object, 6% remission factor
- ② Gray object, 18% remission factor
- ③ White object, 90% remission factor

Light spot size

Vertical

Dimensions in mm (inch)

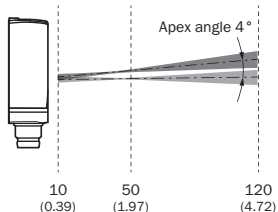
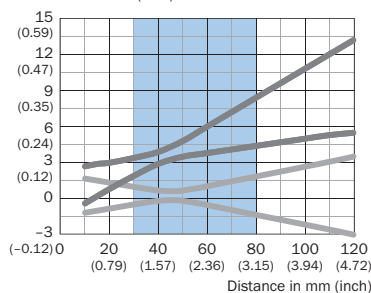

Recommended sensing range for the best performance

### Horizontal

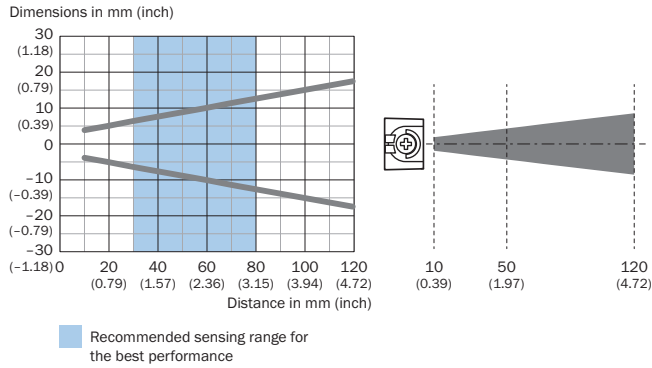

### Sensing range diagram

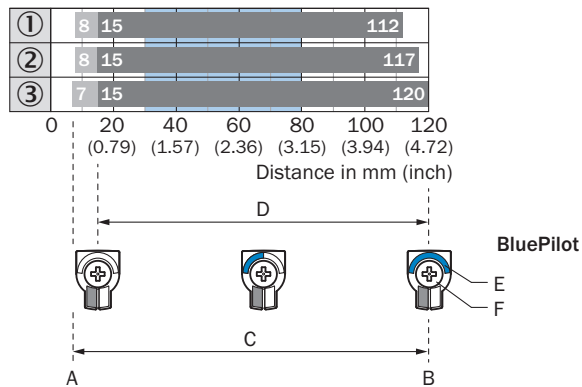

- A = Sensing range min. in mm
- B = Sensing range max. in mm
- C = Viewing range
- D = Adjustable switching threshold for background suppression
- E = Sensing range indicator
- F = Teach-Turn adjustment

Recommended sensing range for the best performance

- ① Black object, 6% remission factor
- ② Gray object, 18% remission factor
- ③ White object, 90% remission factor

## Adjustments

Display and adjustment elements

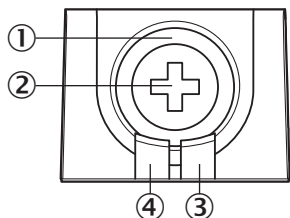

- ① LED blue
- ② Teach-Turn adjustment
- ③ LED yellow
- ④ LED green

## Dimensional drawing (Dimensions in mm (inch))

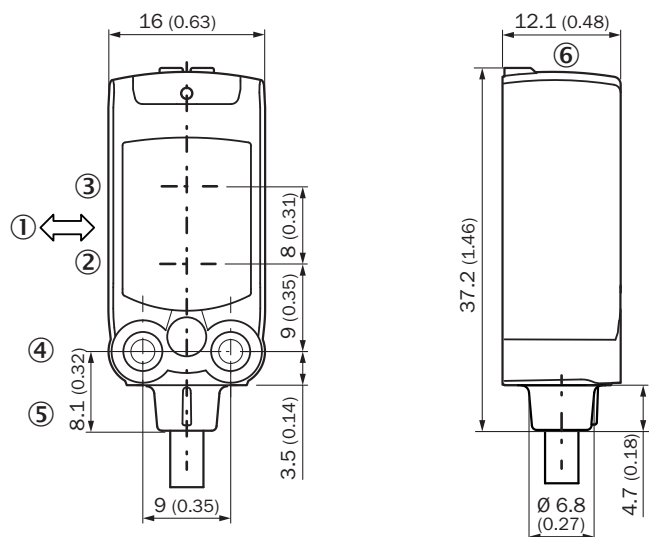

- ① Standard direction of the material being detected
- ② Center of optical axis, sender
- ③ Center of optical axis, receiver
- ④ M3 mounting hole
- ⑤ Connection
- ⑥ Display and adjustment elements

## Recommended accessories

Other models and accessories → [www.sick.com/W4F](http://www.sick.com/W4F)

|   | Brief description  | Type     | Part no. |
|---|--|----------|----------|
| <b>Mounting brackets and plates</b>   |  |          |          |
|  | Mounting bracket for wall mounting, Stainless steel 1.4571, mounting hardware included | BEF-W4-A | 2051628  |

|   | Brief description   | Type       | Part no. |
|---|---|------------|----------|
| Plug connectors and cables  |   |            |          |
|  | Head A: male connector, M12, 4-pin, straight<br>Cable: unshielded | STE-1204-G | 6009932  |

## SICK AT A GLANCE

SICK is one of the leading manufacturers of intelligent sensors and sensor solutions for industrial applications. A unique range of products and services creates the perfect basis for controlling processes securely and efficiently, protecting individuals from accidents and preventing damage to the environment.

We have extensive experience in a wide range of industries and understand their processes and requirements. With intelligent sensors, we can deliver exactly what our customers need. In application centers in Europe, Asia and North America, system solutions are tested and optimized in accordance with customer specifications. All this makes us a reliable supplier and development partner.

Comprehensive services complete our offering: SICK LifeTime Services provide support throughout the machine life cycle and ensure safety and productivity.

For us, that is “Sensor Intelligence.”

## WORLDWIDE PRESENCE:

Contacts and other locations –[www.sick.com](http://www.sick.com)