



# AFS60A-S1EB262144

AFS/AFM60 Ethernet

**ABSOLUTE ENCODERS**

**SICK**  
Sensor Intelligence.



### Ordering information

Type	Part no.
AFS60A-S1EB262144	1059072

Other models and accessories → [www.sick.com/AFS\\_AFM60\\_Ethernet](http://www.sick.com/AFS_AFM60_Ethernet)

Illustration may differ



### Detailed technical data

#### Performance

<b>Number of steps per revolution (max. resolution)</b>	262,144 (18 bit)
<b>Error limits G</b>	0.03° <sup>1)</sup>
<b>Repeatability standard deviation <math>\sigma_r</math></b>	0.002° <sup>2)</sup>

<sup>1)</sup> In accordance with DIN ISO 1319-1, position of the upper and lower error limit depends on the installation situation, specified value refers to a symmetrical position, i.e. deviation in upper and lower direction is the same.

<sup>2)</sup> In accordance with DIN ISO 55350-13; 68.3% of the measured values are inside the specified area.

#### Interfaces

<b>Communication interface</b>	EtherCAT®
<b>Communication Interface detail</b>	CoE (CAN over EtherCAT®)
<b>Encoder profile</b>	CiA DS-406
<b>Data transmission rate (baud rate)</b>	10 Mbit/s 100 Mbit/s
<b>Transmission medium</b>	CAT-5e cable
<b>Initialization time</b>	6 s
<b>Cycle time</b>	125 µs ... 100 ms
<b>Parameterising data</b>	Number of steps per revolution PRESET Counting direction Sampling rate for speed calculation Unit for output of the speed value Singleturn or multiturn access mode Quicker data exchange mode
<b>Available diagnostics data</b>	Minimum and maximum temperature Maximum speed Position monitoring Power-on counter Operating hours counter power-on/motion Counter of direction changes/number of movements cw/number of movements ccw Minimum and maximum operating voltage Signal monitoring for singleturn and multiturn

## Electrical data

<b>Connection type</b>	Male connector, 1x, M12, 4-pin, axial <sup>1)</sup> Female connector, 2x, M12, 4-pin, axial <sup>2)</sup>
<b>Supply voltage</b>	10 ... 30 V
<b>Power consumption</b>	≤ 3 W (without load)
<b>Reverse polarity protection</b>	✓
<b>MTTFd: mean time to dangerous failure</b>	80 years (EN ISO 13849-1) <sup>3)</sup>

<sup>1)</sup> A-coded.

<sup>2)</sup> D-coded.

<sup>3)</sup> This product is a standard product and does not constitute a safety component as defined in the Machinery Directive. Calculation based on nominal load of components, average ambient temperature 40 °C, frequency of use 8760 h/a. All electronic failures are considered hazardous. For more information, see document no. 8015532.

## Mechanical data

<b>Mechanical design</b>	Solid shaft, Servo flange
<b>Shaft diameter</b>	6 mm
<b>Shaft length</b>	10 mm
<b>Weight</b>	0.2 kg
<b>Shaft material</b>	Stainless steel
<b>Flange material</b>	Aluminum
<b>Housing material</b>	Aluminum
<b>Start up torque</b>	0.5 Ncm (+20 °C)
<b>Operating torque</b>	0.3 Ncm (+20 °C)
<b>Permissible shaft load</b>	80 N / radial 40 N / axial
<b>Operating speed</b>	≤ 9,000 min <sup>-1</sup> <sup>1)</sup>
<b>Moment of inertia of the rotor</b>	6.2 gcm <sup>2</sup>
<b>Bearing lifetime</b>	3 x 10 <sup>9</sup> revolutions
<b>Angular acceleration</b>	≤ 500,000 rad/s <sup>2</sup>

<sup>1)</sup> Allow for self-heating of 3.3 K per 1,000 rpm when designing the operating temperature range.

## Ambient data

<b>EMC</b>	According to EN 61000-6-2 and EN 61000-6-3 <sup>1)</sup>
<b>Enclosure rating</b>	IP65, shaft side (IEC 60529) IP67, housing side (IEC 60529) <sup>2)</sup>
<b>Permissible relative humidity</b>	90 % (Condensation not permitted)
<b>Operating temperature range</b>	-40 °C ... +85 °C
<b>Storage temperature range</b>	-40 °C ... +100 °C, without package
<b>Resistance to shocks</b>	100 g, 6 ms (EN 60068-2-27)
<b>Resistance to vibration</b>	30 g, 10 Hz ... 2,000 Hz (EN 60068-2-6)

<sup>1)</sup> The EMC according to the standards quoted is achieved if screened cables are used.

<sup>2)</sup> With mating connector fitted.

## Classifications

<b>eCl@ss 5.0</b>	27270502
-------------------	----------



### Attachment specifications

Mounting requirements for small servo clamp

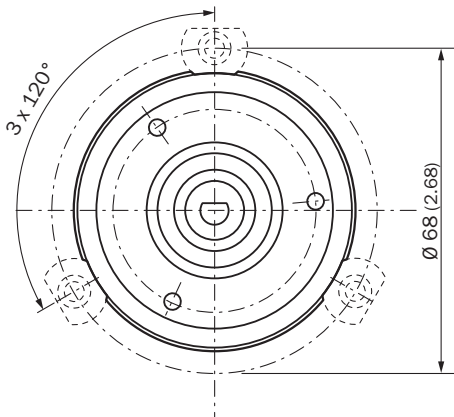

All dimensions in mm (inch)

Mounting requirements for half-shell servo clamp

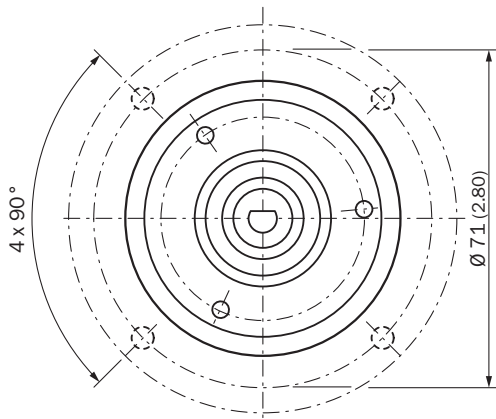

All dimensions in mm (inch)

### PIN assignment

Male connector

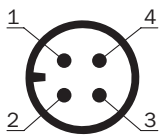

Supply voltage

PIN	Wire color	Signal
1	Brown	U <sub>S</sub> 10 V ... 30 V
2	White	Not assigned
3	Blue	GND
4	Black	Not assigned

Female connector

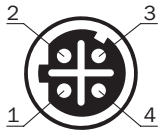

Port 1, Port 2

PIN	Wire color	Signal
1	Yellow	T x D+
2	White	R x D+
3	Orange	T x D-
4	Blue	R x D-



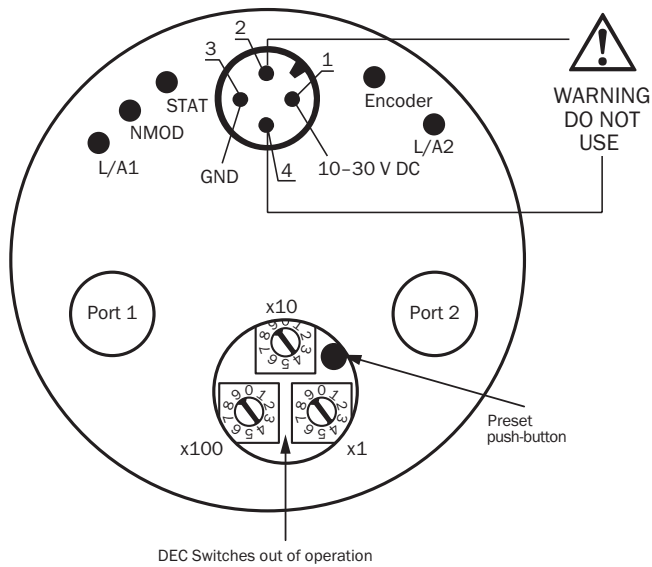





### Connection diagram







### Recommended accessories

Other models and accessories → [www.sick.com/AFS\\_AFM60\\_Ethernet](http://www.sick.com/AFS_AFM60_Ethernet)

	Brief description	Type	Part no.
<b>Flanges</b>			
	Flange adapter, adaptation of face mount flange with 36 mm centering hub to 50 mm servo flange, aluminum, including 3 flat head screws M4 x 10, Aluminum, including 3 countersunk screws M4 x 10	BEF-FA-036-050	2029160
	Flange adapter, adaptation of face mount flange with 36 mm centering hub to 60 mm square mounting plate, aluminum, including 3 flat head screws M4 x 8, Aluminum, including 3 countersunk screws M4 x 8	BEF-FA-036-060REC	2029162

	Brief description	Type	Part no.
	Flange adapter, adaptation of face mount flange with 36 mm centering hub to 58 mm square mounting plate with shock absorbers, aluminum, Aluminum	BEF-FA-036-060RSA	2029163
	Flange adapter, adaptation of face mount flange with 36 mm centering hub to 63 mm square mounting plate, aluminum, including 3 flat head screws M4 x 10, Aluminum, including 3 countersunk screws M4 x 10	BEF-FA-036-063REC	2034225
Other mounting accessories			
	Plastic measuring wheel with smooth plastic surface (Hytrel), for 10 mm solid shaft, circumference 200 mm	BEF-MR-010020	5312988
	Measuring wheel with ridged plastic surface (Hytrel) for 10 mm solid shaft, circumference 200 mm	BEF-MR-010020G	5318678
	Plastic measuring wheel with smooth plastic surface (Hytrel) for 10 mm solid shaft, circumference 500 mm	BEF-MR-010050	5312989
	Aluminium measuring wheel with O-ring (NBR70) for 6 mm solid shaft, circumference 200 mm	BEF-MR006020R	2055222
	Measuring wheel with O-ring (NBR70) for 6 mm solid shaft, circumference 300 mm	BEF-MR006030R	2055634
	Aluminium measuring wheel with O-ring (NBR70) for 10 mm solid shaft, circumference 200 mm	BEF-MR010020R	2055224
	Aluminium measuring wheel with O-ring (NBR70) for 10 mm solid shaft, circumference 300 mm	BEF-MR010030R	2049278
	Measuring wheel with O-ring (NBR70) for 10 mm solid shaft, circumference 500 mm	BEF-MR010050R	2055227
	O-ring for measuring wheels (circumference 200 mm)	BEF-OR-053-040	2064061
	O-ring for measuring wheels (circumference 300 mm), 2x O-ring	BEF-OR-083-050	2064076
	Mounting bell for encoder with servo flange, 50 mm spigot, mounting kit included	BEF-MG-50	5312987
	Half-shell servo clamps (2 pcs.) for servo flanges with a 50 mm centering hub	BEF-WG-SF050	2029165
	Servo clamps, large, for servo flanges (clamps, eccentric fastener), 3 pcs., without mounting material, without mounting hardware	BEF-WK-SF	2029166
Plug connectors and cables			
	Head A: male connector, M12, 4-pin, straight, D-coded Head B: Flying leads Cable: PROFINET, PVC, shielded, 2 m	STL-1204-G02MZ90	6048247
	Head A: male connector, M12, 4-pin, straight, D-coded Head B: Flying leads Cable: PROFINET, PVC, shielded, 5 m	STL-1204-G05MZ90	6048248
	Head A: male connector, M12, 4-pin, straight, D-coded Head B: Flying leads Cable: PROFINET, PVC, shielded, 10 m	STL-1204-G10MZ90	6048249
	Head A: male connector, M12, 4-pin, angled, D-coded Head B: Flying leads Cable: PROFINET, PVC, shielded, 2 m	STL-1204-W02MZ90	6048256
	Head A: male connector, M12, 4-pin, angled, D-coded Head B: Flying leads Cable: PROFINET, PVC, shielded, 5 m	STL-1204-W05MZ90	6048257

	Brief description	Type	Part no.
	Head A: male connector, M12, 4-pin, angled, D-coded Head B: Flying leads Cable: PROFINET, PVC, shielded, 10 m	STL-1204-W10MZ90	6048258
	Head A: male connector, M12, 4-pin, angled, D-coded Head B: Flying leads Cable: PROFINET, PVC, shielded, 25 m	STL-1204-W25MZ90	6048259
	Head A: female connector, M12, 4-pin, straight, A-coded Head B: Flying leads Cable: Sensor/actuator cable, PUR, halogen-free, unshielded, 2 m	YF2A14-020UB3XLEAX	2095607
	Head A: female connector, M12, 4-pin, straight, A-coded Head B: Flying leads Cable: Sensor/actuator cable, PUR, halogen-free, unshielded, 5 m	YF2A14-050UB3XLEAX	2095608
	Head A: female connector, M12, 4-pin, straight, A-coded Head B: Flying leads Cable: Sensor/actuator cable, PUR, halogen-free, unshielded, 10 m	YF2A14-100UB3XLEAX	2095609
	Head A: female connector, M12, 4-pin, straight, A-coded Head B: Flying leads Cable: Sensor/actuator cable, PUR, halogen-free, unshielded, 25 m	YF2A14-250UB3XLEAX	2095615
	Head A: female connector, M12, 4-pin, angled, A-coded Head B: Flying leads Cable: Sensor/actuator cable, PUR, halogen-free, unshielded, 2 m	YG2A14-020UB3XLEAX	2095766
	Head A: female connector, M12, 4-pin, angled, A-coded Head B: Flying leads Cable: Sensor/actuator cable, PUR, halogen-free, unshielded, 5 m	YG2A14-050UB3XLEAX	2095767
	Head A: female connector, M12, 4-pin, angled, A-coded Head B: Flying leads Cable: Sensor/actuator cable, PUR, halogen-free, unshielded, 10 m	YG2A14-100UB3XLEAX	2095768
	Head A: female connector, M12, 4-pin, angled, A-coded Head B: Flying leads Cable: Sensor/actuator cable, PUR, halogen-free, unshielded, 25 m	YG2A14-250UB3XLEAX	2095771
	Head A: male connector, M12, 4-pin, angled, D-coded Head B: male connector, M12, 4-pin, straight, D-coded Cable: PROFINET, PVC, shielded, 2 m	SSL-1204-F02MZ90	6048250
	Head A: male connector, M12, 4-pin, angled, D-coded Head B: male connector, M12, 4-pin, straight, D-coded Cable: PROFINET, PVC, shielded, 5 m	SSL-1204-F05MZ90	6048251
	Head A: male connector, M12, 4-pin, angled, D-coded Head B: male connector, M12, 4-pin, straight, D-coded Cable: PROFINET, PVC, shielded, 10 m	SSL-1204-F10MZ90	6048252
	Head A: male connector, M12, 4-pin, straight, D-coded Head B: male connector, M12, 4-pin, straight, D-coded Cable: PROFINET, PVC, shielded, 2 m	SSL-1204-G02MZ90	6048241
	Head A: male connector, M12, 4-pin, straight, D-coded Head B: male connector, M12, 4-pin, straight, D-coded Cable: PROFINET, PVC, shielded, 5 m	SSL-1204-G05MZ90	6048242
	Head A: male connector, M12, 4-pin, straight, D-coded Head B: male connector, M12, 4-pin, straight, D-coded Cable: PROFINET, PVC, shielded, 10 m	SSL-1204-G10MZ90	6048243
	Head A: male connector, M12, 4-pin, angled, D-coded Head B: male connector, M12, 4-pin, angled, D-coded Cable: PROFINET, PUR, halogen-free, shielded, 2 m	SSL-1204-W02MZ	6050635
	Head A: male connector, M12, 4-pin, angled, D-coded Head B: male connector, M12, 4-pin, angled, D-coded Cable: PROFINET, PUR, halogen-free, shielded, 5 m	SSL-1204-W05MZ	6050636

	Brief description	Type	Part no.
	Head A: male connector, M12, 4-pin, angled, D-coded Head B: male connector, M12, 4-pin, angled, D-coded Cable: PROFINET, EtherCAT®, PUR, halogen-free, shielded, 10 m	SSL-1204-W10MZ	6050637
	Head A: male connector, RJ45, 4-pin, straight Head B: male connector, M12, 4-pin, angled, D-coded Cable: PROFINET, EtherCAT®, PVC, shielded, 2 m	SSL-2J04-F02MZ	6048253
	Head A: male connector, RJ45, 4-pin, straight Head B: male connector, M12, 4-pin, angled, D-coded Cable: PROFINET, EtherCAT®, PVC, shielded, 5 m	SSL-2J04-F05MZ	6048254
	Head A: male connector, RJ45, 4-pin, straight Head B: male connector, M12, 4-pin, angled, D-coded Cable: PROFINET, EtherCAT®, PVC, shielded, 10 m	SSL-2J04-F10MZ	6048255
	Head A: male connector, RJ45, 4-pin, straight Head B: male connector, M12, 4-pin, angled, D-coded Cable: PROFINET, EtherCAT®, PVC, shielded, 30 m	SSL-2J04-F30MZ	6059450
	Head A: male connector, M12, 4-pin, straight, D-coded Head B: male connector, RJ45, 4-pin, straight Cable: PROFINET, PVC, shielded, 2 m	SSL-2J04-G02MZ60	6048244
	Head A: male connector, M12, 4-pin, straight, D-coded Head B: male connector, RJ45, 4-pin, straight Cable: PROFINET, PVC, shielded, 5 m	SSL-2J04-G05MZ60	6048245
	Head A: male connector, M12, 4-pin, straight, D-coded Head B: male connector, RJ45, 4-pin, straight Cable: PROFINET, PVC, shielded, 10 m	SSL-2J04-G10MZ60	6048246
	Head A: female connector, M12, 4-pin, straight, D-coded Cable: PROFINET, shielded	DOS-1204-GZ	6048263
	Head A: female connector, M12, 4-pin, angled Cable: unshielded	DOS-1204-W	6007303
	Head A: female connector, M12, 4-pin, angled, D-coded Cable: PROFINET, shielded	DOS-1204-WZ	6048264
	Head A: male connector, RJ45, 4-pin, straight Cable: Ethernet, PROFINET, EtherCAT®, shielded	STE-0J04-GZ	6048260
	Head A: male connector, M12, 4-pin, straight, D-coded Cable: PROFINET, shielded	STE-1204-GZ	6048261
	Head A: male connector, M12, 4-pin, angled, D-coded Cable: PROFINET, shielded	STE-1204-WZ	6048262
	Head A: female connector, M12, 4-pin, D-coded Head B: female connector, RJ45, 8-pin Cable: Ethernet, shielded Cabinet through	Feedthrough female connector Ethernet RJ45	6048180

## SICK AT A GLANCE

SICK is one of the leading manufacturers of intelligent sensors and sensor solutions for industrial applications. A unique range of products and services creates the perfect basis for controlling processes securely and efficiently, protecting individuals from accidents and preventing damage to the environment.

We have extensive experience in a wide range of industries and understand their processes and requirements. With intelligent sensors, we can deliver exactly what our customers need. In application centers in Europe, Asia and North America, system solutions are tested and optimized in accordance with customer specifications. All this makes us a reliable supplier and development partner.

Comprehensive services complete our offering: SICK LifeTime Services provide support throughout the machine life cycle and ensure safety and productivity.

For us, that is “Sensor Intelligence.”

## WORLDWIDE PRESENCE:

Contacts and other locations –[www.sick.com](http://www.sick.com)