



# IME12-04BPSZT0K

IME

INDUCTIVE PROXIMITY SENSORS

**SICK**  
Sensor Intelligence.



### Ordering information

Type	Part no.
IME12-04BPSZTOK	1042973

**Included in delivery:** BEF-MU-M12 (1)

Other models and accessories → [www.sick.com/IME](http://www.sick.com/IME)

Illustration may differ



### Detailed technical data

#### Features

<b>Housing</b>	Cylindrical thread design
<b>Housing</b>	Short-body
<b>Thread size</b>	M12 x 1
<b>Diameter</b>	Ø 12 mm
<b>Sensing range <math>S_n</math></b>	4 mm
<b>Safe sensing range <math>S_a</math></b>	3.24 mm
<b>Installation type</b>	Flush
<b>Switching frequency</b>	2,000 Hz
<b>Connection type</b>	Connector M8, 3-pin
<b>Switching output</b>	PNP
<b>Output function</b>	NO
<b>Electrical wiring</b>	DC 3-wire
<b>Enclosure rating</b>	IP67 <sup>1)</sup>

<sup>1)</sup> According to EN 60529.

#### Mechanics/electronics

<b>Supply voltage</b>	10 V DC ... 30 V DC
<b>Ripple</b>	≤ 10 %
<b>Voltage drop</b>	≤ 2 V <sup>1)</sup>
<b>Time delay before availability</b>	≤ 100 ms
<b>Hysteresis</b>	5 % ... 15 %

<sup>1)</sup> At  $I_a$  max.

<sup>2)</sup>  $U_b$  and  $T_a$  constant.

<sup>3)</sup> Of  $S_r$ .

<b>Reproducibility</b>	≤ 2 % <sup>2) 3)</sup>
<b>Temperature drift (of S<sub>r</sub>)</b>	± 10 %
<b>EMC</b>	According to EN 60947-5-2
<b>Continuous current I<sub>a</sub></b>	≤ 200 mA
<b>Short-circuit protection</b>	✓
<b>Reverse polarity protection</b>	✓
<b>Power-up pulse protection</b>	✓
<b>Shock and vibration resistance</b>	30 g, 11 ms/10 Hz ... 55 Hz, 1 mm
<b>Ambient operating temperature</b>	-25 °C ... +75 °C
<b>Housing material</b>	Brass, nickel-plated
<b>Sensing face material</b>	Plastic, PA 66
<b>Housing length</b>	44 mm
<b>Thread length</b>	28 mm
<b>Tightening torque, max.</b>	≤ 12 Nm
<b>Items supplied</b>	Mounting nut, brass, nickel-plated (2x)
<b>UL File No.</b>	NRKH.E181493

<sup>1)</sup> At I<sub>a</sub> max.

<sup>2)</sup> U<sub>b</sub> and T<sub>a</sub> constant.

<sup>3)</sup> Of S<sub>r</sub>.

#### Safety-related parameters

<b>MTTF<sub>D</sub></b>	1,735 years
<b>DC<sub>avg</sub></b>	0 %

#### Reduction factors

<b>Note</b>	The values are reference values which may vary
<b>St37 steel (Fe)</b>	1
<b>Stainless steel (V2A, 304)</b>	Approx. 0.8
<b>Aluminum (Al)</b>	Approx. 0.45
<b>Copper (Cu)</b>	Approx. 0.4
<b>Brass (Br)</b>	Approx. 0.4

#### Installation note

<b>Remark</b>	Associated graphic see "Installation"
<b>B</b>	24 mm
<b>C</b>	12 mm
<b>D</b>	12 mm
<b>F</b>	32 mm

#### Classifications

<b>ECl@ss 5.0</b>	27270101
<b>ECl@ss 5.1.4</b>	27270101
<b>ECl@ss 6.0</b>	27270101
<b>ECl@ss 6.2</b>	27270101

<b>ECl@ss 7.0</b>	27270101
<b>ECl@ss 8.0</b>	27270101
<b>ECl@ss 8.1</b>	27270101
<b>ECl@ss 9.0</b>	27270101
<b>ECl@ss 10.0</b>	27270101
<b>ECl@ss 11.0</b>	27270101
<b>ETIM 5.0</b>	EC002714
<b>ETIM 6.0</b>	EC002714
<b>ETIM 7.0</b>	EC002714
<b>ETIM 8.0</b>	EC002714
<b>UNSPSC 16.0901</b>	39122230

### Installation note

Flush installation

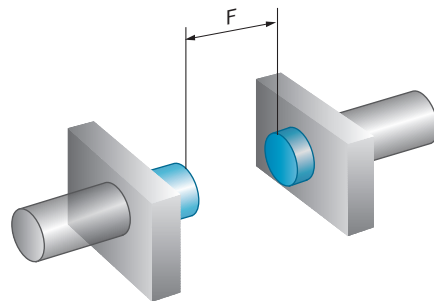
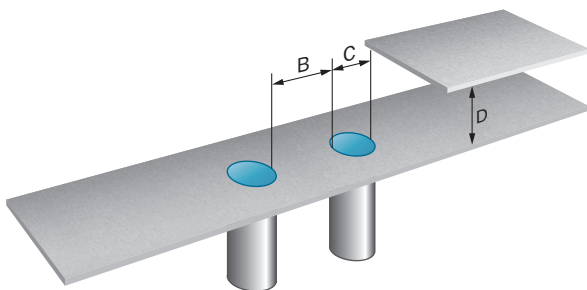

### Connection type

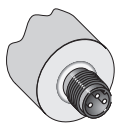

### Connection diagram

Cd-002

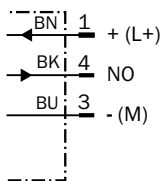

Dimensional drawing (Dimensions in mm (inch))

IME12 Short-body housing, connector, flush

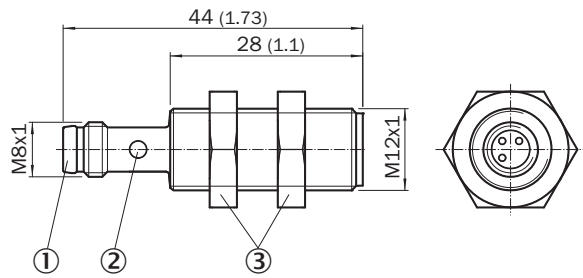



- ① Connection
- ② Display LED
- ③ Fastening nuts (2x); width across 17, metal

Recommended accessories

Other models and accessories → [www.sick.com/IME](http://www.sick.com/IME)

	Brief description	Type	Part no.
<b>Mounting brackets and plates</b>			
	Mounting plate for M12 sensors, steel, zinc coated, without mounting hardware	BEF-WG-M12	5321869
	Mounting bracket for M12 sensors, steel, zinc coated, without mounting hardware	BEF-WN-M12	5308447
<b>Plug connectors and cables</b>			
	Head A: female connector, M8, 3-pin, straight, A-coded Head B: Flying leads Cable: Sensor/actuator cable, PVC, unshielded, 2 m	YF8U13-020VA1XLEAX	2095860
	Head A: female connector, M8, 3-pin, straight, A-coded Head B: Flying leads Cable: Sensor/actuator cable, PVC, unshielded, 5 m	YF8U13-050VA1XLEAX	2095884
	Head A: female connector, M8, 3-pin, straight, A-coded Head B: Flying leads Cable: Sensor/actuator cable, PVC, unshielded, 10 m	YF8U13-100VA1XLEAX	2095885
	Head A: female connector, M8, 3-pin, angled, A-coded Head B: Flying leads Cable: Sensor/actuator cable, PVC, unshielded, 2 m	YG8U13-020VA1XLEAX	2096165
	Head A: female connector, M8, 3-pin, angled, A-coded Head B: Flying leads Cable: Sensor/actuator cable, PVC, unshielded, 5 m	YG8U13-050VA1XLEAX	2096166
	Head A: female connector, M8, 3-pin, angled, A-coded Head B: Flying leads Cable: Sensor/actuator cable, PVC, unshielded, 10 m	YG8U13-100VA1XLEAX	2096209
	Head A: female connector, M8, 3-pin, straight Head B: - Cable: unshielded	DOS-0803-G	7902077

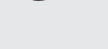
	<b>Brief description</b>	<b>Type</b>	<b>Part no.</b>
	Head A: female connector, M8, 3-pin, angled Head B: - Cable: unshielded	DOS-0803-W	7902078
<b>Terminal and alignment brackets</b>			
	Clamping block for round sensors M12, without fixed stop, plastic (PA12), glass-fiber reinforced, mounting hardware included	BEF-KH-M12	2051479
	Clamping block for round sensors M12, with fixed stop, plastic (PA12), glass-fiber reinforced, mounting hardware included	BEF-KHF-M12	2051480

## SICK AT A GLANCE

SICK is one of the leading manufacturers of intelligent sensors and sensor solutions for industrial applications. A unique range of products and services creates the perfect basis for controlling processes securely and efficiently, protecting individuals from accidents and preventing damage to the environment.

We have extensive experience in a wide range of industries and understand their processes and requirements. With intelligent sensors, we can deliver exactly what our customers need. In application centers in Europe, Asia and North America, system solutions are tested and optimized in accordance with customer specifications. All this makes us a reliable supplier and development partner.

Comprehensive services complete our offering: SICK LifeTime Services provide support throughout the machine life cycle and ensure safety and productivity.

For us, that is “Sensor Intelligence.”

## WORLDWIDE PRESENCE:

Contacts and other locations –[www.sick.com](http://www.sick.com)