



WTB4S-3P2162

W4S-3

MINIATURE PHOTOELECTRIC SENSORS

SICK
Sensor Intelligence.



Illustration may differ



Ordering information

Type	Part no.
WTB4S-3P2162	1042037

Other models and accessories → www.sick.com/W4S-3

Detailed technical data

Features

Device type	Photoelectric sensors
Sensor/ detection principle	Photoelectric proximity sensor, Background suppression
Dimensions (W x H x D)	12.2 mm x 41.8 mm x 17.3 mm
Housing design (light emission)	Rectangular
Sensing range max.	4 mm ... 150 mm ¹⁾
Sensing range	15 mm ... 150 mm ¹⁾
Type of light	Visible red light
Light source	PinPoint LED ²⁾
Light spot size (distance)	Ø 6.5 mm (150 mm)
Wave length	650 nm
Adjustment	Single teach-in button

¹⁾ Object with 90 % reflectance (referred to standard white, DIN 5033).

²⁾ Average service life: 100,000 h at T_U = +25 °C.

Mechanics/electronics

Supply voltage	10 V DC ... 30 V DC ¹⁾
Ripple	< 5 V _{pp} ²⁾
Current consumption	20 mA ³⁾
Switching output	PNP
Switching mode	Light switching
Output current I_{max.}	≤ 100 mA
Response time	< 0.5 ms ⁴⁾
Switching frequency	1,000 Hz ⁵⁾
Connection type	Connector M8, 3-pin
Circuit protection	A ⁶⁾ C ⁷⁾ D ⁸⁾
Protection class	III
Weight	30 g
Housing material	Plastic, ABS
Optics material	Plastic, PMMA
Enclosure rating	IP67 IP66
Ambient operating temperature	-40 °C ... +60 °C
Ambient temperature, storage	-40 °C ... +75 °C
UL File No.	NRKH.E181493 & NRKH7.E181493

1) Limit values.

2) May not exceed or fall below U_v tolerances.

3) Without load.

4) Signal transit time with resistive load.

5) With light/dark ratio 1:1.

6) A = V_S connections reverse-polarity protected.

7) C = interference suppression.

8) D = outputs overcurrent and short-circuit protected.

Classifications

ECl@ss 5.0	27270904
ECl@ss 5.1.4	27270904
ECl@ss 6.0	27270904
ECl@ss 6.2	27270904
ECl@ss 7.0	27270904
ECl@ss 8.0	27270904
ECl@ss 8.1	27270904
ECl@ss 9.0	27270904
ECl@ss 10.0	27270904
ECl@ss 11.0	27270904
ETIM 5.0	EC002719
ETIM 6.0	EC002719

ETIM 7.0	EC002719
ETIM 8.0	EC002719
UNSPSC 16.0901	39121528

Connection type

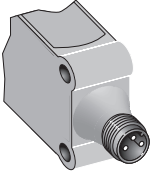

Connection diagram

Cd-045

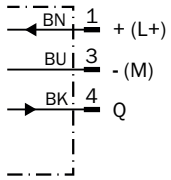

Characteristic curve

WTB4S-3, 180 mm

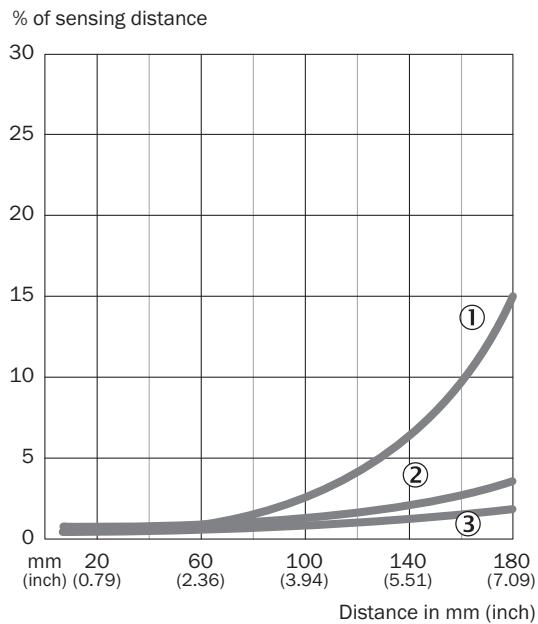

- ① Sensing range on black, 6% remission
- ② Sensing range on gray, 18 % remission
- ③ Sensing range on white, 90% remission

Sensing range diagram

WTB4S-3, 180 mm

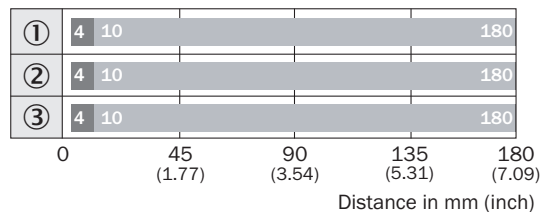

■ Sensing range max. ■ Sensing range

- ① Sensing range on black, 6% remission
- ② Sensing range on gray, 18 % remission
- ③ Sensing range on white, 90% remission

Dimensional drawing (Dimensions in mm (inch))

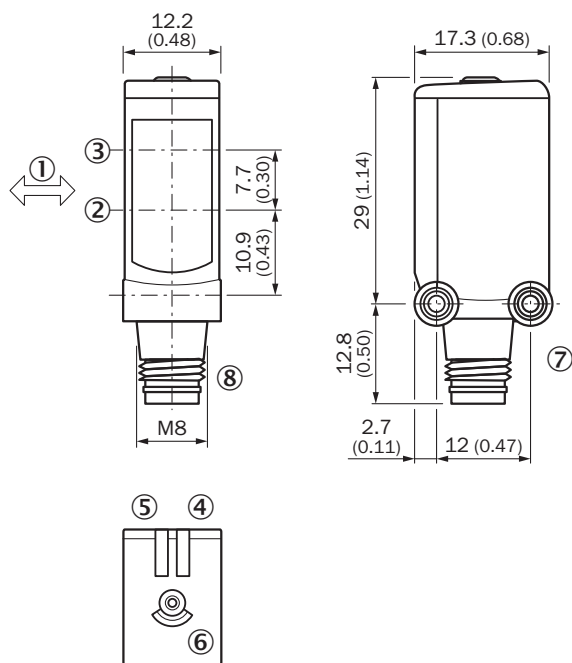

WTB4S-3, Single teach-in button



- ① Standard direction of the material being detected
- ② Optical axis, receiver
- ③ Optical axis, sender
- ④ LED indicator green: Supply voltage active
- ⑤ LED indicator yellow: Status of received light beam
- ⑥ Teach-in button
- ⑦ Threaded mounting hole M3
- ⑧ Connection

Recommended accessories

Other models and accessories → www.sick.com/W4S-3

	Brief description	Type	Part no.
Mounting brackets and plates			
	Mounting bracket for wall mounting, Stainless steel 1.4571, mounting hardware included	BEF-W4-A	2051628
Plug connectors and cables			
	Head A: female connector, M8, 3-pin, straight, A-coded Head B: Flying leads Cable: Sensor/actuator cable, PVC, unshielded, 5 m	YF8U13-050VA1XLEAX	2095884
	Head A: male connector, M8, 3-pin, straight Head B: - Cable: unshielded	STE-0803-G	6037322

SICK AT A GLANCE

SICK is one of the leading manufacturers of intelligent sensors and sensor solutions for industrial applications. A unique range of products and services creates the perfect basis for controlling processes securely and efficiently, protecting individuals from accidents and preventing damage to the environment.

We have extensive experience in a wide range of industries and understand their processes and requirements. With intelligent sensors, we can deliver exactly what our customers need. In application centers in Europe, Asia and North America, system solutions are tested and optimized in accordance with customer specifications. All this makes us a reliable supplier and development partner.

Comprehensive services complete our offering: SICK LifeTime Services provide support throughout the machine life cycle and ensure safety and productivity.

For us, that is “Sensor Intelligence.”

WORLDWIDE PRESENCE:

Contacts and other locations –www.sick.com