



GTB6-F4421V

G6

MINIATURE PHOTOELECTRIC SENSORS

SICK
Sensor Intelligence.



Illustration may differ

ECOLAB



Ordering information

Type	Part no.
GTB6-F4421V	1084093

Other models and accessories → www.sick.com/G6

Detailed technical data

Features

Functional principle	Photoelectric proximity sensor	
Functional principle detail	Background suppression	
Sensing range max.	5 mm ... 420 mm ¹⁾	
Sensing range	50 mm ... 200 mm	
Emitted beam	Light source	LED ²⁾
	Type of light	Infrared light
	Light spot size (distance)	Ø 8 mm (100 mm)
Key LED figures	Wave length	850 nm
	Adjustment	Mechanical spindle, 5 turns
Special applications	Hygienic and washdown zones	

¹⁾ Object with 90% remission (based on standard white, DIN 5033).

²⁾ Average service life: 100,000 h at T_U = +25 °C.

Electronics

Supply voltage U_B	10 V DC ... 30 V DC ¹⁾
Ripple	± 10 % ²⁾

¹⁾ Limit values when operated in short-circuit protected network: max. 8 A.

²⁾ May not fall below or exceed U_V tolerances.

³⁾ Without load.

⁴⁾ At U_v > 24 V, I_A max. = 50 mA.

⁵⁾ Signal transit time with resistive load.

⁶⁾ With light/dark ratio 1:1.

⁷⁾ A = V_S connections reverse-polarity protected.

⁸⁾ B = inputs and output reverse-polarity protected.

⁹⁾ D = outputs overcurrent and short-circuit protected.

Current consumption	30 mA ³⁾
Protection class	III
Digital output	
Type	PNP
Switching mode	Light/dark switching
Signal voltage PNP HIGH/LOW	$V_S - (\leq 3 \text{ V}) / \text{approx. } 0 \text{ V}$
Output current I_{max}	$\leq 100 \text{ mA}$ ⁴⁾
Response time	$< 1.25 \text{ ms}$ ⁵⁾
Switching frequency	500 Hz ⁶⁾
Output function	Complementary switching output
Circuit protection	A ⁷⁾ B ⁸⁾ D ⁹⁾

¹⁾ Limit values when operated in short-circuit protected network: max. 8 A.

²⁾ May not fall below or exceed U_V tolerances.

³⁾ Without load.

⁴⁾ At $U_V > 24 \text{ V}$, $I_A \text{ max.} = 50 \text{ mA}$.

⁵⁾ Signal transit time with resistive load.

⁶⁾ With light/dark ratio 1:1.

⁷⁾ A = V_S connections reverse-polarity protected.

⁸⁾ B = inputs and output reverse-polarity protected.

⁹⁾ D = outputs overcurrent and short-circuit protected.

Mechanics

Housing	Rectangular
Dimensions (W x H x D)	15 mm x 44 mm x 22 mm
Connection	Male connector M8, 4-pin
Material	
Housing	Metal, Stainless steel V4A (1.4404, 316L)
Front screen	Plastic, PMMA
Weight	40 g

Ambient data

Enclosure rating	IP67 IP69K ¹⁾
Ambient operating temperature	$-25 \text{ }^\circ\text{C} \dots +55 \text{ }^\circ\text{C}$ ²⁾
Ambient temperature, storage	$-30 \text{ }^\circ\text{C} \dots +75 \text{ }^\circ\text{C}$
UL File No.	NRKH.E348498 & NRKH7.E348498

¹⁾ According to ISO 20653:2013-03.

²⁾ Temperature stability following adjustment $\pm 10 \text{ }^\circ\text{C}$.

Classifications

ECLASS 5.0	27270904
ECLASS 5.1.4	27270904
ECLASS 6.0	27270904
ECLASS 6.2	27270904

ECLASS 7.0	27270904
ECLASS 8.0	27270904
ECLASS 8.1	27270904
ECLASS 9.0	27270904
ECLASS 10.0	27270904
ECLASS 11.0	27270904
ECLASS 12.0	27270903
ETIM 5.0	EC002719
ETIM 6.0	EC002719
ETIM 7.0	EC002719
ETIM 8.0	EC002719
UNSPSC 16.0901	39121528

Dimensional drawing (Dimensions in mm (inch))

GTB6, GTE6, GL6, GSE6 Inox, male connector

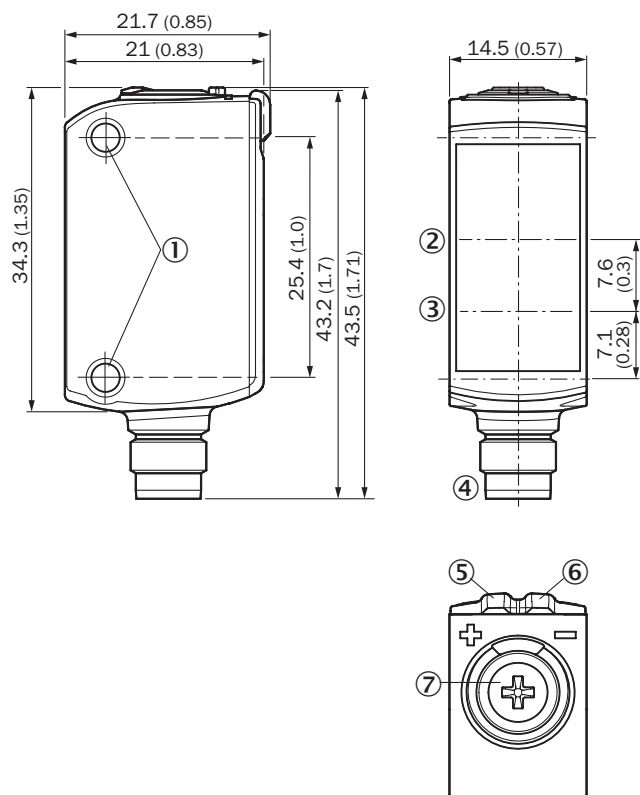

- ① M3 mounting hole
- ② Optical axis, receiver
- ③ Optical axis, sender
- ④ Connection
- ⑤ LED indicator yellow: Status of received light beam
- ⑥ LED indicator green: Supply voltage active
- ⑦ Potentiometer

Connection diagram

Cd-084

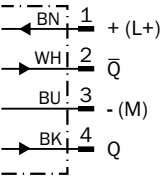

Characteristic curve

GTB6 Inox, IR, Standard

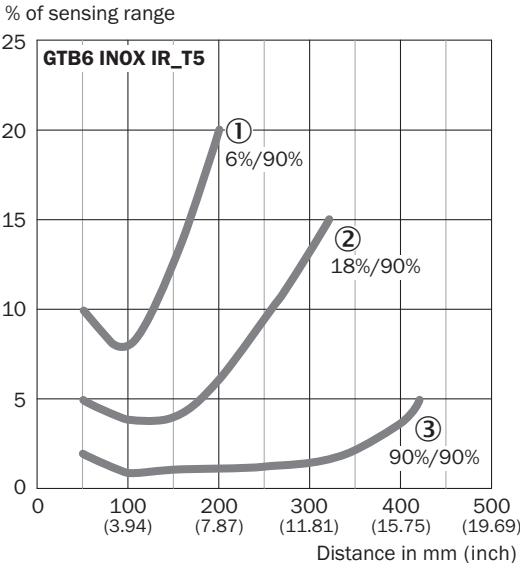

- ① Sensing range on black, 6% remission factor
- ② Sensing range on gray, 18% remission factor
- ③ Sensing range on white, 90% remission factor

Light spot size

GTB6 Inox, IR, Standard

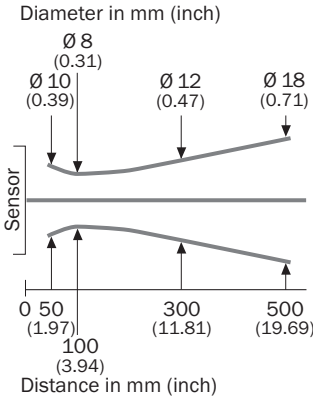

Sensing range diagram

GTB6 Inox, IR, Standard

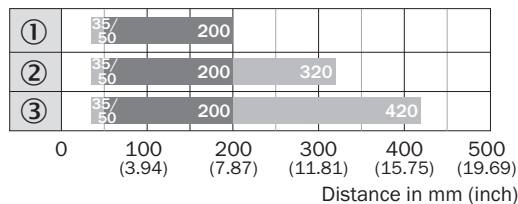



■ Sensing range ■ Sensing range max.

- ① Sensing range on black, 6% remission factor
- ② Sensing range on gray, 18% remission factor
- ③ Sensing range on white, 90% remission factor

Recommended accessories

Other models and accessories → www.sick.com/G6

	Brief description	Type	Part no.
Mounting brackets and plates			
	<ul style="list-style-type: none"> • Description: Mounting bracket for wall mounting • Material: Stainless steel • Details: Stainless steel • Items supplied: Mounting hardware included • Suitable for: W8, W8G, W8 Laser, W8 Inox, G6, G6 Inox, W100 Laser, W100-2, KTM Core, KTM Prime, CSM, LUTM, W4S 	BEF-W100-A	5311520
Universal bar clamp systems			
	<ul style="list-style-type: none"> • Description: Clamp bar to fix G6 sensors on rods of 12 mm, clamp-on design up to 4 mm wall thickness • Material: Steel • Details: Aluminum (clamp bar), stainless steel (bracket) • Items supplied: Clamp bar mounting and clamp function, mounting bracket, mounting hardware 	BEF-KHS-IS12G6	2086865
Others			
	<ul style="list-style-type: none"> • Connection type head A: Female connector, M8, 4-pin, straight • Connection type head B: Flying leads • Signal type: Sensor/actuator cable • Cable: 5 m, 4-wire, PVC • Description: Sensor/actuator cable, unshielded • Connection systems: Flying leads • Note: This product is generally resistant to chemical cleaning agents (see ECOLAB). Please do not use cleaning agents of any other Kind., Not resistant against lactic acid & hydrogen peroxide (H2O2) • Application: Hygienic and washdown zones 	DOL-0804-G05MNI	6059194

SICK AT A GLANCE

SICK is one of the leading manufacturers of intelligent sensors and sensor solutions for industrial applications. A unique range of products and services creates the perfect basis for controlling processes securely and efficiently, protecting individuals from accidents and preventing damage to the environment.

We have extensive experience in a wide range of industries and understand their processes and requirements. With intelligent sensors, we can deliver exactly what our customers need. In application centers in Europe, Asia and North America, system solutions are tested and optimized in accordance with customer specifications. All this makes us a reliable supplier and development partner.

Comprehensive services complete our offering: SICK LifeTime Services provide support throughout the machine life cycle and ensure safety and productivity.

For us, that is “Sensor Intelligence.”

WORLDWIDE PRESENCE:

Contacts and other locations –www.sick.com