



UFS3-37N115

UFS

FORK SENSORS

SICK
Sensor Intelligence.



Illustration may differ

Ordering information

Type	Part no.
UFS3-37N115	6075490

Other models and accessories → www.sick.com/UFS



Detailed technical data

Features

Functional principle	Ultrasonic detection principle
Dimensions (W x H x D)	20 mm x 37.4 mm x 70 mm
Housing design	Fork shaped
Fork width	2.6 mm
Fork depth	42.5 mm
Minimum detectable object (MDO)	Label size: 2 mm ¹⁾ Label gap: 1 mm ¹⁾
Label detection	✓
Adjustment	Plus/minus button, cable (Teach-in, sensitivity, light/dark switching, Teach-in dynamic)
Teach-in mode	1-point teach-in 2-point teach-in Teach-in dynamic

¹⁾ Depends on the label thickness.

Mechanics/electronics

Supply voltage	10 V DC ... 30 V DC ¹⁾
Ripple	< 10 % ²⁾

¹⁾ Limit values, reverse-polarity protected, operation in short-circuit protected network: max. 8 A.

²⁾ May not fall below or exceed U_V tolerances.

³⁾ Without load.

⁴⁾ With light/dark ratio 1:1.

⁵⁾ Signal transit time with resistive load.

⁶⁾ Output current minimal 0.03 mA.

⁷⁾ Reference voltage DC 50 V.

Current consumption	50 mA ³⁾
Switching frequency	1.1 kHz ⁴⁾
Response time	440 µs ⁵⁾
Jitter	40 µs
Switching output	NPN
Switching output (voltage)	NPN: HIGH = V _S / LOW ≤ 3 V
Switching mode	Light/dark switching
Output current I_{max.}	100 mA ⁶⁾
Input, teach-in (ET)	Teach: U < 2 V: Run: U = 10 V ... < U _V
Initialization time	100 ms
Connection type	Cable open end, 4-wire, 2 m
Cable diameter	Ø 3.5 mm
Protection class	III ⁷⁾
Circuit protection	U _V connections, reverse polarity protected Output Q short-circuit protected Interference pulse suppression
Enclosure rating	IP65
Weight	Approx. 100 g
Housing material	Zamak Glass fiber reinforced plastic
Indication	LED indicator green: power on LED indicator, yellow: Status switching output Q

¹⁾ Limit values, reverse-polarity protected, operation in short-circuit protected network: max. 8 A.

²⁾ May not fall below or exceed U_V tolerances.

³⁾ Without load.

⁴⁾ With light/dark ratio 1:1.

⁵⁾ Signal transit time with resistive load.

⁶⁾ Output current minimal 0.03 mA.

⁷⁾ Reference voltage DC 50 V.

Communication interface

IO-Link	✓, V1.1
Data transmission rate	COM3 (230,4 kBaud)
Cycle time	4 ms
VendorID	26
DeviceID HEX	0x8002A6
DeviceID DEC	8389286
Process data length	16 Bit
Process data structure A	Bit 0 = switching signal Q _{L1} Bit 1 = switching signal Q _{L2} Bit 2 = switching signal Q _{Int1} Bit 3 = switching signal Q _{Int2} Bit 4 = alarm QoR Bit 5 = Teach busy Bit 6 ... 15 = measured value
Digital output	Q ₁
Number	1

Ambient data

Ambient operating temperature	+5 °C ... +55 °C ¹⁾
Ambient temperature, storage	-20 °C ... +70 °C
Shock load	According to EN 60068-2-27
EMC	EN 60947-5-2 ²⁾
UL File No.	NRKH.E191603 & NRKH7.E191603

¹⁾ Do not bend below 0 °C.

²⁾ The sensor complies with the Radio Safety Requirements (EMC) for the industrial sector (Radio Safety Class A). It may cause radio interference if used in a residential area.

Connection type/pinouts

Connection type	Cable open end, 4-wire, 2 m
Connection type Detail	
Cable diameter	Ø 3.5 mm
Conductor cross section	0.14 mm ²
Cable material	PVC
Length of cable	2 m
Pinouts	
BN	+ (L+)
WH	MF
BU	- (M)
BK	Q/C

Smart Task

Smart Task name	Base logics
------------------------	-------------

Classifications

ECLASS 5.0	27270909
ECLASS 5.1.4	27270909
ECLASS 6.0	27270909
ECLASS 6.2	27270909
ECLASS 7.0	27270909
ECLASS 8.0	27270909
ECLASS 8.1	27270909
ECLASS 9.0	27270909
ECLASS 10.0	27270909
ECLASS 11.0	27270909
ECLASS 12.0	27270909
ETIM 5.0	EC002720
ETIM 6.0	EC002720
ETIM 7.0	EC002720
ETIM 8.0	EC002720
UNSPSC 16.0901	39121528

Dimensional drawing (Dimensions in mm (inch))

Dimensional drawing, sensor

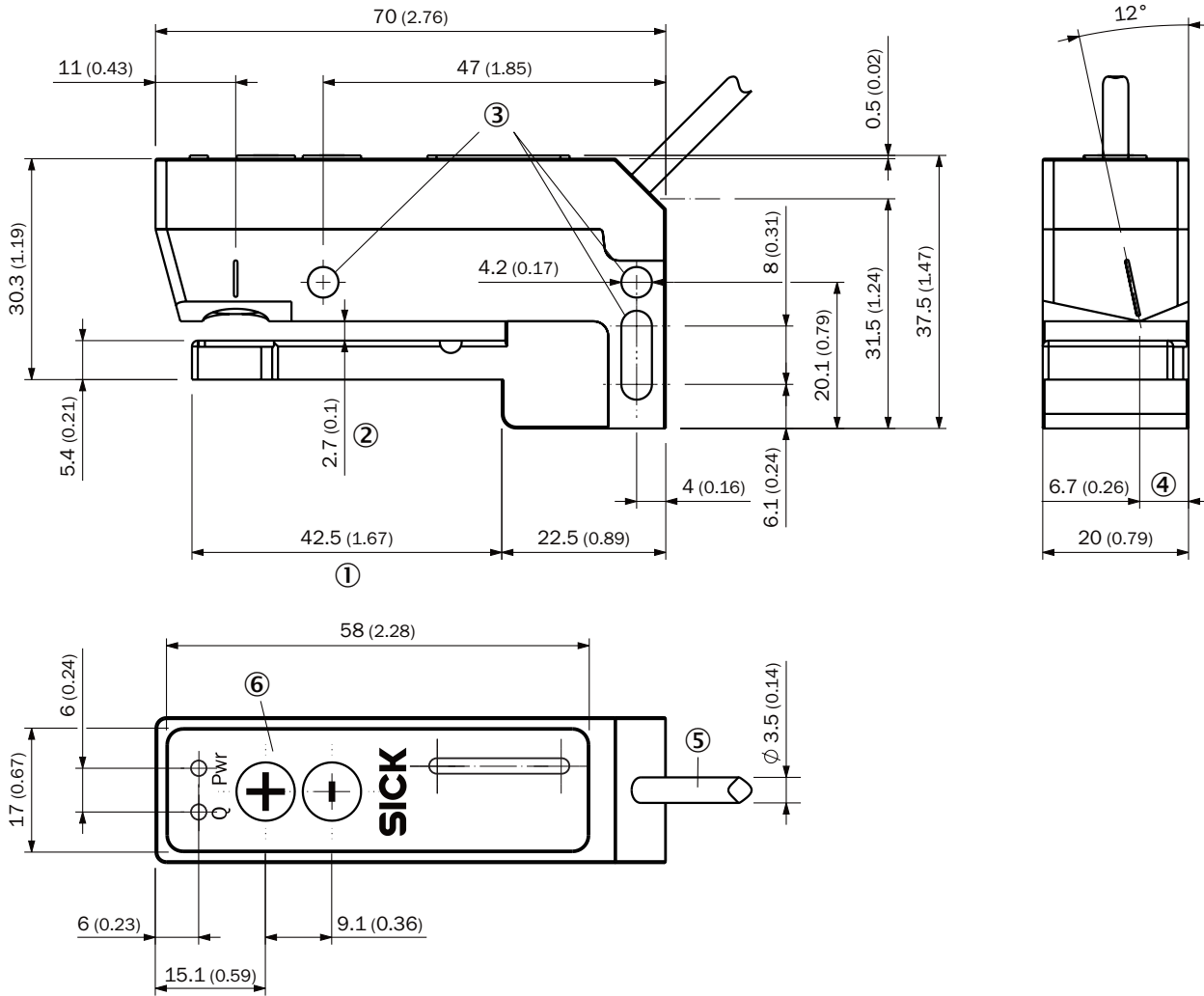

- ① Fork depth
- ② Fork width
- ③ Fixing hole
- ④ Detection axis
- ⑤ Connection (see technical data for length of cable)
- ⑥ Display and adjustment elements

Pinouts

Pinouts, see table Technical data: **Connection type/pinouts**

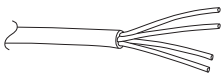

Cable with flying leads, 4-wire, AWG26 0.15 mm²

Adjustments



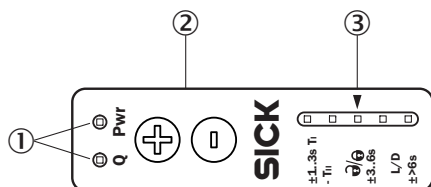

Display and adjustment elements



- ① LEDs (status display)
- ② Teach-in button
- ③ Bar graph

Recommended accessories

Other models and accessories → www.sick.com/UFS

	Brief description	Type	Part no.
Connection modules			
	IO-Link V1.1 Class A port, USB2.0 port, optional external power supply 24V / 1A	IOLA2US-01101 (SiLink2 Master)	1061790
Universal bar clamp systems			
	WFS mounting rod, straight, including 2 x fixing screws, Aluminum	BEF-M12GF-A	2059414
	Bar clamp for bar diameter of 12 mm (fixing the mounting rod), Aluminum, 2 screws M6 x 30, 2 spring discs	BEF-RMC-D12	5321878
	<ul style="list-style-type: none"> • Connection type head A: Male connector, M12, 4-pin, straight, A-coded • Description: Unshielded • Connection systems: Screw-type terminals • Permitted cross-section: ≤ 0.75 mm² 	STE-1204-G	6009932
Sensor Integration Gateway			
	<ul style="list-style-type: none"> • Further functions: Web server integrated, IIoT interface available (dual talk) • Logic editor: no • Communication interface: IO-Link, Ethernet, PROFINET, REST API, MQTT, OPC UA • Product category: IO-Link Master 	SIG350-0004AP100	6076871
	<ul style="list-style-type: none"> • Further functions: Web server integrated, IIoT interface available (dual talk) • Logic editor: no • Communication interface: IO-Link, Ethernet, EtherNet/IP™, REST API, MQTT, OPC UA • Product category: IO-Link Master 	SIG350-0005AP100	6076923
	<ul style="list-style-type: none"> • Further functions: Web server integrated, IIoT interface available (dual talk) • Logic editor: no • Communication interface: IO-Link, Ethernet, EtherCAT®, REST API, MQTT, OPC UA • Product category: IO-Link Master 	SIG350-0006AP100	6076924

SICK AT A GLANCE

SICK is one of the leading manufacturers of intelligent sensors and sensor solutions for industrial applications. A unique range of products and services creates the perfect basis for controlling processes securely and efficiently, protecting individuals from accidents and preventing damage to the environment.

We have extensive experience in a wide range of industries and understand their processes and requirements. With intelligent sensors, we can deliver exactly what our customers need. In application centers in Europe, Asia and North America, system solutions are tested and optimized in accordance with customer specifications. All this makes us a reliable supplier and development partner.

Comprehensive services complete our offering: SICK LifeTime Services provide support throughout the machine life cycle and ensure safety and productivity.

For us, that is “Sensor Intelligence.”

WORLDWIDE PRESENCE:

Contacts and other locations –www.sick.com