



DAXLVN-0400BA080000M01

DAX®

**SICK**  
Sensor Intelligence.



Illustration may differ

### Ordering information

Type	Part no.
DAXLVN-0400BA080000M01	1133524

Mounting brackets and position magnet enclosed. Mounting material for base not included.

Other models and accessories → [www.sick.com/DAX](http://www.sick.com/DAX)



### Detailed technical data

#### Performance

<b>Linearity</b>	≤ 0.03% F.S. (Minimum 90 µm) <sup>1) 2)</sup>	
<b>Repeatability</b>	≤ ± 20 µm	
<b>Measured values</b>	Positioning	
<b>Measuring range</b>	0 mm ... 400 mm	
<b>Unusable range</b>	Null zone	55 mm
	Damping zone	63 mm
<b>Magnet type</b>	Magnet shape	Block magnet
	Number of magnets	1 piece
<b>Magnet travel speed</b>	Any	
<b>Measuring frequency (internal)</b>	< 2 ms	

<sup>1)</sup> Systematic position measurement deviation according to DIN ISO 1319-1 (value includes all systematic errors or deviations from the actual position value, e.g. repeatability and hysteresis).

<sup>2)</sup> In principle, the size of the measurement deviation is limited by the resolution of the interface.

#### Interfaces

<b>Communication interface</b>	Analog	
<b>Communication Interface detail</b>	Voltage	
<b>Output signal</b>	0 V DC ... 10 V DC	
<b>Signals</b>	Number of signals	2 output signals (one output signal + an inverted second output signal)
	Sequence of signals	Signal 1: rising, signal 2: falling

#### Electrical data

<b>Connection type</b>	Male connector, M12, 8-pin
<b>Male connector coding</b>	A-coded
<b>Supply voltage</b>	24 V DC (± 20%)
<b>Reverse polarity protection</b>	Up to -30 V DC

<sup>1)</sup> This product is a standard product and does not constitute a safety component as defined in the Machinery Directive. Calculation based on nominal load of components, average ambient temperature 40°C, frequency of use 8760 h/a. All electronic failures are considered hazardous. For more information, see document no. 8015532.

<b>Residual ripple</b>	≤ 0.28 V <sub>pp</sub>
<b>Dielectric strength</b>	500 V DC, 0 V against housing
<b>Over voltage protection</b>	≤ 36 V DC
<b>MTTFd: mean time to dangerous failure</b>	123 years <sup>1)</sup>

<sup>1)</sup> This product is a standard product and does not constitute a safety component as defined in the Machinery Directive. Calculation based on nominal load of components, average ambient temperature 40 °C, frequency of use 8760 h/a. All electronic failures are considered hazardous. For more information, see document no. 8015532.

## Mechanical data

<b>Mechanical design</b>	DAX® Low Profile
<b>Material</b>	
Housing	Aluminum (anodised), zinc, stainless steel, brass

## Ambient data

<b>EMC</b>	According to EN 61000-6-2 and EN 61000-6-4
<b>Enclosure rating</b>	IP65 / IP67 <sup>1)</sup>
<b>Temperature</b>	
Operating temperature range	-40 °C ... +85 °C
Storage temperature range	-40 °C ... +85 °C
<b>Permissible relative humidity</b>	90 % (Condensation not permitted)
<b>Resistance to shocks</b>	100 g, 6 ms (IEC 60068-2-27)
<b>Resistance to vibration</b>	8 g / 10...2,000 Hz according to IEC 60068-2-6 <sup>2)</sup>

<sup>1)</sup> In correctly assembled mating connector.

<sup>2)</sup> Resonance frequencies can influence signal quality.

## General notes

<b>Items supplied</b>	Mounting brackets and position magnet enclosed. Mounting material for base not included.
-----------------------	--

## Classifications

<b>eCl@ss 5.0</b>	27270705
<b>eCl@ss 5.1.4</b>	27270705
<b>eCl@ss 6.0</b>	27270705
<b>eCl@ss 6.2</b>	27270705
<b>eCl@ss 7.0</b>	27270705
<b>eCl@ss 8.0</b>	27270705
<b>eCl@ss 8.1</b>	27270705
<b>eCl@ss 9.0</b>	27270705
<b>eCl@ss 10.0</b>	27270705
<b>eCl@ss 11.0</b>	27270705
<b>eCl@ss 12.0</b>	27274304
<b>ETIM 5.0</b>	EC002544
<b>ETIM 6.0</b>	EC002544
<b>ETIM 7.0</b>	EC002544
<b>ETIM 8.0</b>	EC002544

UNSPSC 16.0901

41111613

Dimensional drawing (Dimensions in mm (inch))

DAX® Low Profile

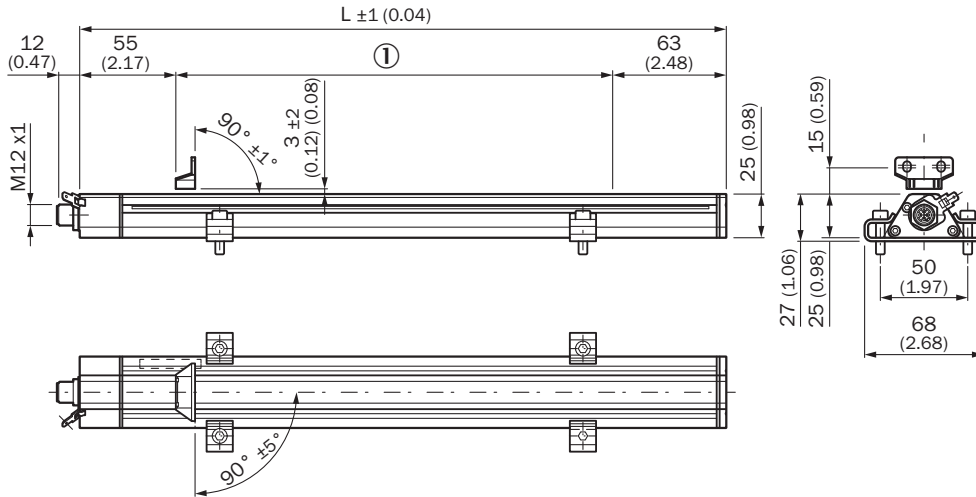

① Measuring range

Distance tolerance

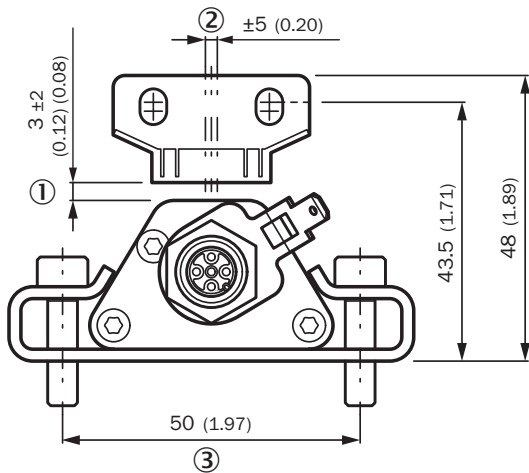

① Nominal distance + permissible amount of distance tolerance

② Permissible center offset

③ Recommendation: M5 x 20

Positioning of mounting bracket

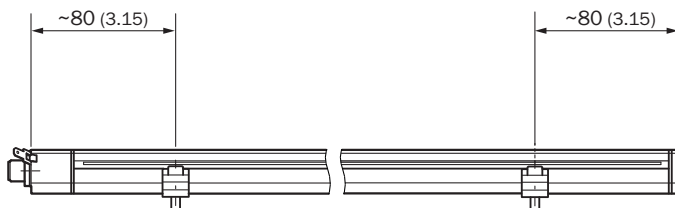

Block magnet

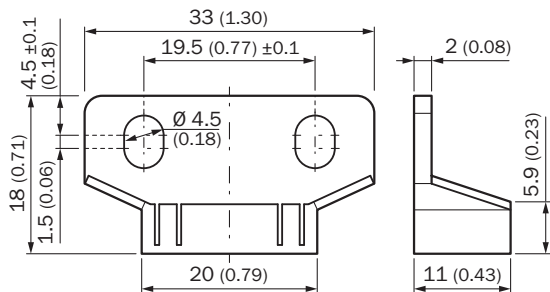

PIN assignment

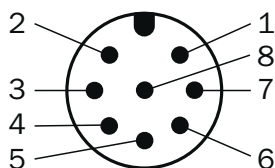

M12 male connector, 8-pin	Signal
1	Output signal ground (0 V PIN 3)
2	Output signal ground (0 V PIN 5)
3	Signal 2
4	n.c.
5	Signal 1
6	Power Ground
7	+24 V DC
8	n.c.

Recommended accessories

Other models and accessories → [www.sick.com/DAX](http://www.sick.com/DAX)

	Brief description	Type	Part no.
<b>Magnets</b>			
	Compact block magnet for magnetostrictive linear encoders	MAG-B-180-01	2129171
<b>Plug connectors and cables</b>			
	Head A: cable Head B: Flying leads Cable: SSI, Incremental, HIPERFACE®, PUR, halogen-free, shielded	LTG-2308-MWENC	6027529
	Head A: cable Head B: Flying leads Cable: SSI, TTL, HTL, Incremental, PUR, halogen-free, shielded	LTG-2612-MW	6028516

	Brief description	Type	Part no.
	Head A: female connector, M12, 8-pin, straight Head B: Flying leads Cable: Incremental, SSI, PUR, halogen-free, shielded, 2 m	DOL-1208-G02MAC1	6032866
	Head A: female connector, M12, 8-pin, straight Head B: Flying leads Cable: Incremental, SSI, PUR, halogen-free, shielded, 5 m	DOL-1208-G05MAC1	6032867
	Head A: female connector, M12, 8-pin, straight Head B: Flying leads Cable: Incremental, SSI, PUR, halogen-free, shielded, 10 m	DOL-1208-G10MAC1	6032868
	Head A: female connector, M12, 8-pin, straight Head B: Flying leads Cable: Incremental, SSI, PUR, halogen-free, shielded, 20 m	DOL-1208-G20MAC1	6032869
	Head A: female connector, M12, 8-pin, straight Head B: Flying leads Cable: Incremental, SSI, PUR, halogen-free, shielded, 25 m	DOL-1208-G25MAC1	6067859
	Head A: female connector, M12, 8-pin, straight, A-coded Cable: Incremental, SSI, shielded	DOS-1208-GA01	6045001
<b>Terminal and alignment brackets</b>			
	Replacement clamping bracket for DAX® Low Profile without fastening material, 2 pieces	BEF-KH-LP1-02	2125244
	Replacement clamping bracket for DAX® Low Profile without fastening material, 3 pieces	BEF-KH-LP1-03	2125245
	Replacement clamping bracket for DAX® Low Profile without fastening material, 4 pieces	BEF-KH-LP1-04	2125246

## SICK AT A GLANCE

SICK is one of the leading manufacturers of intelligent sensors and sensor solutions for industrial applications. A unique range of products and services creates the perfect basis for controlling processes securely and efficiently, protecting individuals from accidents and preventing damage to the environment.

We have extensive experience in a wide range of industries and understand their processes and requirements. With intelligent sensors, we can deliver exactly what our customers need. In application centers in Europe, Asia and North America, system solutions are tested and optimized in accordance with customer specifications. All this makes us a reliable supplier and development partner.

Comprehensive services complete our offering: SICK LifeTime Services provide support throughout the machine life cycle and ensure safety and productivity.

For us, that is “Sensor Intelligence.”

## WORLDWIDE PRESENCE:

Contacts and other locations –[www.sick.com](http://www.sick.com)