



RFH620-1001201

RFH6xx

RFID

SICK
Sensor Intelligence.



Ordering information

Type	Part no.
RFH620-1001201	1044839

Other models and accessories → www.sick.com/RFH6xx



Detailed technical data

Features

Version	Short Range
Product category	RFID read/write device with integrated antenna
Radio approval	Global
Frequency band	HF (13.56 MHz)
Carrier frequency	13.56 MHz
Output power	200 mW
RFID standard	ISO/IEC 15693, ISO/IEC 18000-3 "Mode 1"
Connection type	Ethernet
Read range	≤ 150 mm ¹⁾
Antenna	Integrated
Transmitting power	200 mW
Typical access times	UID read (64 bits/8 bytes): 18 ms Read 1 block (32 bit/4 Byte): 13 ms Write 1 block (32 bit/4 Byte): 16 ms Read 28 blocks (896 bit/112 Byte): 64 ms Write 28 blocks (896 bit/112 Byte): 442 ms
Air interface data transmission rate	26 kbit/s (default)

¹⁾ With RFID ISO card transponder in plane parallel alignment to read/write device antenna; depending on dimensions and quality of transponder.

Mechanics/electronics

Connection type	1 x M12, 12-pin male connector, A-coded 1 x M12, 4-pin female connector, D-coded
Supply voltage	10 V DC ... 30 V DC
Power consumption	Typ. 5 W

¹⁾ Swivel connector is 15 mm longer.

Housing	Aluminum die cast Plastic (PPS)
Housing color	Blue, black
Enclosure rating	IP67
Protection class	III
Weight	450 g
Dimensions (L x W x H)	147 mm x 88 mm x 39 mm ¹⁾
MTBF	> 100 years

¹⁾ Swivel connector is 15 mm longer.

Interfaces

Ethernet	✓, TCP/IP
Function	Host, AUX
Data transmission rate	10/100 MBit/s
PROFINET	✓
Function	PROFINET Single Port, PROFINET Dual Port (optional via external connection module CDF600-2), Host
Data transmission rate	10/100 MBit/s
EtherNet/IP™	✓
Function	Host
Data transmission rate	10/100 MBit/s
EtherCAT	✓
Type of fieldbus integration	Optional over external fieldbus module CDF600
Function	Host
Serial	✓, RS-232, RS-422, RS-485
Remark	RS-422/RS-485 only via 4-wire
Function	Host, AUX
Data transmission rate	0.3 kBaud ... 115.2 kBaud, AUX: 57.6 kBaud
CAN	✓
Remark	CSN (SICK CAN Sensor Network)
Function	Host
Data transmission rate	20 kbit/s ... 1,000 kbit/s
CANopen	✓
Function	Host
Data transmission rate	20 kbit/s ... 1,000 kbit/s
PROFIBUS DP	✓
Type of fieldbus integration	Optional over external fieldbus module CDF600-2
Function	Host
Digital inputs	1 (physical, 2 additional logical inputs via optional CMC600 parameter memory in CD-B620 / CDM420)
Digital outputs	2 additional logical outputs via optional CMC600 parameter memory in CDB620 / CDM420
Optical indicators	6 LEDs, multi-color (device status)
Acoustic indicators	1 beeper (Feedback)

¹⁾ Another alternative is to generate your own configuration tools based on the SICK command language CoLa (e.g. in your own software or on PLC function blocks).

Configuration software	SOPAS ET ¹⁾
Memory card	microSD memory card (parameter cloning)

¹⁾ Another alternative is to generate your own configuration tools based on the SICK command language CoLa (e.g. in your own software or on PLC function blocks).

Ambient data

Electromagnetic compatibility (EMC)	EN 301489-3
Vibration resistance	EN 60068-2-64:2008-02
Shock resistance	EN 60068-2-27:2009-05
Ambient operating temperature	-20 °C ... +60 °C
Storage temperature	-25 °C ... +70 °C
Permissible relative humidity	95 %, Non-condensing

Classifications

eCl@ss 5.0	27280401
eCl@ss 5.1.4	27280401
eCl@ss 6.0	27280401
eCl@ss 6.2	27280401
eCl@ss 7.0	27280401
eCl@ss 8.0	27280401
eCl@ss 8.1	27280401
eCl@ss 9.0	27280401
eCl@ss 10.0	27280401
eCl@ss 11.0	27280401
eCl@ss 12.0	27280401
ETIM 6.0	EC002998
ETIM 7.0	EC002998
ETIM 8.0	EC002998
UNSPSC 16.0901	52161523

Dimensional drawing (Dimensions in mm (inch))

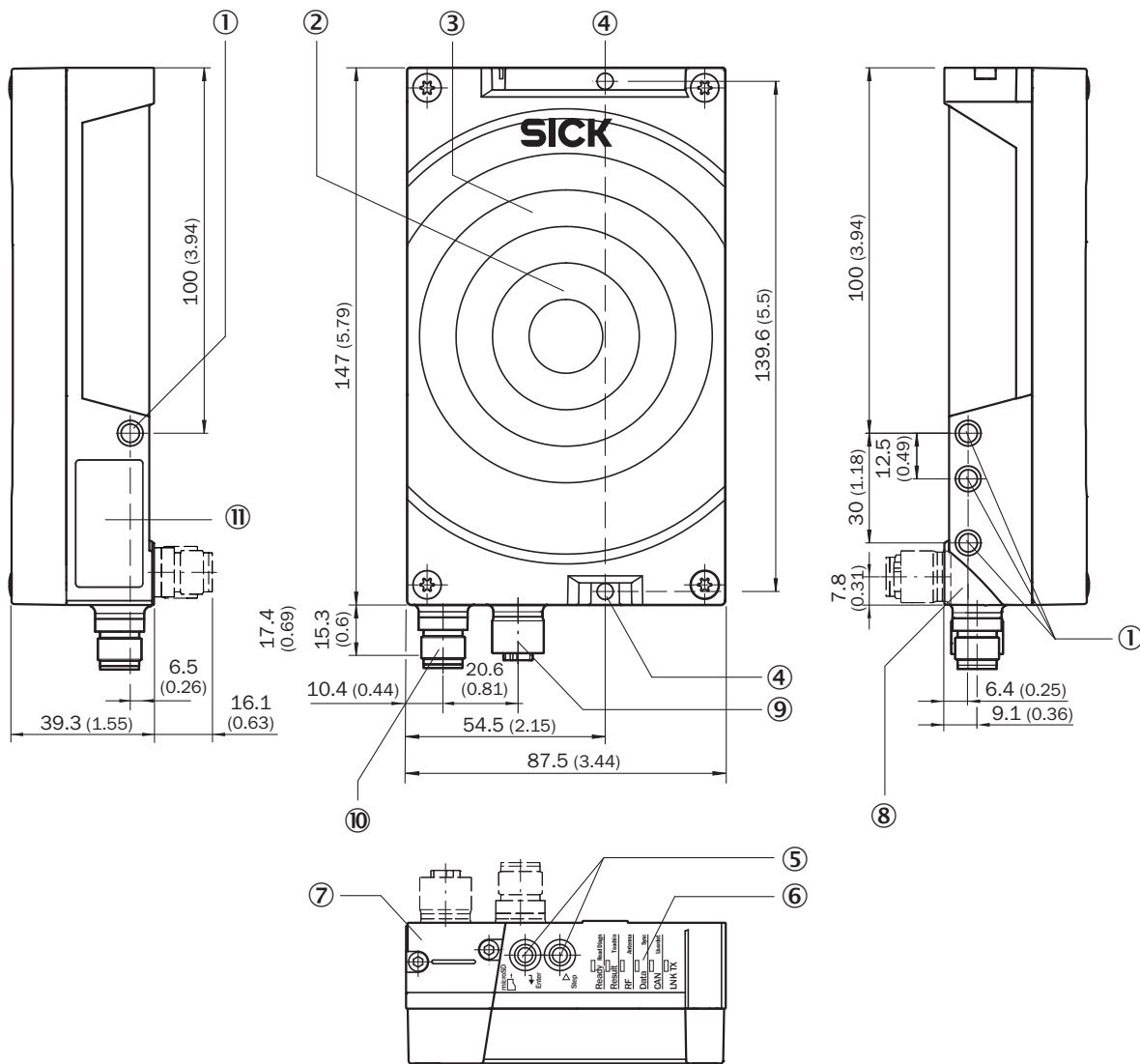

- ① 4 x M6 blind tapped holes, 6.5 mm deep for mounting the device
- ② Cover with integrated antenna
- ③ Position of the beeper under the antenna cover
- ④ 2 x mounting hole \varnothing 4.5 mm, for alternative mounting of the device
- ⑤ Function button (2 x)
- ⑥ 6 x RGB LED, multi-colored (status indicators)
- ⑦ Slot for microSD memory card
- ⑧ Swivel connector unit
- ⑨ "Ethernet" connection, 4-pin M12 female connector, D-coded
- ⑩ "Power/Serial Data/CAN/I/O" connection, 12-pin M12 male connector, A-coded
- ⑪ Type label

Reading field diagram

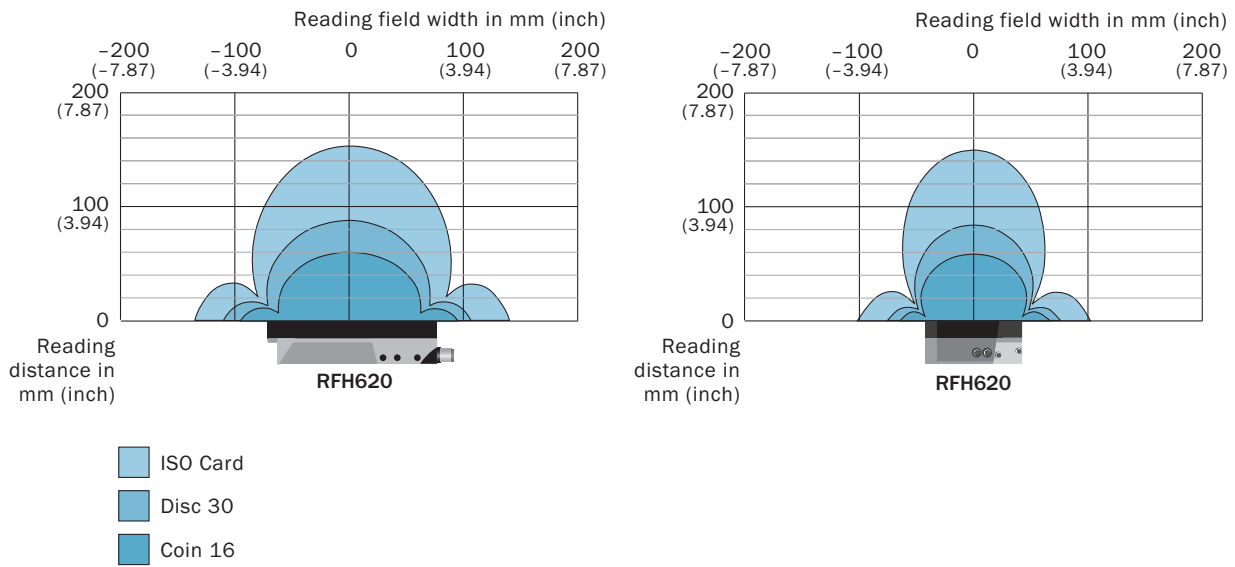

Assembly note

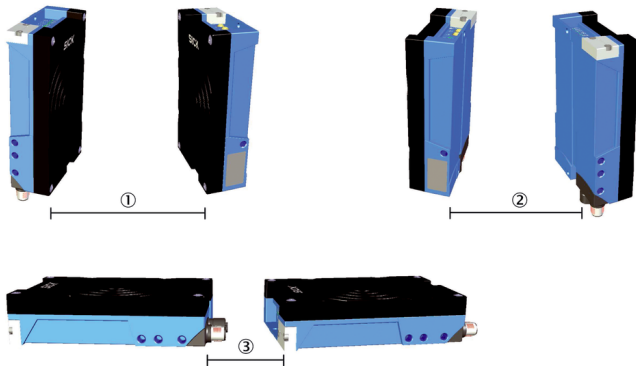

Distances required to prevent mutual interference with mounting of two devices.

Product type	1	2	3
RFH620 Short Range	340 mm	140 mm	150 mm
RFH630 Mid Range	1,700 mm	1,200 mm	1,300 mm

Connection diagram

PROFINET IO/RT

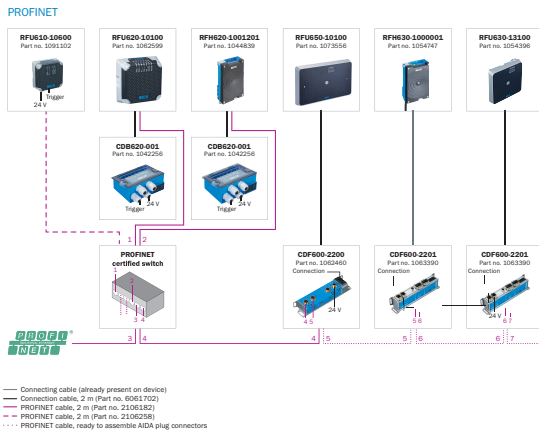



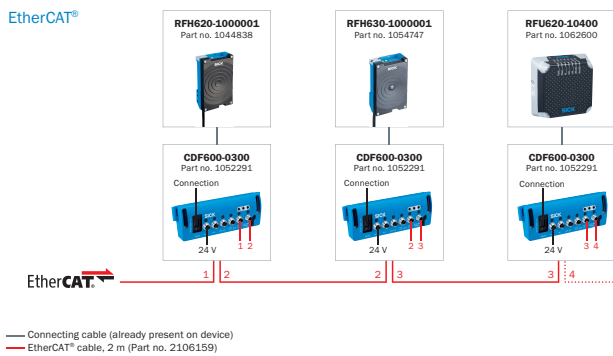

EtherCAT®



Recommended accessories

Other models and accessories → www.sick.com/RFH6xx

	Brief description	Type	Part no.
Mounting brackets and plates			
	Mounting bracket, mounting hardware included	Mounting bracket	2048551
Plug connectors and cables			
	Head A: male connector, M12, 4-pin, straight, D-coded Head B: male connector, RJ45, 4-pin, straight Cable: Ethernet, PROFINET, PUR, halogen-free, shielded, 2 m	YM2D24-020PN1MRJA4	2106182

	Brief description	Type	Part no.
Others			
	<ul style="list-style-type: none"> • Carrier frequency: 13.56 MHz • Memory capacity (UII / user memory): 896 Bit (28 x 4 Byte) • Dimensions (L x W x H): 49 mm x 81 mm x 0.42 mm 	HF transponder, paper label	6037763
Modules			
	<ul style="list-style-type: none"> • Sub product family: CDB620 • Supported products: CLV61x - CLV65x, Lector62x, RFH6xx, RFU62x • Brief description: Small connection module for one sensor, 4 cable glands, base for CMC600 	CDB620-001	1042256

Recommended services

Additional services → www.sick.com/RFH6xx

	Type	Part no.
Maintenance		
<ul style="list-style-type: none"> • Product area: RFID • Range of services: Inspection, analysis and restoring of defined functions, Checking and adjustment of reading configuration, data processing, network, interfaces and inputs and outputs as well as operating data • Duration: Additional work will be invoiced separately • Travel expenses: The prices do not include travel costs such as hotel, flight, travel time and expenses. 	Maintenance RFU/RFH	1611424
Commissioning		
<ul style="list-style-type: none"> • Product area: RFID • Range of services: Inspection of connection, alignment, optimization of parameters of the RFU/RFH as well as tests, Setup of previously defined functions of reading configuration, data processing and network, interfaces and inputs and outputs • Travel expenses: The prices do not include travel costs such as hotel, flight, travel time and expenses. • Duration: Additional work will be invoiced separately 	Commissioning RFU/RFH	1610018
Extended warranty		
<ul style="list-style-type: none"> • Product area: Identification solutions, machine vision, Distance sensors, Detection and ranging solutions • Range of services: The services correspond to the scope of the statutory manufacturer warranty (SICK general terms of delivery). • Duration: Five-year warranty from delivery date. 	Extended warranty for a total of five years from delivery date	1680671

SICK AT A GLANCE

SICK is one of the leading manufacturers of intelligent sensors and sensor solutions for industrial applications. A unique range of products and services creates the perfect basis for controlling processes securely and efficiently, protecting individuals from accidents and preventing damage to the environment.

We have extensive experience in a wide range of industries and understand their processes and requirements. With intelligent sensors, we can deliver exactly what our customers need. In application centers in Europe, Asia and North America, system solutions are tested and optimized in accordance with customer specifications. All this makes us a reliable supplier and development partner.

Comprehensive services complete our offering: SICK LifeTime Services provide support throughout the machine life cycle and ensure safety and productivity.

For us, that is “Sensor Intelligence.”

WORLDWIDE PRESENCE:

Contacts and other locations –www.sick.com