



# GTB6L-P4211

G6

MINIATURE PHOTOELECTRIC SENSORS

**SICK**  
Sensor Intelligence.



Illustration may differ



### Ordering information

Type	Part no.
GTB6L-P4211	1105810

Other models and accessories → [www.sick.com/G6](http://www.sick.com/G6)

### Detailed technical data

#### Features

<b>Functional principle</b>	Photoelectric proximity sensor
<b>Functional principle detail</b>	Background suppression
<b>Sensing range</b>	
Sensing range min.	10 mm
Sensing range max.	400 mm
Adjustable switching threshold for background suppression	30 mm ... 400 mm
Reference object	Object with 90% remission factor (complies with standard white according to DIN 5033)
Minimum distance between set sensing range and background (black 6% / white 90%)	3 mm, at a distance of 75 mm
Recommended sensing range for the best performance	30 mm ... 180 mm
<b>Polarisation filters</b>	No
<b>Emitted beam</b>	
Light source	Laser
Type of light	Visible red light
Shape of light spot	Point-shaped
Light spot size (distance)	Ø 0.4 mm (150 mm)
Maximum dispersion of the emitted beam around the standardized transmission axis (squint angle)	< +/- 1.5° (at T <sub>a</sub> = +23 °C)
<b>Key laser figures</b>	
Normative reference	IEC 60825-1 / CDRH 21 CFR 1040.10 & 1040.11
Laser class	1
Wave length	680 nm
Pulse duration	2 µs
Maximum pulse power	< 5.94 mW
Average service life	100,000 h at T <sub>a</sub> = +25 °C

<b>Smallest detectable object (MDO) typ.</b>		0.4 mm (at 150 mm distance (object with 90% remission (corresponds to standard white DIN 5033)))
<b>Adjustment</b>	Potentiometer	For setting the sensing range, 5 rotations
	Operating mode switch	For inverting the switching function (light/dark switching)
<b>Indication</b>	LED green	Operating indicator Static on: power on
	LED yellow	Status of received light beam Static on: object present Static off: object not present

### Safety-related parameters

<b>MTTF<sub>D</sub></b>	662 years
<b>DC<sub>avg</sub></b>	0 %
<b>T<sub>M</sub> (mission time)</b>	10 years (EN 60825-1)

### Electrical data

<b>Supply voltage U<sub>B</sub></b>	10 V DC ... 30 V DC <sup>1)</sup>	
<b>Ripple</b>	< 5 V <sub>pp</sub>	
<b>Usage category</b>	DC-13 (According to EN 60947-5-2)	
<b>Current consumption</b>	≤ 20 mA, without load. At U <sub>B</sub> = 24 V	
<b>Protection class</b>	III	
<b>Digital output</b>	Number	1
	Type	PNP
	Signal voltage PNP HIGH/LOW	Approx. U <sub>B</sub> -3 V / 0 V
	Output current I <sub>max.</sub>	≤ 100 mA <sup>2)</sup>
	Circuit protection outputs	Reverse polarity protected Overcurrent protected Short-circuit protected
	Response time	≤ 625 μs
Switching frequency	1,000 Hz <sup>3)</sup>	
<b>Pin/Wire assignment</b>	Function of pin 4/black (BK)	Digital output, light switching, object present → output Q HIGH
	Function of pin 4/black (BK) – detail	The pin 4 function of the sensor can be switched, Additional possible settings via operating mode switch

<sup>1)</sup> Limit values U<sub>B</sub> connections, reverse polarity protected.

<sup>2)</sup> At U<sub>B</sub> > 24 V, I max. = 50 mA.

<sup>3)</sup> With light/dark ratio 1:1.

### Mechanical data

<b>Housing</b>	Rectangular
<b>Dimensions (W x H x D)</b>	12 mm x 31.5 mm x 21 mm
<b>Connection</b>	Male connector M8, 4-pin
<b>Material</b>	

Housing	Plastic, ABS
Front screen	Plastic, PMMA
Cable	PVC
Male connector	Copper alloy (C3604 CUZN39PB3)
<b>Weight</b>	Approx. 60 g

**Ambient data**

<b>Enclosure rating</b>	IP67 (EN 60529)
<b>Ambient operating temperature</b>	-20 °C ... +50 °C <sup>1) 2)</sup>
<b>Ambient temperature, storage</b>	-40 °C ... +70 °C
<b>Typ. Ambient light immunity</b>	Sunlight: ≤ 13,000 lx
<b>Shock resistance</b>	30 g, 11 ms (3 positive and 3 negative shocks along X, Y, Z axes, 18 total shocks (EN60068-2-27))
<b>Vibration resistance</b>	10 Hz ... 55 Hz (Amplitude 0.5 mm, 3x30 min (EN60068-2-6))
<b>Air humidity</b>	35 % ... 95 %, Relative humidity (no condensation)
<b>Electromagnetic compatibility (EMC)</b>	EN 60947-5-2
<b>UL File No.</b>	NRKH.E348498 & NRKH7.E348498

<sup>1)</sup> As of  $T_a \Rightarrow 45 \text{ °C}$ , a max. supply voltage  $U_B = 24 \text{ V}$  and a max. load current  $I_{max.} = 50 \text{ mA}$  is permitted.

<sup>2)</sup> Below  $T_a = -20 \text{ °C}$  a warm-up time of 3 seconds is required.

**Classifications**

<b>eCl@ss 5.0</b>	27270904
<b>eCl@ss 5.1.4</b>	27270904
<b>eCl@ss 6.0</b>	27270904
<b>eCl@ss 6.2</b>	27270904
<b>eCl@ss 7.0</b>	27270904
<b>eCl@ss 8.0</b>	27270904
<b>eCl@ss 8.1</b>	27270904
<b>eCl@ss 9.0</b>	27270904
<b>eCl@ss 10.0</b>	27270904
<b>eCl@ss 11.0</b>	27270904
<b>eCl@ss 12.0</b>	27270903
<b>ETIM 5.0</b>	EC002719
<b>ETIM 6.0</b>	EC002719
<b>ETIM 7.0</b>	EC002719
<b>ETIM 8.0</b>	EC002719
<b>UNSPSC 16.0901</b>	39121528

Connection type

Male connector M8, 4-pin

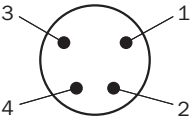

Connection diagram

Cd-066

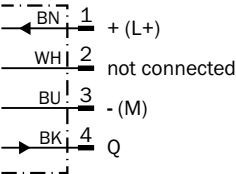

Truth table

PNP - light switching

	Light switching Q (normally open)	
	Object not present → Output LOW	Object present → Output HIGH
Light receive	✗	✔
Light receive indicator	✗	☀
Load resistance	✗	⚠

PNP - dark switching

	Dark switching $\bar{Q}$ (normally closed)	
	Object not present → Output HIGH	Object present → Output LOW
Light receive	✗	✔
Light receive indicator	✗	☀
Load resistance	⚠	✗

## Characteristic curve

Minimum distance in mm (y) between the set sensing range (x) and white background (90% remission)

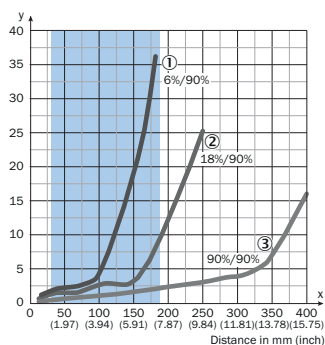

Recommended sensing range for the best performance

- ① Black object, 6% remission factor
- ② Gray object, 18% remission factor
- ③ White object, 90% remission factor

Example:  
Safe suppression of the background

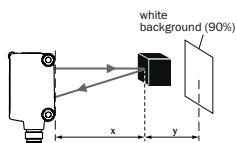

Black object (6% remission)  
Set sensing range  $x = 150$  mm. Needed minimum distance to white background  $y = 20$  mm.

## Light spot size

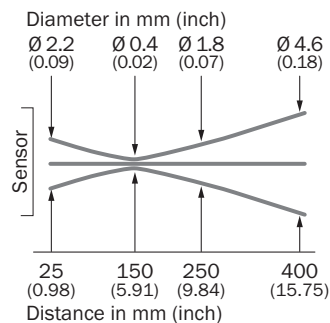

Sensing range diagram

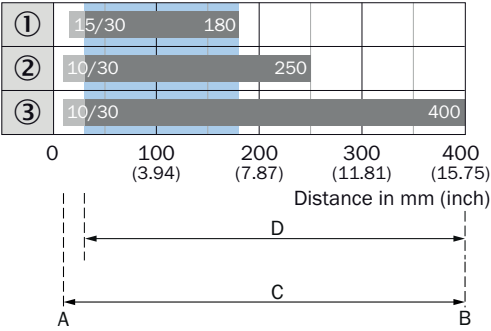

A = Sensing range min. in mm  
 B = Sensing range max. in mm  
 C = Viewing range  
 D = Adjustable switching threshold for background suppression

Recommended sensing range for the best performance

- ① Black object, 6% remission factor
- ② Gray object, 18% remission factor
- ③ White object, 90% remission factor

Adjustments

Display and adjustment elements

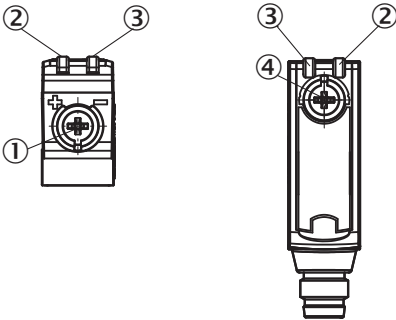

- ① Potentiometer
- ② LED yellow
- ③ LED green
- ④ Operating mode switch

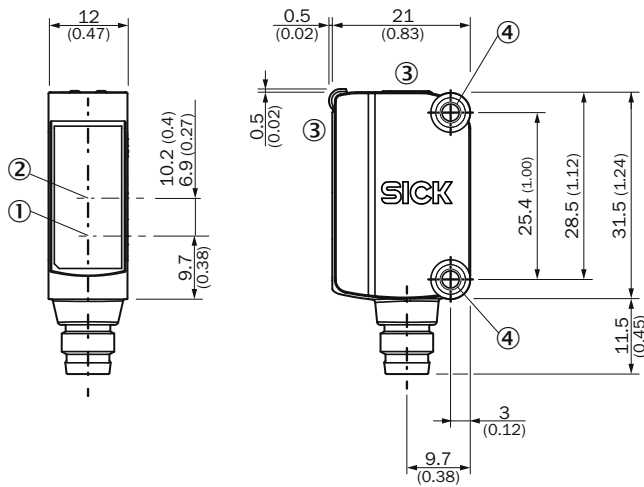

### Dimensional drawing (Dimensions in mm (inch))



- ① Center of optical axis, sender
- ② Center of optical axis, receiver
- ③ Display and adjustment elements
- ④ Mounting holes M3

### Recommended accessories

Other models and accessories → [www.sick.com/G6](http://www.sick.com/G6)

	Brief description	Type	Part no.
Universal bar clamp systems			
	Clamp bar to fix G6 sensors on rods of 12 mm, clamp-on design up to 4 mm wall thickness, aluminum (clamp bar), stainless steel (bracket), clamp bar mounting and clamp function, mounting bracket, mounting hardware	BEF-KHS-IS12G6	2086865
Mounting brackets and plates			
	Stainless steel (1.4301)	BEF-WN-G6	2062909

## SICK AT A GLANCE

SICK is one of the leading manufacturers of intelligent sensors and sensor solutions for industrial applications. A unique range of products and services creates the perfect basis for controlling processes securely and efficiently, protecting individuals from accidents and preventing damage to the environment.

We have extensive experience in a wide range of industries and understand their processes and requirements. With intelligent sensors, we can deliver exactly what our customers need. In application centers in Europe, Asia and North America, system solutions are tested and optimized in accordance with customer specifications. All this makes us a reliable supplier and development partner.

Comprehensive services complete our offering: SICK LifeTime Services provide support throughout the machine life cycle and ensure safety and productivity.

For us, that is “Sensor Intelligence.”

## WORLDWIDE PRESENCE:

Contacts and other locations –[www.sick.com](http://www.sick.com)