



WS/WE100-2P1239S01

W100-2

MINIATURE PHOTOELECTRIC SENSORS

SICK
Sensor Intelligence.



Ordering information

Type	Part no.
WS/WE100-2P1239S01	6052401

Included in delivery: BEF-W100-A (2)

Other models and accessories → www.sick.com/W100-2

Illustration may differ



Detailed technical data

Features

Sensor/ detection principle	Through-beam photoelectric sensor
Dimensions (W x H x D)	11 mm x 31 mm x 20 mm
Housing design (light emission)	Rectangular
Sensing range max.	0 m ... 33 m
Sensing range	0 m ... 20 m
Type of light	Visible red light
Light source	LED ¹⁾
Light spot size (distance)	Ø 850 mm (12 m)
Wave length	632 nm
Adjustment	None

¹⁾ Average service life: 100,000 h at T_U = +25 °C.

Mechanics/electronics

Supply voltage	10 V DC ... 30 V DC ¹⁾
Ripple	± 10 % ²⁾
Power consumption, sender	≤ 15 mA ³⁾
Power consumption, receiver	≤ 20 mA ³⁾

¹⁾ Limit values.

²⁾ May not exceed or fall below U_V tolerances.

³⁾ Without load.

⁴⁾ Signal transit time with resistive load.

⁵⁾ With light/dark ratio 1:1.

⁶⁾ Do not bend below 0 °C.

⁷⁾ A = V_S connections reverse-polarity protected.

⁸⁾ B = output reverse-polarity protected.

⁹⁾ D = outputs overcurrent and short-circuit protected.

Switching output	PNP
Switching mode	Dark switching
Signal voltage PNP HIGH/LOW	$U_V - 1,8 \text{ V} / \text{ca. } 0 \text{ V}$
Output current I_{max}	$\leq 100 \text{ mA}$
Response time	$\leq 0,5 \text{ ms}^{4)}$
Switching frequency	$1,000 \text{ Hz}^{5)}$
Connection type	Cable, 3-wire, 5 m ⁶⁾
Cable material	PVC
Conductor cross-section	0.18 mm ²
Circuit protection	A ⁷⁾ B ⁸⁾ D ⁹⁾
Protection class	III
Housing material	Plastic, ABS/PC/POM
Optics material	Plastic, PMMA
Enclosure rating	IP67
Items supplied	2 Stainless steel mounting brackets (1.4301/304) BEF-W100-A
Ambient operating temperature	-25 °C ... +55 °C
Ambient temperature, storage	-40 °C ... +70 °C

- 1) Limit values.
- 2) May not exceed or fall below U_V tolerances.
- 3) Without load.
- 4) Signal transit time with resistive load.
- 5) With light/dark ratio 1:1.
- 6) Do not bend below 0 °C.
- 7) A = V_S connections reverse-polarity protected.
- 8) B = output reverse-polarity protected.
- 9) D = outputs overcurrent and short-circuit protected.

Classifications

ECl@ss 5.0	27270901
ECl@ss 5.1.4	27270901
ECl@ss 6.0	27270901
ECl@ss 6.2	27270901
ECl@ss 7.0	27270901
ECl@ss 8.0	27270901
ECl@ss 8.1	27270901
ECl@ss 9.0	27270901
ECl@ss 10.0	27270901
ECl@ss 11.0	27270901
ETIM 5.0	EC002716
ETIM 6.0	EC002716
ETIM 7.0	EC002716
UNSPSC 16.0901	39121528

Connection diagram

Cd-049

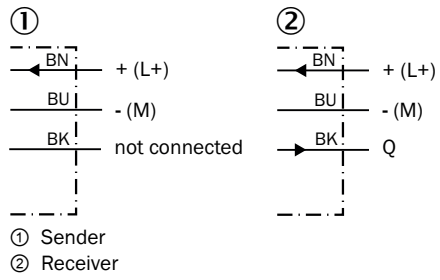

Characteristic curve

WS/WE100-2

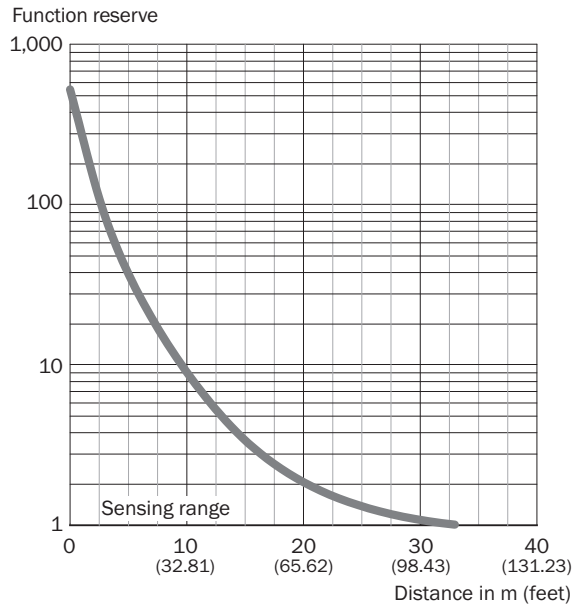

Light spot size

Light spot size

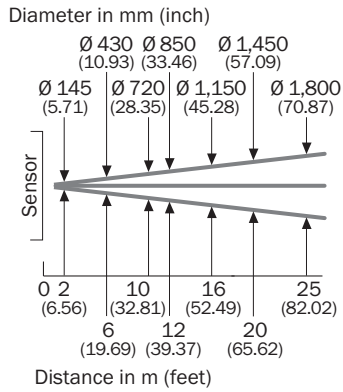

Sensing range diagram

WS/WE100-2

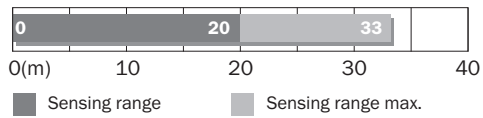

Adjustments

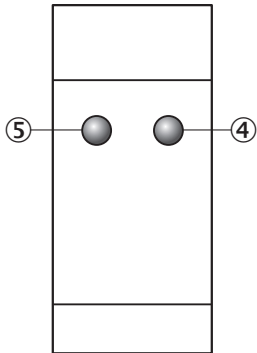

- ④ Orange LED indicator : switching output active
- ⑤ LED indicator green: stability indicator

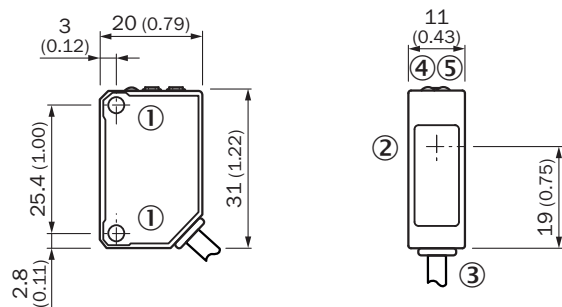

Dimensional drawing (Dimensions in mm (inch))



- ① Threaded mounting hole M3
- ② Center of optical axis, sender (WS), Center of optical axis, receiver (WE)
- ③ Connection
- ④ LED indicator orange: switching output active
- ⑤ LED indicator green: power on

Recommended accessories

Other models and accessories → www.sick.com/W100-2

	Brief description	Type	Part no.
Mounting brackets and plates			
	Mounting bracket for wall mounting, stainless steel, mounting hardware included	BEF-W100-A	5311520
	Mounting bracket for floor mounting, steel, zinc coated, mounting hardware included	BEF-W100-B	5311521
Plug connectors and cables			
	Head A: male connector, M8, 3-pin, straight Head B: - Cable: unshielded	STE-0803-G	6037322

SICK AT A GLANCE

SICK is one of the leading manufacturers of intelligent sensors and sensor solutions for industrial applications. A unique range of products and services creates the perfect basis for controlling processes securely and efficiently, protecting individuals from accidents and preventing damage to the environment.

We have extensive experience in a wide range of industries and understand their processes and requirements. With intelligent sensors, we can deliver exactly what our customers need. In application centers in Europe, Asia and North America, system solutions are tested and optimized in accordance with customer specifications. All this makes us a reliable supplier and development partner.

Comprehensive services complete our offering: SICK LifeTime Services provide support throughout the machine life cycle and ensure safety and productivity.

For us, that is “Sensor Intelligence.”

WORLDWIDE PRESENCE:

Contacts and other locations –www.sick.com