



# PBT-CP015SN1SS0VMC0Z

PBT

PRESSURE TRANSMITTER

**SICK**  
Sensor Intelligence.



Illustration may differ



### Ordering information

Type	Part no.
PBT-CP015SN1SS0VMCOZ	6049103

Other models and accessories → [www.sick.com/PBT](http://www.sick.com/PBT)

### Detailed technical data

#### Features

<b>Medium</b>	Liquid, gaseous
<b>Pressure type</b>	Compound pressure
<b>Pressure unit</b>	psi
<b>Measuring range</b>	-30 inHg ... 0 psi
<b>Process temperature</b>	0 °C ... +80 °C
<b>Maximum ohmic load <math>R_A</math></b>	4 mA ... 20 mA, 2-wire ( $R_A \leq (L^+ - 8 V) / 0.02 A$ [Ohm]) 0 V ... 10 V, 3-wire ( $R_A > 10 k\Omega$ ) 0 V ... 5 V, 3-wire ( $R_A > 5 k\Omega$ )
<b>Output signal</b>	0 V ... 10 V, 3-wire
<b>Specialty</b>	Without

#### Mechanics/electronics

<b>Process connection</b>	¼" NPT
<b>Wetted parts</b>	Pressure Connection: stainless steel 316L Pressure sensor: stainless steel 316L (for measurement ranges from 0 bar ... 10 bar rel stainless steel 13-8 PH)
<b>Internal transmission fluid</b>	Silicone oil (only with pressure ranges < 0 bar ... 10 bar and ≤ 0 bar abs ... 25 bar abs)
<b>Pressure port</b>	Standard
<b>Housing material</b>	Stainless steel
<b>Connection type</b>	M12 round connector x 1, 4-pin
<b>Supply voltage</b>	14 V DC ... 30 V DC <sup>1)</sup>
<b>Power consumption</b>	Signal current (max. 25 mA) for current output Max. 8 mA for voltage output signal
<b>Electrical safety</b>	Overvoltage protection: 32 V DC, 36 V DC with 4 mA ... 20 mA Short-circuit protection: $Q_A$ towards M Reverse polarity protection: $L^+$ to M Protection class: III
<b>Isolation voltage</b>	500 V DC

<sup>1)</sup> The pressure transmitter must be supplied with power by a limited energy circuit compliant with 9.3 of UL/EN/IEC 601010-1 or LPS to UL/EN/IEC 60950-1 or Class 2 to UL 1310/UL1585 (NEC or CEC). The power supply must be suitable for operation above 2,000 m if the pressure transmitter is used above this altitude.

<sup>2)</sup> Enclosure rating IP per IEC 60529. The enclosure rating classes specified only apply when connected with female connectors that provide the corresponding enclosure rating.

<b>CE-conformity</b>	Pressure equipment directive: 2014/68/EU, EMC directive: 2014/30/EU, EN 61 326-2-3
<b>Weight sensor</b>	Approx. 80 g
<b>Seal</b>	Without seal
<b>Enclosure rating</b>	IP67 <sup>2)</sup>
<b>Protection class III</b>	✓
<b>Reference conditions</b>	Reference conditions: According to IEC 61298-1
<b>MTTF</b>	1,176 years

<sup>1)</sup> The pressure transmitter must be supplied with power by a limited energy circuit compliant with 9.3 of UL/EN/IEC 601010-1 or LPS to UL/EN/IEC 60950-1 or Class 2 to UL 1310/UL1585 (NEC or CEC). The power supply must be suitable for operation above 2,000 m if the pressure transmitter is used above this altitude.

<sup>2)</sup> Enclosure rating IP per IEC 60529. The enclosure rating classes specified only apply when connected with female connectors that provide the corresponding enclosure rating.

## Performance

<b>Non-linearity</b>	≤ ± 0.5 %, (Best Fit Straight Line, BFSL) according to IEC 61298-2
<b>Accuracy</b>	≤ ± 1 % of the span
<b>Adjustment accuracy of zero signal</b>	≤ 0.5 % of span typ., ≤ 0.8 % of span max. (with non-linearity 0.5 %)
<b>Hysteresis</b>	≤ 0.16 % of the span
<b>Non-repeatability</b>	≤ 0.1 % of the span
<b>Response time</b>	< 4 ms
<b>Signal noise</b>	≤ 0.3 % of the span
<b>Long-term drift/one-year stability</b>	≤ 0.1 % of span to IEC 61298-2
<b>Rated temperature range</b>	0 °C ... +80 °C
<b>Service life</b>	Minimum 100 Mio. load cycles

## Ambient data

<b>Ambient temperature</b>	0 °C ... +80 °C
<b>Storage temperature</b>	-40 °C ... +70 °C
<b>Relative humidity</b>	45 % ... 75 %
<b>Shock load</b>	500 g according to IEC 60068-2-27 (mechanical shock)
<b>Vibration load</b>	10 g according to IEC 60068-2-6 (vibration under resonance) 20 g optional

## Classifications

<b>eCl@ss 5.0</b>	27200614
<b>eCl@ss 5.1.4</b>	27200614
<b>eCl@ss 6.0</b>	27200614
<b>eCl@ss 6.2</b>	27200614
<b>eCl@ss 7.0</b>	27200614
<b>eCl@ss 8.0</b>	27200614
<b>eCl@ss 8.1</b>	27200614
<b>eCl@ss 9.0</b>	27200614
<b>eCl@ss 10.0</b>	27200614
<b>eCl@ss 11.0</b>	27200614
<b>eCl@ss 12.0</b>	27200614
<b>ETIM 5.0</b>	EC011478

<b>ETIM 6.0</b>	EC011478
<b>ETIM 7.0</b>	EC011478
<b>ETIM 8.0</b>	EC011478
<b>UNSPSC 16.0901</b>	41112410

### Dimensional drawing (Dimensions in mm (inch))

1/4" NPT

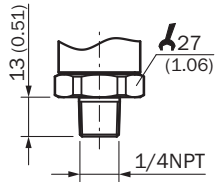

Housing with circular connector M12 x 1, IP67

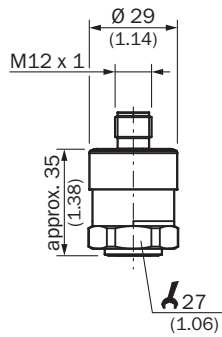



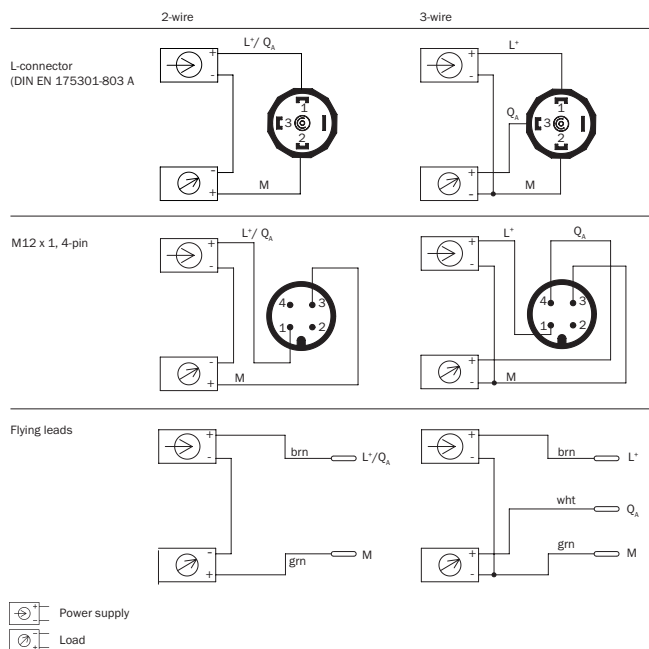



## Connection type



## Recommended accessories

Other models and accessories → [www.sick.com/PBT](http://www.sick.com/PBT)

	Brief description	Type	Part no.
<b>Mounting brackets and plates</b>			
	Mounting bracket for simple and stable wall mounting of pressure sensors with 27 mm hexagon, Aluminum	BEF-FLALUPBS-HLDR	5322501
<b>Plug connectors and cables</b>			
	Head A: female connector, M12, 4-pin, angled Head B: Flying leads Cable: Sensor/actuator cable, PVC, unshielded, 5 m	DOL-1204-W05MD	6020399
	Head A: female connector, M12, 4-pin, straight, A-coded Head B: Flying leads Cable: Sensor/actuator cable, PUR, halogen-free, unshielded, 2 m	YF2A14-020UB3XLEAX	2095607
	Head A: female connector, M12, 4-pin, straight, A-coded Head B: Flying leads Cable: Sensor/actuator cable, PVC, unshielded, 2 m	YF2A14-020VB3XLEAX	2096234
	Head A: female connector, M12, 4-pin, straight, A-coded Head B: Flying leads Cable: Sensor/actuator cable, PVC, unshielded, 5 m	YF2A14-050VB3XLEAX	2096235
	Head A: female connector, M12, 4-pin, straight, A-coded Head B: Flying leads Cable: Sensor/actuator cable, PUR, halogen-free, unshielded, 10 m	YF2A14-100UB3XLEAX	2095609

	<b>Brief description</b>	<b>Type</b>	<b>Part no.</b>
	Head A: female connector, M12, 4-pin, straight, A-coded Head B: Flying leads Cable: Sensor/actuator cable, PVC, unshielded, 10 m	YF2A14-100VB3XLEAX	2096236
	Head A: female connector, M12, 4-pin, straight, A-coded Head B: Flying leads Cable: Sensor/actuator cable, PUR, halogen-free, unshielded, 15 m	YF2A14-150UB3XLEAX	2095610
	Head A: female connector, M12, 4-pin, straight, A-coded Head B: Flying leads Cable: Sensor/actuator cable, PVC, unshielded, 15 m	YF2A14-150VB3XLEAX	2096237
	Head A: female connector, M12, 4-pin, straight, A-coded Head B: Flying leads Cable: Sensor/actuator cable, PUR, halogen-free, unshielded, 20 m	YF2A14-200UB3XLEAX	2095611
	Head A: female connector, M12, 4-pin, straight, A-coded Head B: Flying leads Cable: Sensor/actuator cable, PVC, unshielded, 20 m	YF2A14-200VB3XLEAX	2096238
	Head A: female connector, M12, 4-pin, straight, A-coded Head B: Flying leads Cable: Sensor/actuator cable, PUR, halogen-free, unshielded, 25 m	YF2A14-250UB3XLEAX	2095615
	Head A: female connector, M12, 4-pin, angled, A-coded Head B: Flying leads Cable: Sensor/actuator cable, PUR, halogen-free, unshielded, 2 m	YG2A14-020UB3XLEAX	2095766
	Head A: female connector, M12, 4-pin, angled, A-coded Head B: Flying leads Cable: Sensor/actuator cable, PVC, unshielded, 2 m	YG2A14-020VB3XLEAX	2095895
	Head A: female connector, M12, 4-pin, angled, A-coded Head B: Flying leads Cable: Sensor/actuator cable, PUR, halogen-free, unshielded, 5 m	YG2A14-050UB3XLEAX	2095767
	Head A: female connector, M12, 4-pin, angled, A-coded Head B: Flying leads Cable: Sensor/actuator cable, PVC, unshielded, 5 m	YG2A14-050VB3XLEAX	2095897
	Head A: female connector, M12, 4-pin, angled, A-coded Head B: Flying leads Cable: Sensor/actuator cable, PUR, halogen-free, unshielded, 10 m	YG2A14-100UB3XLEAX	2095768
	Head A: female connector, M12, 4-pin, angled, A-coded Head B: Flying leads Cable: Sensor/actuator cable, PVC, unshielded, 10 m	YG2A14-100VB3XLEAX	2095898
	Head A: female connector, M12, 4-pin, angled, A-coded Head B: Flying leads Cable: Sensor/actuator cable, PUR, halogen-free, unshielded, 15 m	YG2A14-150UB3XLEAX	2095769
	Head A: female connector, M12, 4-pin, angled, A-coded Head B: Flying leads Cable: Sensor/actuator cable, PVC, unshielded, 15 m	YG2A14-150VB3XLEAX	2096213
	Head A: female connector, M12, 4-pin, angled, A-coded Head B: Flying leads Cable: Sensor/actuator cable, PUR, halogen-free, unshielded, 20 m	YG2A14-200UB3XLEAX	2095770
	Head A: female connector, M12, 4-pin, angled, A-coded Head B: Flying leads Cable: Sensor/actuator cable, PVC, unshielded, 20 m	YG2A14-200VB3XLEAX	2096214
	Head A: female connector, M12, 4-pin, angled, A-coded Head B: Flying leads Cable: Sensor/actuator cable, PUR, halogen-free, unshielded, 25 m	YG2A14-250UB3XLEAX	2095771

## SICK AT A GLANCE

SICK is one of the leading manufacturers of intelligent sensors and sensor solutions for industrial applications. A unique range of products and services creates the perfect basis for controlling processes securely and efficiently, protecting individuals from accidents and preventing damage to the environment.

We have extensive experience in a wide range of industries and understand their processes and requirements. With intelligent sensors, we can deliver exactly what our customers need. In application centers in Europe, Asia and North America, system solutions are tested and optimized in accordance with customer specifications. All this makes us a reliable supplier and development partner.

Comprehensive services complete our offering: SICK LifeTime Services provide support throughout the machine life cycle and ensure safety and productivity.

For us, that is “Sensor Intelligence.”

## WORLDWIDE PRESENCE:

Contacts and other locations –[www.sick.com](http://www.sick.com)