

PM3C17-00030000

Mirror columns with protective field height mirror

COLUMNS FOR SAFETY LIGHT CURTAINS

SICK
Sensor Intelligence.

PM3C17-00030000 | Mirror columns with protective field height mirror

COLUMNS FOR SAFETY LIGHT CURTAINS



Ordering information

Type	Part no.
PM3C17-00030000	1043454

Other models and accessories → www.sick.com/Mirror_columns_with_protective_field_height_mirror

Detailed technical data

Features

Model	Mirror columns with protective field height mirror
Type of diversion	Horizontal
Suitable for	Safety light curtains Safety multibeam sensors
Suitable for protective field height	≤ 1,500 mm
Suitable for number of beams	Any
Suitable for beam separation	Any

Mechanical data

Number of mirrors	1
Mirror length	1,532 mm
Mirror width	125 mm
Column height	1,716.5 mm
Dimensional drawing	L1 1,532 mm L2 145 mm L5 1,716.5 mm
Weight	12,650 g

Classifications

eCl@ss 5.0	27279203
eCl@ss 5.1.4	27279203
eCl@ss 6.0	27279203
eCl@ss 6.2	27279203
eCl@ss 7.0	27279203
eCl@ss 8.0	27279203
eCl@ss 8.1	27279203
eCl@ss 9.0	27273601
eCl@ss 10.0	27273601
eCl@ss 11.0	27273601

eCl@ss 12.0	27273601
ETIM 5.0	EC002467
ETIM 6.0	EC002467
ETIM 7.0	EC002467
ETIM 8.0	EC002467
UNSPSC 16.0901	39111609

Dimensional drawing (Dimensions in mm (inch))

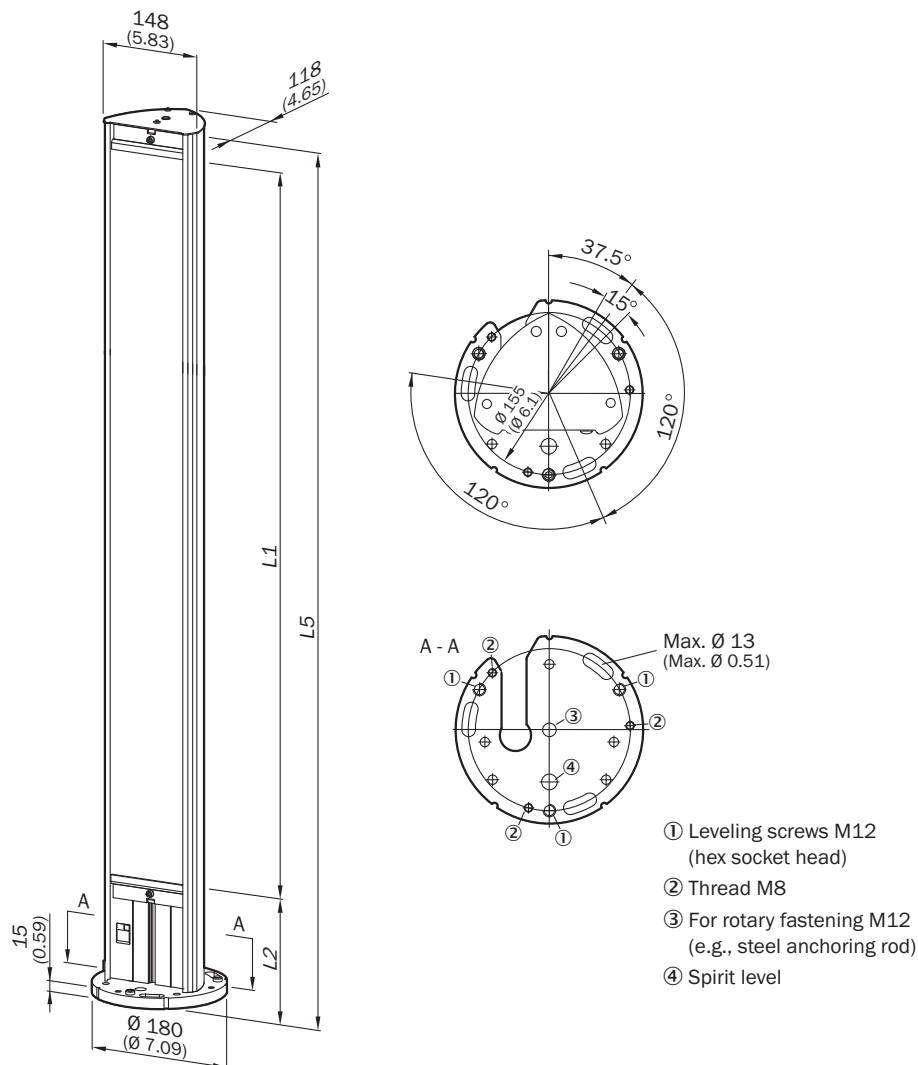

	L1	L2	L5	
≤ 1,050	1,082	160	1,281.5	1043453
≤ 1,350	1,382	145	1,569	1077525
≤ 1,500	1,532	145	1,716.5	1043454
≤ 1,650	1,682	295	2,016.5	1043455
≤ 1,800	1,832	345	2,216.5	1043456
≤ 1,950	1,982	245	2,269	1093216

PM3C17-00030000 | Mirror columns with protective field height mirror

COLUMNS FOR SAFETY LIGHT CURTAINS

	L1	L2	L5	
≤ 2,100	2,132	245	2,419	1093217

SICK AT A GLANCE

SICK is one of the leading manufacturers of intelligent sensors and sensor solutions for industrial applications. A unique range of products and services creates the perfect basis for controlling processes securely and efficiently, protecting individuals from accidents and preventing damage to the environment.

We have extensive experience in a wide range of industries and understand their processes and requirements. With intelligent sensors, we can deliver exactly what our customers need. In application centers in Europe, Asia and North America, system solutions are tested and optimized in accordance with customer specifications. All this makes us a reliable supplier and development partner.

Comprehensive services complete our offering: SICK LifeTime Services provide support throughout the machine life cycle and ensure safety and productivity.

For us, that is “Sensor Intelligence.”

WORLDWIDE PRESENCE:

Contacts and other locations –www.sick.com