



# WTT12L-A2553

PowerProx

MULTITASK PHOTOELECTRIC SENSORS

**SICK**  
Sensor Intelligence.

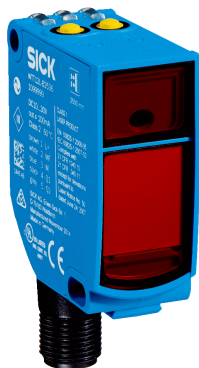

Illustration may differ



### Ordering information

Type	Part no.
WTT12L-A2553	1082475

Other models and accessories → [www.sick.com/PowerProx](http://www.sick.com/PowerProx)

### Detailed technical data

#### Features

<b>Device type</b>	Photoelectric sensors
<b>Sensor/ detection principle</b>	Photoelectric proximity sensor, Background suppression
<b>Dimensions (W x H x D)</b>	20 mm x 49.6 mm x 44.2 mm
<b>Housing design (light emission)</b>	Rectangular
<b>Sensing range max.</b>	50 mm ... 1,800 mm <sup>1)</sup>
<b>Sensing range</b>	100 mm ... 1,800 mm <sup>1) 2)</sup>
<b>Distance value</b>	
Measuring range	100 mm ... 1,800 mm <sup>1)</sup>
Resolution	1 mm
Repeatability	1,2 mm ... 3,0 mm <sup>3) 4) 5)</sup>
Accuracy	Typ. ± 20 mm <sup>6)</sup> Typ. ± 15 mm <sup>7)</sup>
<b>Type of light</b>	Visible red light
<b>Light source</b>	Laser <sup>8)</sup>
<b>Light spot size (distance)</b>	Ø 12 mm (1,800 mm)
<b>Wave length</b>	658 nm
<b>Laser class</b>	1 (IEC 60825-1 / CDRH 21 CFR 1040.10 & 1040.11)

<sup>1)</sup> Object with 6 ... 90 % remission (based on standard white to DIN 5033).

<sup>2)</sup> Adjustable.

<sup>3)</sup> Equivalent to 1  $\sigma$ .

<sup>4)</sup> See characteristic curves repeatability.

<sup>5)</sup> 6 % ... 90 % remission.

<sup>6)</sup> 50 ... 1000 mm.

<sup>7)</sup> 1000 ... 1800 mm.

<sup>8)</sup> Average service life: 100,000 h at T<sub>J</sub> = +25 °C.

<b>Adjustment</b>	Single teach-in button (2 x)
-------------------	------------------------------

- 1) Object with 6 ... 90 % remission (based on standard white to DIN 5033).
- 2) Adjustable.
- 3) Equivalent to 1  $\sigma$ .
- 4) See characteristic curves repeatability.
- 5) 6 % ... 90 % remission.
- 6) 50 ... 1000 mm.
- 7) 1000 ... 1800 mm.
- 8) Average service life: 100,000 h at  $T_U = +25$  °C.

### Mechanics/electronics

<b>Supply voltage</b>	12 V DC ... 30 V DC <sup>1) 2)</sup>
<b>Ripple</b>	< 5 V <sub>pp</sub> <sup>3)</sup>
<b>Current consumption</b>	70 mA <sup>4)</sup>
<b>Switching output</b>	Push-pull: PNP/NPN <sup>5)</sup>
<b>Number of switching outputs</b>	1 (Q <sub>1</sub> ) <sup>5)</sup>
<b>Switching mode</b>	Light switching <sup>5)</sup>
<b>Output current I<sub>max</sub></b>	≤ 50 mA
<b>Response time</b>	≤ 5 ms <sup>6)</sup>
<b>Switching frequency</b>	100 Hz <sup>7)</sup>
<b>Analog output</b>	4 mA ... 20 mA (≤ 450 Ω) / 0 V ... 10 V (≥ 50 kΩ) / switchable
<b>Resolution of analog output</b>	12 bit
<b>Output time</b>	≤ 5 ms
<b>Input</b>	Sender off
<b>Connection type</b>	Male connector M12, 5-pin
<b>Circuit protection</b>	A <sup>8)</sup> B <sup>9)</sup> C <sup>10)</sup>
<b>Protection class</b>	III
<b>Weight</b>	48 g
<b>Housing material</b>	Plastic, VISTAL®
<b>Optics material</b>	Plastic, PMMA
<b>Enclosure rating</b>	IP67
<b>Ambient operating temperature</b>	-35 °C ... +50 °C <sup>11)</sup>

- 1) Limit values. Operated in short-circuit protected network: max. 8 A.
- 2) V<sub>s</sub> min when using the voltage output = 13 V.
- 3) May not exceed or fall below U<sub>v</sub> tolerances.
- 4) Without load. At V<sub>S</sub> = 24 V.
- 5) Q<sub>1</sub> = 1 switching threshold, light switching.
- 6) Signal transit time with resistive load.
- 7) With light/dark ratio 1:1.
- 8) A = V<sub>S</sub> connections reverse-polarity protected.
- 9) B = inputs and output reverse-polarity protected.
- 10) C = interference suppression.
- 11) For V<sub>s</sub> ≤ 24 V. When T<sub>u</sub> = 45 °C or above, a maximum load resistance of 300 Ω ... 450 Ω is permitted on QA.
- 12) Below T<sub>u</sub> = -10 °C a warm-up time is necessary.

<b>Ambient temperature, storage</b>	-40 °C ... +70 °C
<b>Warm-up time</b>	< 15 min <sup>12)</sup>
<b>Initialization time</b>	< 300 ms
<b>UL File No.</b>	NRKH.E181493

- 1) Limit values. Operated in short-circuit protected network: max. 8 A.
- 2)  $V_S$  min when using the voltage output = 13 V.
- 3) May not exceed or fall below  $U_V$  tolerances.
- 4) Without load. At  $V_S = 24$  V.
- 5)  $Q1 = 1$  switching threshold, light switching.
- 6) Signal transit time with resistive load.
- 7) With light/dark ratio 1:1.
- 8) A =  $V_S$  connections reverse-polarity protected.
- 9) B = inputs and output reverse-polarity protected.
- 10) C = interference suppression.
- 11) For  $V_S \leq 24$  V. When  $T_U = 45$  °C or above, a maximum load resistance of 300 Ω ... 450 Ω is permitted on QA.
- 12) Below  $T_U = -10$  °C a warm-up time is necessary.

### Safety-related parameters

<b>MTTF<sub>D</sub></b>	124 years
<b>DC<sub>avg</sub></b>	0 %
<b>T<sub>M</sub> (mission time)</b>	20 years

### Classifications

<b>ECl@ss 5.0</b>	27270904
<b>ECl@ss 5.1.4</b>	27270904
<b>ECl@ss 6.0</b>	27270904
<b>ECl@ss 6.2</b>	27270904
<b>ECl@ss 7.0</b>	27270904
<b>ECl@ss 8.0</b>	27270904
<b>ECl@ss 8.1</b>	27270904
<b>ECl@ss 9.0</b>	27270904
<b>ECl@ss 10.0</b>	27270904
<b>ECl@ss 11.0</b>	27270904
<b>ETIM 5.0</b>	EC002719
<b>ETIM 6.0</b>	EC002719
<b>ETIM 7.0</b>	EC002719
<b>ETIM 8.0</b>	EC002719
<b>UNSPSC 16.0901</b>	39121528

### Connection/pin assignment

<b>Connection type</b>	Male connector M12, 5-pin
------------------------	---------------------------

### Connection diagram

Cd-375

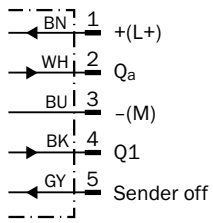

### Characteristic curve

Min. distance from object to background in mm (inch)

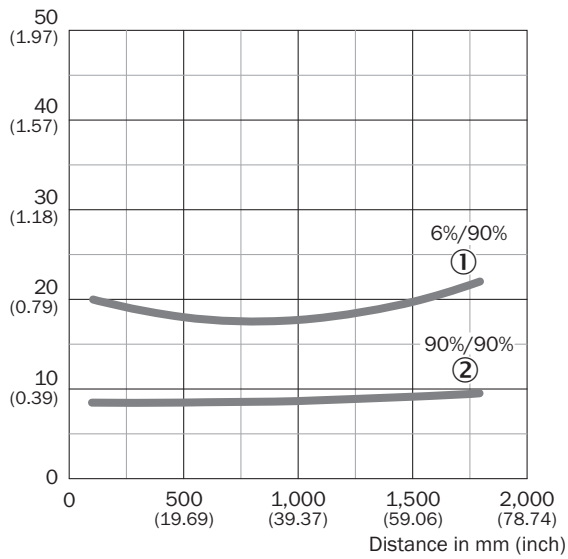

- ① Sensing range on black, 6% remission
- ② Sensing range on white, 90% remission

### Light spot size

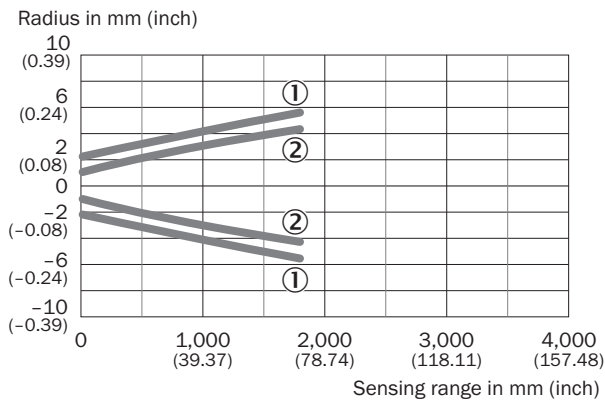

- ① Light spot horizontal
- ② Light spot vertical

## Repeatability

Repeatability in mm (inch)

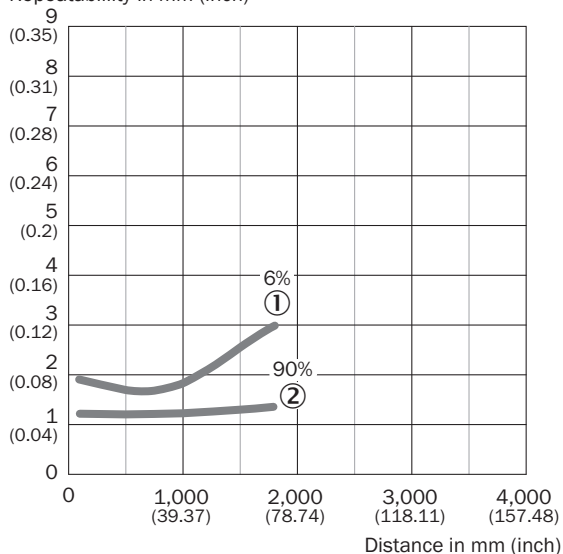

- ① 6 % remission, on black
- ② 90 % remission, on white

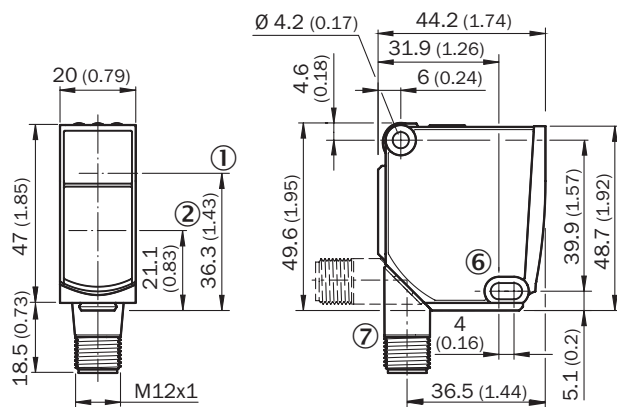

## Dimensional drawing (Dimensions in mm (inch))



- ① Optical axis, sender
- ② Optical axis, receiver
- ③ LED indicator yellow: Status of analog output
- ④ LED indicator green: power on
- ⑤ Status indicator LED, yellow: Status switching output
- ⑥ Mounting hole,  $\varnothing$  4.2 mm
- ⑦ Connection
- ⑧ Single teach-in button

## Recommended accessories

Other models and accessories → [www.sick.com/PowerProx](http://www.sick.com/PowerProx)

	<b>Brief description</b>	<b>Type</b>	<b>Part no.</b>
<b>Plug connectors and cables</b>			
	Head A: female connector, M12, 5-pin, straight, A-coded Head B: Flying leads Cable: Sensor/actuator cable, PVC, unshielded, 5 m	YF2A15-050VB5XLEAX	2096240
	Head A: male connector, M12, 5-pin, straight Cable: unshielded For field bus technology	STE-1205-G	6022083

## SICK AT A GLANCE

SICK is one of the leading manufacturers of intelligent sensors and sensor solutions for industrial applications. A unique range of products and services creates the perfect basis for controlling processes securely and efficiently, protecting individuals from accidents and preventing damage to the environment.

We have extensive experience in a wide range of industries and understand their processes and requirements. With intelligent sensors, we can deliver exactly what our customers need. In application centers in Europe, Asia and North America, system solutions are tested and optimized in accordance with customer specifications. All this makes us a reliable supplier and development partner.

Comprehensive services complete our offering: SICK LifeTime Services provide support throughout the machine life cycle and ensure safety and productivity.

For us, that is “Sensor Intelligence.”

## WORLDWIDE PRESENCE:

Contacts and other locations –[www.sick.com](http://www.sick.com)