



LMS131-10100 Security

LMS1xx

2D LIDAR SENSORS

SICK
Sensor Intelligence.



Ordering information

Type	Part no.
LMS131-10100 Security	1051379

Other models and accessories → www.sick.com/LMS1xx



Detailed technical data

Features

Application	Security, Outdoor
Light source	Infrared (905 nm)
Laser class	1 (IEC 60825-1:2014, EN 60825-1:2014)
Aperture angle	Horizontal 270°
Scanning frequency	25 Hz 50 Hz
Angular resolution	0.25° 0.5°
Heating	Yes
Working range	0.5 m ... 20 m
Scanning range	At 10% remission 18 m At 90% remission 20 m
Amount of evaluated echoes	2
Fog correction	Yes

Mechanics/electronics

Connection type	1 x M12 round connector
Supply voltage	9 V DC ... 30 V DC
Power consumption	Typ. 8 W, heating typ. 35 W
Housing color	Gray (RAL 7032)
Enclosure rating	IP67 (EN 60529, Section 14.2.7)
Protection class	III (EN 50178 (1997;10))
Weight	1.1 kg
Dimensions (L x W x H)	105 mm x 102 mm x 162 mm
MTBF	> 100 years

Safety-related parameters

MTTF_D	> 100 years
-------------------------	-------------

Performance

Response time	≥ 20 ms
Detectable object shape	Almost any
Systematic error	± 30 mm ¹⁾
Statistical error	12 mm ¹⁾
Integrated application	Field evaluation with flexible fields Security conform parameterization Easy Teach lite and pro
Number of field sets	10 fields
Simultaneous evaluation cases	10

¹⁾ Typical value; actual value depends on environmental conditions.

Interfaces

Ethernet	✓, TCP/IP
Remark	OPC DA
Function	Host
Data transmission rate	10/100 MBit/s
Serial	✓, RS-232
Function	AUX
Data transmission rate	9.6 kBaud ... 115.2 kBaud
CAN	✓
Function	Extension of outputs
Digital inputs	4 digital
Digital outputs	3 (2 relay, 1 digital)
Optical indicators	7-segment display (plus 5 LEDs showing device status, contamination warning and initial condition)

Ambient data

Object remission	2 % ... > 1,000 % (reflectors)
Electromagnetic compatibility (EMC)	EN 61000-6-2:2005 / EN 61000-6-3:2007+A1:2011
Vibration resistance	EN 60068-2-6 (1995-04)
Shock resistance	EN 60068-2-27 (1993-03)
Ambient operating temperature	-30 °C ... +50 °C
Storage temperature	-30 °C ... +70 °C
Ambient light immunity	40,000 lx

General notes

Note on use	The sensor does not constitute a safety component as defined by relevant legislation on machine safety.
--------------------	---

Classifications

eCl@ss 5.0	27270990
eCl@ss 5.1.4	27270990
eCl@ss 6.0	27270913

eCl@ss 6.2	27270913
eCl@ss 7.0	27270913
eCl@ss 8.0	27270913
eCl@ss 8.1	27270913
eCl@ss 9.0	27270913
eCl@ss 10.0	27270913
eCl@ss 11.0	27270913
eCl@ss 12.0	27270913
ETIM 5.0	EC002550
ETIM 6.0	EC002550
ETIM 7.0	EC002550
ETIM 8.0	EC002550
UNSPSC 16.0901	41111615

Dimensional drawing (Dimensions in mm (inch))

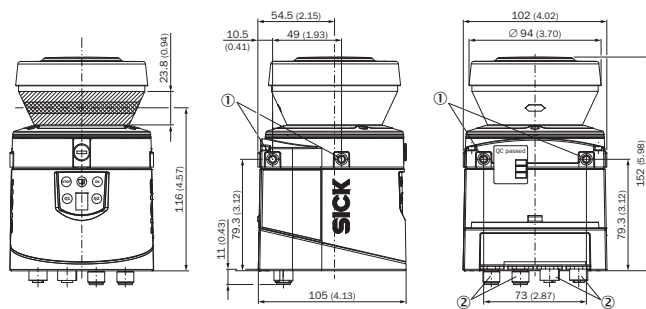

- ① Mounting hole M5 x 7.5
- ② Connector M12

Working range diagram

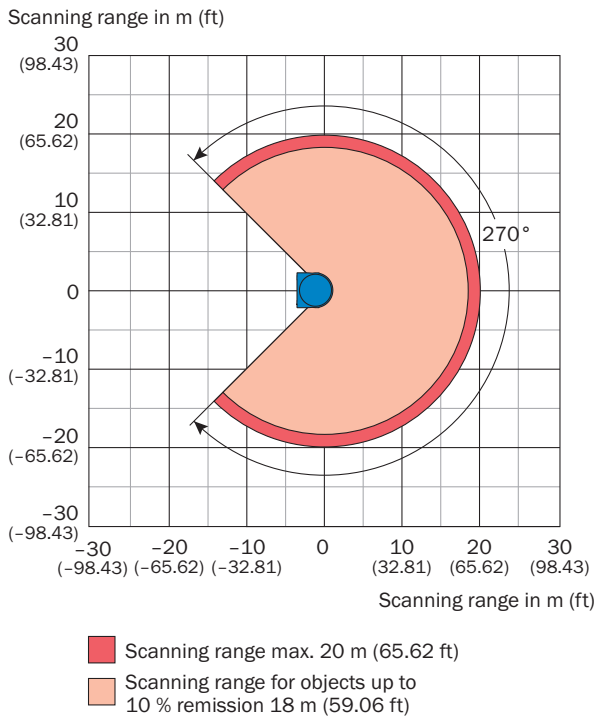

PIN assignment

AUX

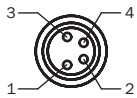











Female connector M8, 4-pin

- ① Reserved
- ② RxD AUX
- ③ GND RS
- ④ TxD AUX

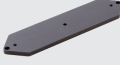
Recommended accessories

Other models and accessories → www.sick.com/LMS1xx

	Brief description	Type	Part no.
Device protection (mechanical)			
	Weather hood, 190°	Weather protection cover 190°	2046459
	Weather hood, 270°	Weather protection cover 270°	2046458

	Brief description	Type	Part no.
Mounting brackets and plates			
	Standard mounting set for weather hood	Mounting bracket	2046025
	1 piece, mounting bracket for rear mounting on wall or machine	Mounting kit 1a	2034324
	1 piece, mounting bracket for rear mounting on wall or machine with protection of optics hood	Mounting kit 1b	2034325
	1 piece, mounting bracket, adjustable lateral axis, only in conjunction with mounting kit 1a (2034324) or 1b (2034325)	Mounting kit 2	2039302
	1 piece, mounting plate, adjustable longitudinal axis, only in conjunction with mounting kit 2 (2039302)	Mounting kit 3	2039303
Plug connectors and cables			
	Head A: female connector, M12, 8-pin, straight, A-coded Head B: Flying leads Cable: Sensor/actuator cable, PUR, halogen-free, shielded, 5 m	YF2A28-050UA6XLEAX	2095835
	Head A: female connector, M12, 5-pin, straight, A-coded Head B: Flying leads Cable: Power, PUR, halogen-free, shielded, 5 m	YF2A64-050XXXLEAX	6036159
	Head A: male connector, M12, 8-pin, straight, A-coded Head B: Flying leads Cable: Sensor/actuator cable, PUR, halogen-free, shielded, 5 m	YM2A28-050UA6XLEAX	6036155
	Head A: male connector, M12, 4-pin, straight, D-coded Head B: male connector, RJ45, 4-pin, straight Cable: Ethernet, PROFINET, PUR, halogen-free, shielded, 5 m	YM2D24-050PN1MRJA4	2106184
Terminal and alignment brackets			
	Quick-action lock system for weather hood	Quick release	2046989

Recommended services

Additional services → www.sick.com/LMS1xx

	Type	Part no.
Maintenance		
<ul style="list-style-type: none"> • Product area: 2D LiDAR sensors, 3D LiDAR sensors • Range of services: Inspection, analysis and restoring of defined functions, Inspection and adaptation of basic settings, parameters of field application, filters for raw data output, and product-specific configuration • Duration: Additional work will be invoiced separately • Travel expenses: The prices do not include travel costs such as hotel, flight, travel time and expenses. 	Maintenance LMS/MRS/NAV/TiM/LRS/multiScan	1682593

	Type	Part no.
Commissioning		
<ul style="list-style-type: none"> • Product area: 2D LiDAR sensors, 3D LiDAR sensors • Range of services: Inspection of connection, fine adjustment, configuration of monitored areas, configuration and optimization of parameters as well as tests, Setup of previously defined functions of basic settings, parameters of field application, filters for raw data output and product-specific configuration • Travel expenses: The prices do not include travel costs such as hotel, flight, travel time and expenses. • Duration: Additional work will be invoiced separately 	Commissioning LMS/MRS/NAV/TiM/LRS/multiScan (Prime package)	1680672
Extended warranty		
<ul style="list-style-type: none"> • Product area: Identification solutions, machine vision, Distance sensors, Detection and ranging solutions • Range of services: The services correspond to the scope of the statutory manufacturer warranty (SICK general terms of delivery). • Duration: Five-year warranty from delivery date. 	Extended warranty for a total of five years from delivery date	1680671

SICK AT A GLANCE

SICK is one of the leading manufacturers of intelligent sensors and sensor solutions for industrial applications. A unique range of products and services creates the perfect basis for controlling processes securely and efficiently, protecting individuals from accidents and preventing damage to the environment.

We have extensive experience in a wide range of industries and understand their processes and requirements. With intelligent sensors, we can deliver exactly what our customers need. In application centers in Europe, Asia and North America, system solutions are tested and optimized in accordance with customer specifications. All this makes us a reliable supplier and development partner.

Comprehensive services complete our offering: SICK LifeTime Services provide support throughout the machine life cycle and ensure safety and productivity.

For us, that is “Sensor Intelligence.”

WORLDWIDE PRESENCE:

Contacts and other locations –www.sick.com